

UNI-7

User's Manual

Ver. 1.02

IMPORTANT

- Read this manual thoroughly, and do not perform installation, operation, maintenance, or inspection unless you fully understand all of the contents.
- Keep this manual in a safe place where you can refer to it easily while installing, operating, and carrying out maintenance or inspections.

ISHIDA CO., LTD.

© ISHIDA Co., Ltd. 2008 All rights are reserved.

No part of this publication may be reproduced, stored in a retrieval system, or transmitted in any form or by any means mechanical, electronic, photocopying, recording, or otherwise without prior written permission of ISHIDA.

NOTICES

IMPORTANT NOTICE

Those who handle the machine must be aware of the hazards involved. These dangers may not be obvious, so it is imperative to follow the instructions detailed in this manual when installing, operating, inspecting, or servicing the machine. Therefore, we recommend that you thoroughly read and understand this manual before installing, operating, inspecting, or servicing the machine. ISHIDA is not liable for any damage, loss or injury that results from incorrect operation, insufficient caution, unauthorized modifications to the machine, or failure to follow the instructions contained in this manual.

LIMITATIONS OF LIABILITY

ISHIDA assumes no responsibility for special, indirect, or consequential damages, loss of profits or commercial loss in any way connected with the machine, whether such claim is based on contract, warranty, negligence, or strict liability.

ISHIDA assumes no responsibility for the user's programming of this machine, or any consequence thereof.

In no event shall ISHIDA be responsible for warranty, repair, or other claims regarding the machine unless ISHIDA's analysis confirms that the machines were properly handled, stored, installed, and maintained and not subject to contamination, abuse, misuse, or inappropriate modification or repair.

CHANGE IN SPECIFICATIONS

Machine specifications and accessories may be changed at any time due to improvements or other reasons. Consult with your ISHIDA representative at any time to confirm the actual specifications of the purchased machine.

ERRORS AND OMISSIONS

The information in this manual has been carefully checked and is believed to be accurate; however, no responsibility is assumed for clerical, typographical or proofreading errors, or omissions.

PRECAUTIONS FOR SAFE USE

It is strongly advised that the following safety measures must be observed to ensure the safe operation of the machine.

WARNING

- **Prepare a dedicated power source and always use a power supply with rated voltage. Never connect the machine power input with an AC power supply exceeding the rated voltage. To avoid any potential electrical shock, ensure that the protective ground wire is connected to the main grounding provision.**

A power supply that generates voltage variation may cause a malfunction, or using the machine outside of the rated voltage may result in machine failure or danger such as electric shock.

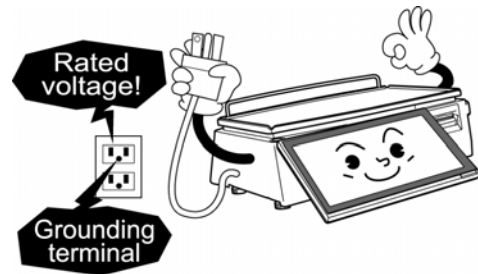

- **Do not install the machine near a TV set or radio.**

Doing so may cause static to the TV set and/or radio as this machine emits weak electric wave.



- **Do not allow water or any liquids to come into contact with the machine.**

Doing so may result in fire or cause the machine to break down.



- **Do not drop or apply a strong shock to the machine.**

Doing so may cause the machine to break down.

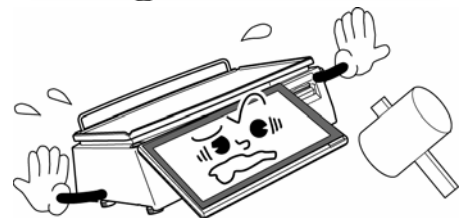

- **Do not disassemble, modify, or attempt to repair the machine.**

Doing so may damage the original safety functions.



- **Do not hold the connector cover when carrying the machine.**

Dropping the machine may result in injury or cause the machine to break down.



 **WARNING**

- **Do not hold the operation panel or weigh platter when carrying the machine.**
Doing so may cause the operation panel or the platter to break down.
- **Do not hold the customer display for the pole type when carrying the machine.**
Dropping the machine may result in injury or cause the machine to break down.
- **Handle with care when removing or inserting the cassette.**
Careless cassette handling may result in injury or cause the cassette to break down.
- **Do not drop the cassette.**
Dropping the cassette may result in injury or cause the cassette to break down.
- **Do not press the touch panel with an edged thing.**
Doing so may scratch the panel and cause the machine to break down.
- **Risk of explosion if battery is replaced by an incorrect type. Make sure to dispose of used batteries according to the instructions.**

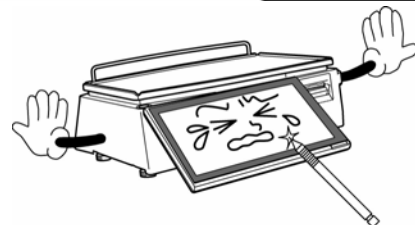
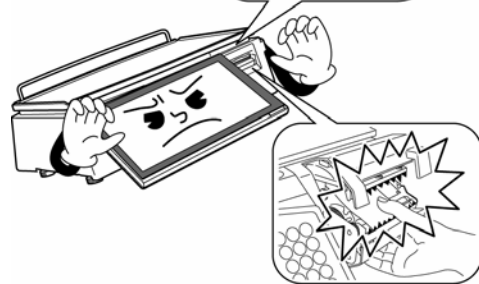
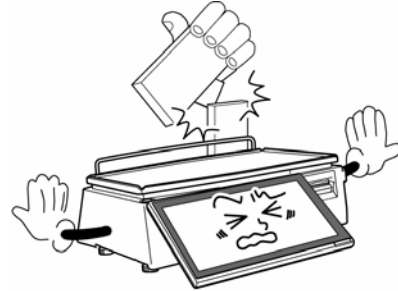
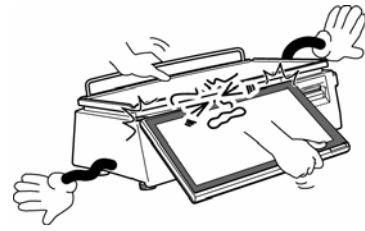

PRECAUTIONS FOR MACHINE INSTALLATION

! WARNING

Do not install the machine in the following types of places:

- Places subject to high temperatures or high humidity
- Places exposed to direct sunlight
- Places where water or other liquids are easily spilled on the machine
- Places subject to excessive vibration or unstable foundations
- Places exposed to direct cold air from air conditioners or refrigerators
- Places where the floor or foundation is unstable
- Places subject to a lot of dust or dirt
- Places with large voltage fluctuations

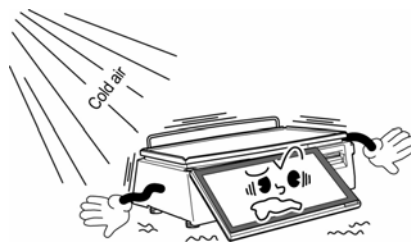

PRECAUTION SYMBOLS

This machine is manufactured for use according to proper procedures by a qualified person and only for the purposes described in this manual. The following conventions are used to indicate and classify precautions depending on the level of danger, or seriousness of potential injury. Always heed the information provided in this manual. Failure to heed precautions can result in personal injury or property damage.

The following precaution symbols are used in this manual.





 WARNING	Indicates a potentially hazardous situation which, if not avoided, may result in serious injury or death. Additionally, there may be significant property damage.
 CAUTION	Indicates a potentially hazardous situation where, if not avoided, may result in minor or moderate injury or in property damage.
 INFOR	Indicates reference information for operation.
 REFER	Indicates the referred page for operation.

TABLE OF CONTENTS

CHAPTER 1 BEFORE USE	1-1
1.1 SPECIFICATIONS	1-1
1.2 MODEL VARIATIONS	1-2
1.3 PART NAMES AND FUNCTIONS	1-3
1.3.1 FRONT VIEW (BENCH TYPE)	1-3
1.3.2 REAR VIEW (BENCH TYPE)	1-3
1.4 OPERATION PANEL	1-4
1.5 ADJUSTMENTS	1-5
1.5.1 LEVEL ADJUSTMENT (BENCH TYPE)	1-5
1.5.2 OPERATION PANEL ANGLE ADJUSTMENT (BENCH TYPE)	1-5
1.6 LABEL / RECEIPT ROLL LOADING	1-6
1.7 REMOVING & REPLACING OF WEIGH PLATTER	1-9
1.7.1 REMOVING THE WEIGH PLATTER	1-9
1.7.2 REPLACING THE WEIGH PLATTER	1-9
1.8 CLEANING OF THE MACHINE	1-10
1.8.1 CLEANING OF THE THEREMAL HEAD	1-10
1.8.2 CLEANING OF THE LABEL SENSOR	1-11
1.8.3 CLEANING OF THE PRINT ROLLER AND PRISM	1-12
1.8.4 PRECAUTIONS WHEN USING CLEANING FLUIDS	1-13
1.9 STARTING PROCEDURES	1-14
1.9.1 TURNING ON THE POWER	1-14
1.9.2 PERFORMING ZERO ADJUSTMENT	1-15
1.9.3 GETTING BACK TO THE INITIAL SCREEN	1-16
CHAPTER 2 LABEL ISSUE	2-1
2.1 LABEL ISSUE WITHOUT OPERATOR	2-1
2.1.1 WEIGHING UNIT PRICE PRODUCTS	2-1
2.1.2 WEIGHING FIXED PRICE PRODUCTS	2-4
2.1.3 PROCESSING FIXED PRICE PRODUCTS	2-7
2.1.4 PROCESSING FIXED WEIGHT/FIXED UNIT PRICE PRODUCTS	2-9
2.2 LABEL ISSUE WITH OPERATORS	2-11
2.2.1 WEIGHING UNIT PRICE PRODUCTS	2-11
2.2.2 WEIGHING FIXED PRICE PRODUCTS	2-14
2.2.3 PROCESSING FIXED PRICE PRODUCTS	2-17
2.2.4 PROCESSING FIXED WEIGHT/FIXED UNIT PRICE PRODUCTS	2-19
CHAPTER 3 RECEIPT ISSUE	3-1
3.1 SALES BY THE SAME OPRATOR	3-1
3.2 SALES BY DIFFERENT OPRATORS	3-11
3.3 VOIDING PRODUCT REGISTRATION	3-24
CHAPTER 4 TRACEABILITY PRODUCTS	4-1
4.1 REFERING TO PREVIOUS TRACEABILITY DATA	4-1

4.2	CHANGING TRACEABILITY DATA	4-4
CHAPTER 5	TEMPORARY CHANGE OPERATIONS	5-1
5.1	UNIT PRICE CHANGE	5-1
5.2	FIXED PRICE CHANGE	5-3
5.3	AMOUNT DISCOUNT FOR UNIT PRICE	5-5
5.4	PERCENT DISCOUNT FOR UNIT PRICE	5-7
5.5	AMOUNT DISCOUNT FOR TOTAL PRICE	5-9
5.6	PERCENT DISCOUNT FOR TOTAL PRICE	5-11
5.7	PRODUCT QUANTITY CHANGE	5-13
5.8	PRINT QUANTITY SETTING.....	5-15
CHAPTER 6	SELF-SERVICE OPERATIONS.....	6-1
6.1	WEIGHING PRODUCTS	6-1
6.2	FIXED PRICE PRODUCTS	6-3
CHAPTER 7	ACCUMULATOR MODE	7-1
7.1	MANUAL INPUT ACCUMULATION	7-1
7.2	WEIGHING ACCUMULATION	7-3
7.3	MANUAL INPUT VOID.....	7-6
7.4	WEIGHING VOID.....	7-9
CHAPTER 8	TOTAL ADJUST MODE	8-1
8.1	MANUAL INPUT SUBTRACTION.....	8-1
8.2	WEIGHING SUBTRACTION.....	8-3
8.3	MANUAL INPUT ADDITION.....	8-6
8.4	WEIGHING ADDITION	8-9
CHAPTER 9	TOTAL MODE.....	9-1
9.1	DAILY TOTAL.....	9-1
9.2	WEEKLY TOTAL	9-4
9.3	CUMULATIVE TOTAL.....	9-6
9.4	TRACEABILITY TOTAL	9-8
9.5	PRESET REPORT PRINTING.....	9-9
9.6	TOTAL CLEAR.....	9-10
CHAPTER 10	PROGRAM MODE	10-1
10.1	PROGRAM MODE ENTRY.....	10-1
10.2	PLU FILE REGISTRATION.....	10-4
10.3	CAMPAIGN LIST REGISTRATION	10-14
10.4	OPERATOR REGISTRATION.....	10-19
10.5	PRESET KEY REGISTRATION.....	10-22
10.5.1	SETTING PRESET FUNCTIONS.....	10-22
10.5.2	ASSIGNING IMAGES ON THE PRESET KEYS	10-25
10.5.3	COLORING PRESET KEYS	10-27
10.5.4	CHANGING PRESET KEY SIZES	10-30

10.5.5	EDITING PRESET KEY NAMES.....	10-33
10.5.6	CONFIRMING PRESET KEY DATA.....	10-36
10.5.7	DELETING PRESET KEYS.....	10-37
10.5.8	MEMBRANE KEYS.....	10-39
10.6	ADVERTISEMENT MESSAGE REGISTRATION.....	10-42
10.7	STORE NAME REGISTRATION.....	10-46
10.7.1	CHANGING EXISTING STORE DATA.....	10-46
10.7.2	CREATING NEW STORE DATA.....	10-49
10.8	DEPARTMENT NAME REGISTRATION.....	10-53
10.8.1	CREATING NEW DEPARTMENT NAMES.....	10-53
10.8.2	CHANGING EXISITING DEPARTMENT NAMES.....	10-57
10.9	GROUP NAME REGISTRATION.....	10-59
10.9.1	CREATING NEW GROUP NAMES.....	10-59
10.9.2	CHANGING EXISITING GROUP NAMES.....	10-62
10.10	COOKING INSTRUCTION REGISTRATION.....	10-64
10.10.1	CREATING NEW INSTRUCTIONS.....	10-64
10.10.2	CHANGING EXISITING INSTRUCTIONS.....	10-67
10.11	NUTRITION FILE REIGISTRATION.....	10-69
10.11.1	CREATING NEW NUTRITION DATA.....	10-69
10.11.2	CHANGING EXISTING NUTRITION DATA.....	10-72
10.12	EXTRA MESSAGE REGISTRATION.....	10-75
10.12.1	CREATING NEW MESSAGES.....	10-75
10.12.2	CHANGING EXISITING MESSAGES.....	10-78
10.13	COUPON MESSAGE REGISTRATION.....	10-80
10.13.1	CREATING NEW MESSAGES.....	10-80
10.13.2	CHANGING EXISITING MESSAGES.....	10-83
10.14	POP MESSAGE REGISTRATION.....	10-85
10.15	TAX REGISTRATION.....	10-87
10.16	SCHEME TABLE REGISTRATION.....	10-88
10.16.1	CREATING NEW TABLES.....	10-88
10.16.2	CHANGING EXISITING MESSAGES.....	10-92
10.17	GEN TABLE REGISTRATION.....	10-96
10.18	LOOKUP TABLE REGISTRATION.....	10-99
10.18.1	CREATING NEW TABLES.....	10-99
10.18.2	CHANGING EXISITING TABLES.....	10-106
10.19	MINCE TRACEABILITY REGISTRATION.....	10-110
10.20	FIXED PRICE MARK REGISTRATION.....	10-111
10.20.1	CREATING NEW PRICE MARKS.....	10-111
10.20.2	CHANGING EXISITING PRICE MARKS.....	10-113
10.21	FREE MESSAGE REGISTRATION.....	10-115
10.21.1	CREATING NEW MESSAGES.....	10-115
10.21.2	CHANGING EXISITING MESSAGES.....	10-118

10.22 CHECK LABEL REGISTRATION.....	10-120
CHAPTER 11 SETUP MODE.....	11-1
11.1 SETUP MODE ENTRY	11-1
11.2 MACHINE NUMBER SETTING	11-3
11.3 SALES MODE SETTING	11-4
11.4 PASSWORD SETTING.....	11-5
11.5 KEY LOCK SETTING	11-10
11.6 DATA STORAGE SETTING	11-14
11.7 PRESET REPORT SETTING	11-15
11.8 AUTO PROGRAM SETTING	11-19
11.9 DEFAULT DATA SETTING.....	11-21
11.10 PLU UPDATE SETTING	11-29
11.11 RECEIPT SETTING.....	11-35
CHAPTER 12 ADJUSTMENT MODE	12-1
12.1 ADJUSTMENT MODE ENTRY	12-1
12.2 DATE / TIME ADJUSTMENT	12-2
12.3 TOUCH PANEL ADJUSTMENT	12-4
12.4 DISPLAY CHECK	12-6
APPENDIX TEXT EDITING	A-1
A.1 OPERATION PANEL AND KEY FUNCTIONS	A-1
A.2 NORMAL CHARACTER EDITING	A-3
A.3 SPECIAL CHARACTER EDITING	A-6
A.4 LINE DELETION.....	A-8
A.5 CHARACTER DELETION.....	A-9
A.6 CHARACTER BACKSPACING	A-11

BEFORE USE**1.1 SPECIFICATIONS**

Items	Descriptions
Use conditions	Temperature: 5 to 35°C Humidity: 30 to 85%, Non condensing.
Power supply:	AC100 – 240V, 50 / 60Hz
Power consumption	1.0A/0.5A
Weight	Bench type: Approx.11.5 kg Pole type: Approx.12.5 kg
Weighing capacity	15 kg: 0 to 6/0.002 kg, 6 to 15/0.005 kg
Weighing accuracy	1/3000
Operator/Customer display	7.0 inch color liquid crystal with back light, 480 X 234dots
Printing method	Direct thermal method
Thermal head	2 inches (448dots) and 8 dots/mm
Printing speed	100mm/second, 120mm/second <i>Note: The printing speed may vary according to label conditions.</i>
Printing effective size	56mm
Label size	Label width: 30mm to 60mm Label length: 20mm to 150mm
Number of label cassettes	7 cassettes
Input/Output	LAN 1 channel USB 1 channel CF 1 channel Drawer 2 channels
Program store medium	Flash ROM (32M bytes)

1.2 MODEL VARIATIONS

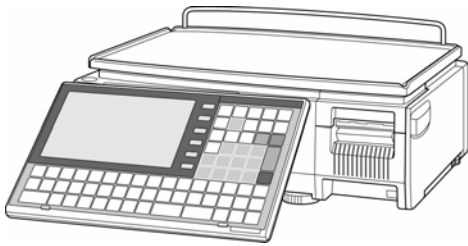

Bench Type

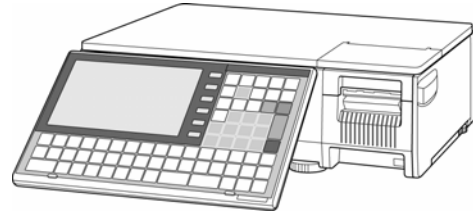

Bakery Type

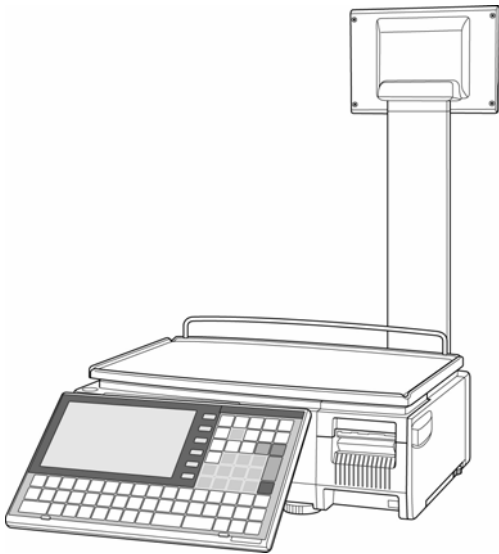

Pole Type

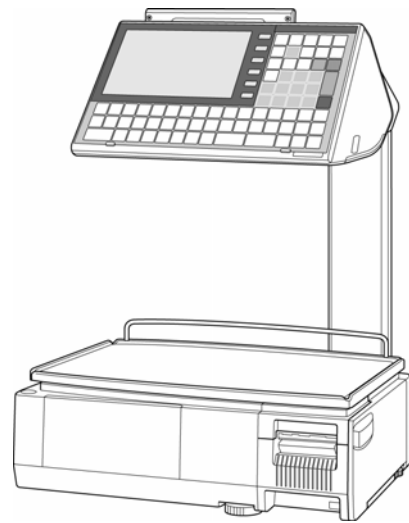

Elevated Type

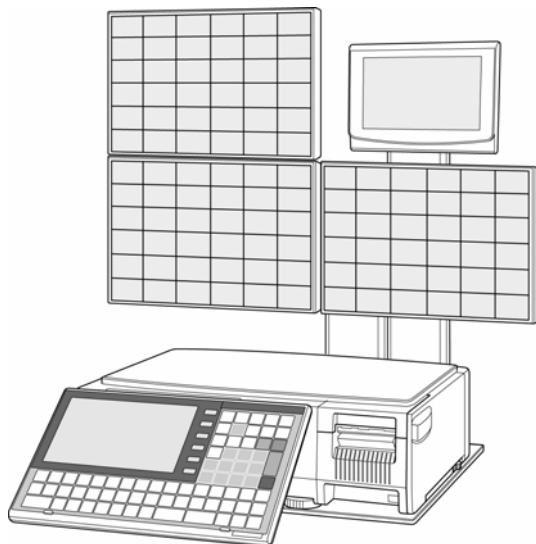

Self-service Type

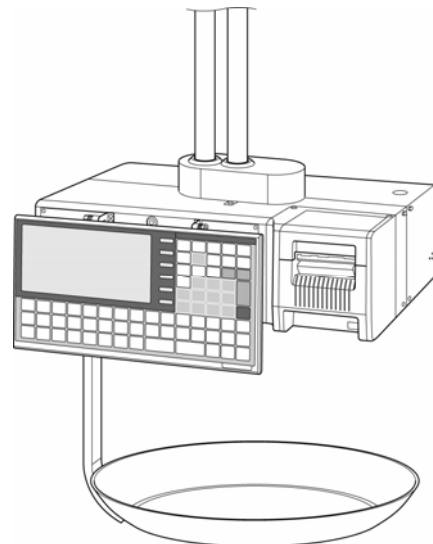

Hanging Type

1.3 PART NAMES AND FUNCTIONS

1.3.1 FRONT VIEW (BENCH TYPE)

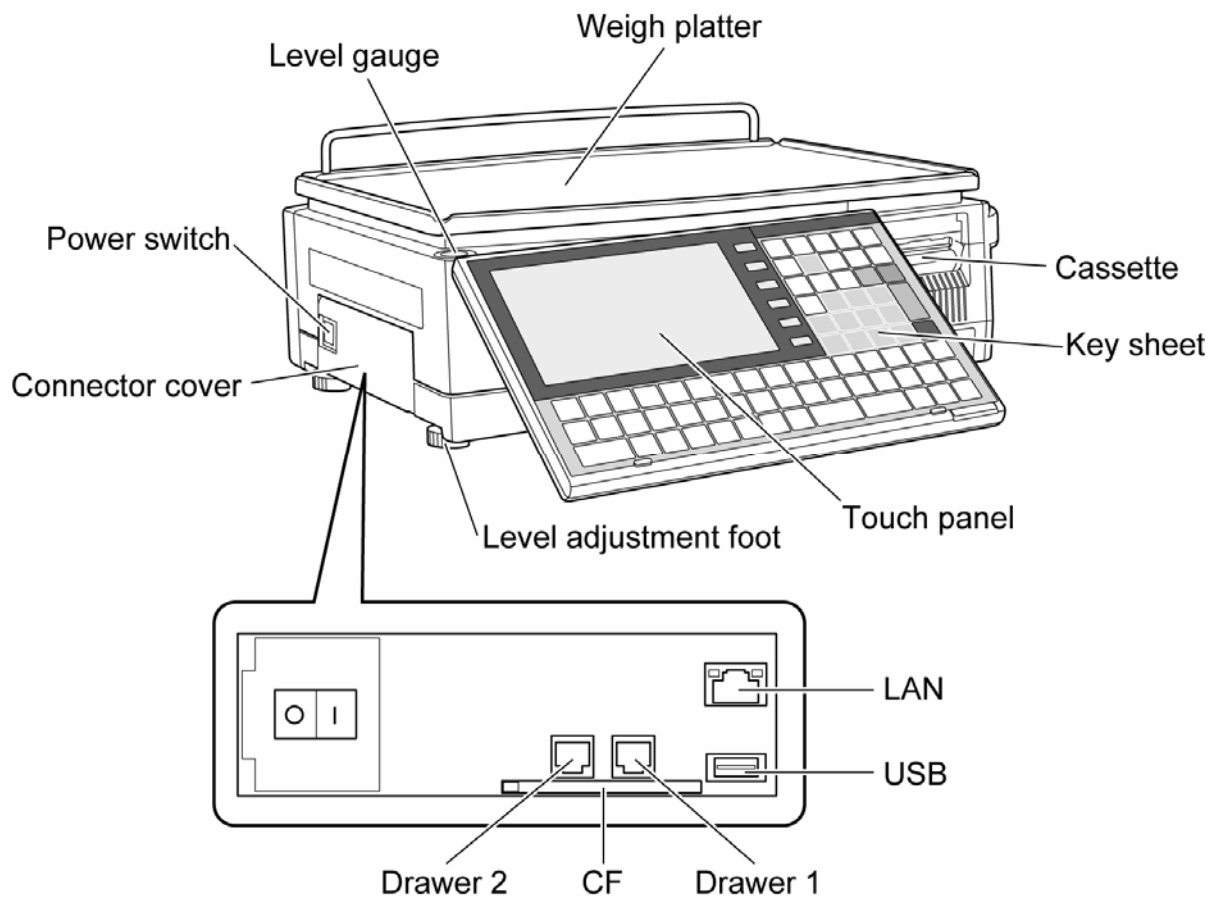



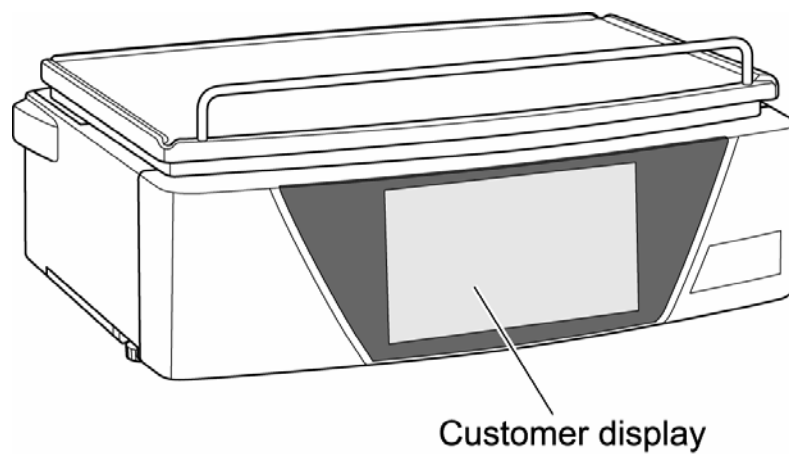



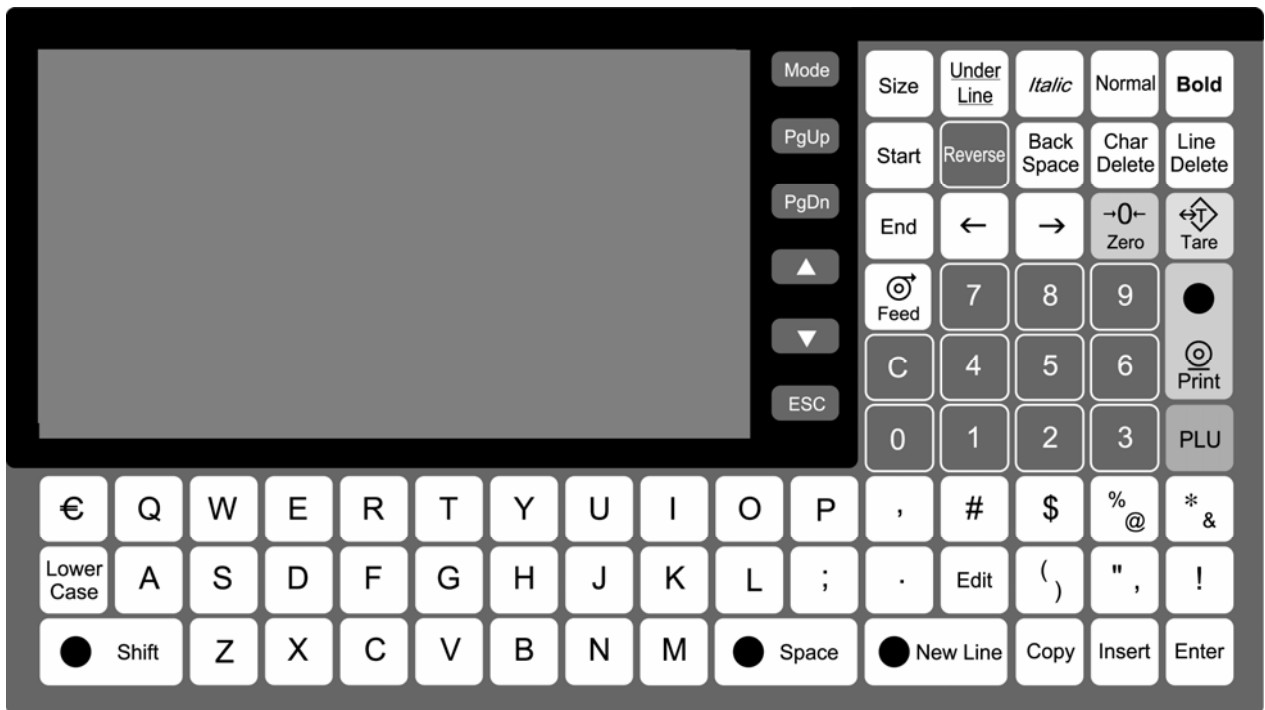





1.3.2 REAR VIEW (BENCH TYPE)



1.4 OPERATION PANEL



■ Keys for Usual Use

	Used to delete an entered numerical value.		Used to display Menu Select screen.
	Used to call a registered product data.		Used to turn the previous page.
	Used to feed labels.		Used to turn the next page.
	Used to issue a label.		Used to jump to the top page.
	Used to enter tare weight.		Used to jump to the end page.
	Used to reset a weigh to zero.		Used to escape from the current mode.

1.5 ADJUSTMENTS

1.5.1 LEVEL ADJUSTMENT (BENCH TYPE)

CAUTION Install the machine horizontally to use.

Be sure to turn off the power switch before placing the machine on a stable platform, and adjust the machine inclination by turning the four level adjustment feet so that the bubble is located at the center of the level gauge. Accurate measurements cannot be performed if it is not installed horizontally.

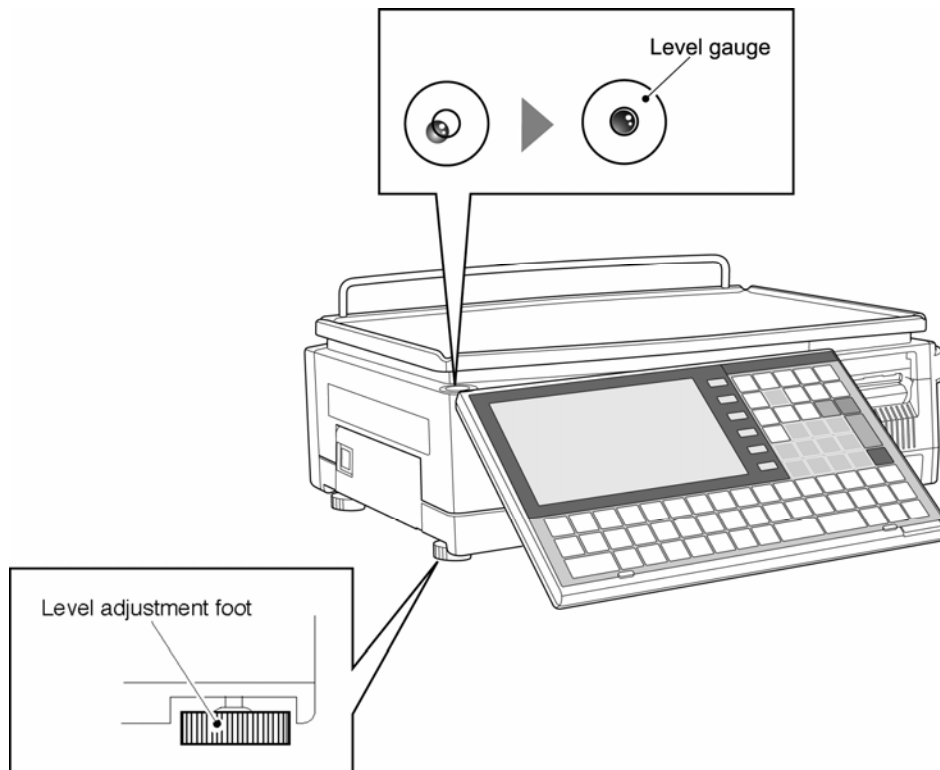

1.5.2 OPERATION PANEL ANGLE ADJUSTMENT (BENCH TYPE)

To obtain a better view, adjust the angle of the operation panel within the range between 0 and 70 degrees.

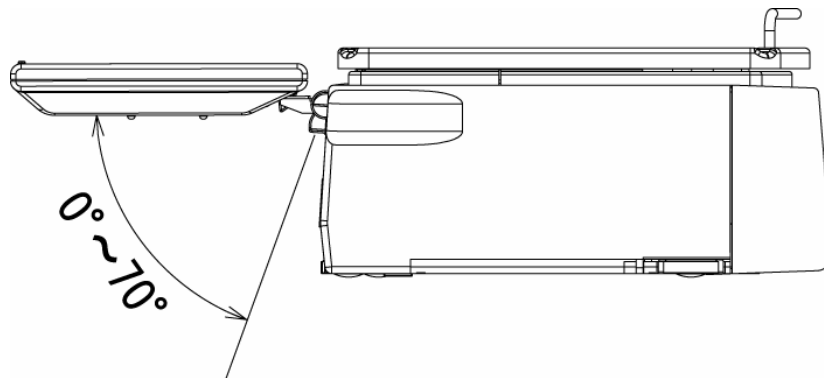

1.6 LABEL / RECEIPT ROLL LOADING

1. Pull out the cassette from the main body.

CAUTION

Before pulling out the cassette unit, ensure that nothing is placed on the weigh platter.

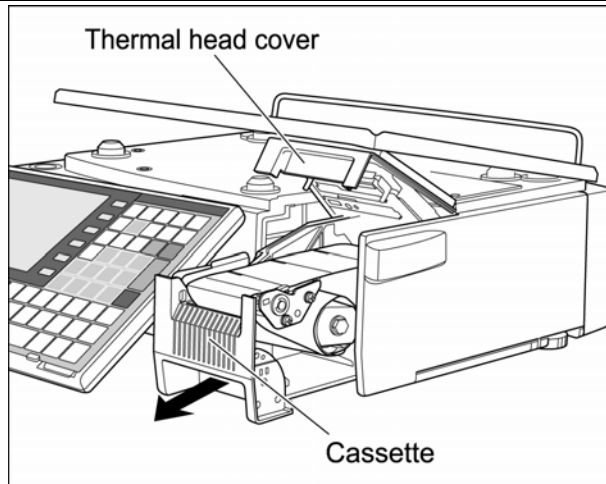

2. Set a new roll around the roll holder and raise the roll stopper to fix the roll position.

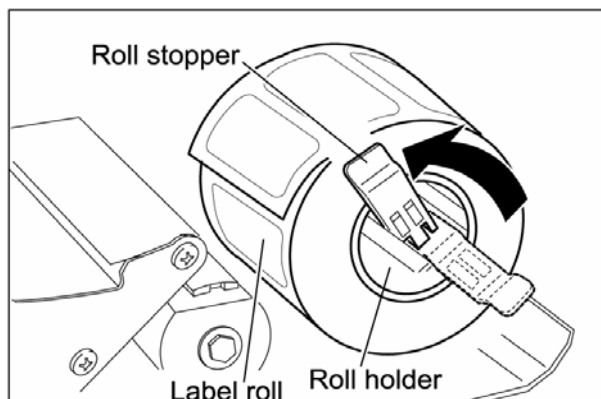

3. Thread the paper as shown in the figures below..

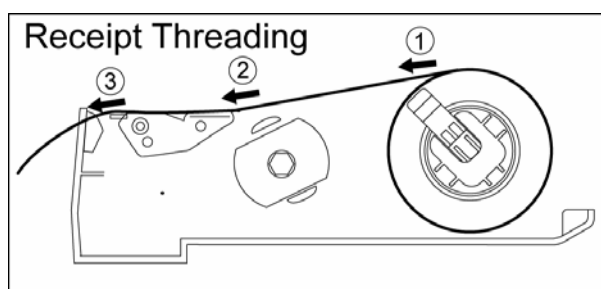
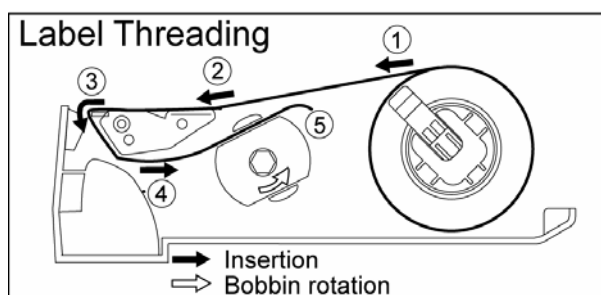

- 4 For labels, fix the paper end with the backing paper stopper, and gently turn the winding bobbin counterclockwise until the label becomes tight.

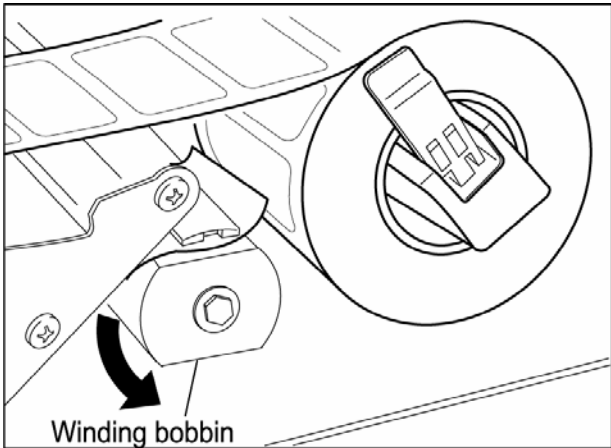

- 5. Slide the label/receipt guide to help smooth paper feeding according to the paper width.

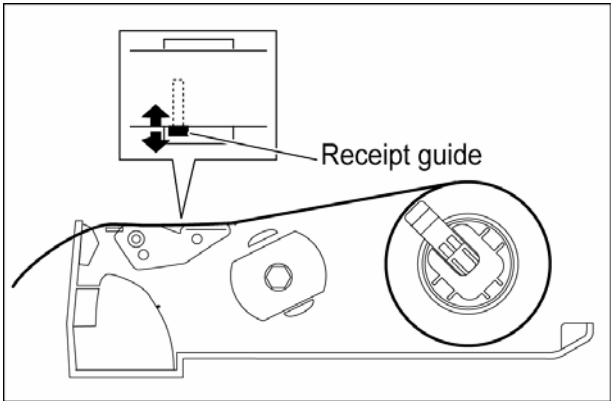
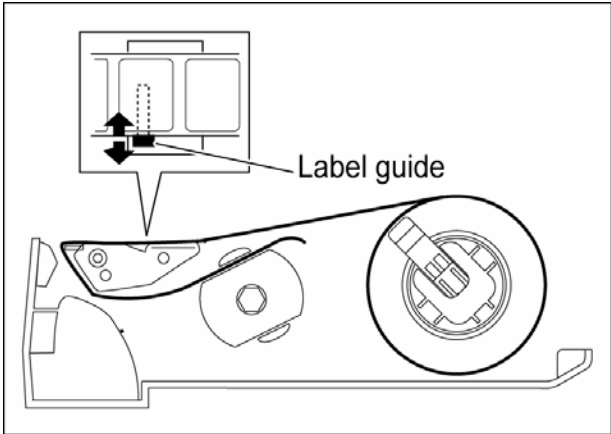

6. Push the cassette straight into the main body to return to its original position.

CAUTION

- Before inserting the cassette unit into the main body, ensure that nothing sticks to the magnet on the bottom of the cassette unit.
- Push the cassette slowly into the main body so as not to get your fingers caught.

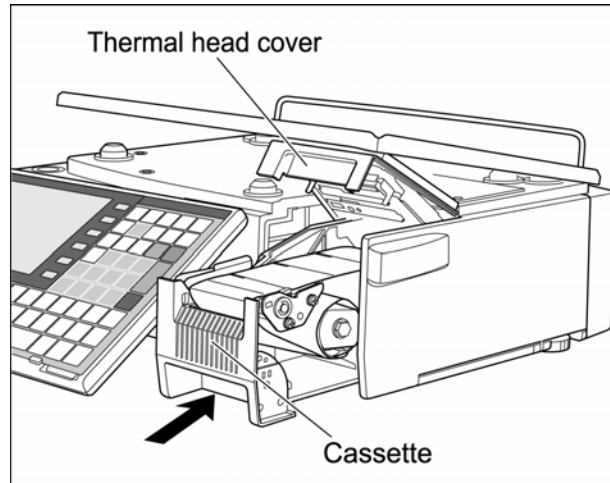

7. For labels, press the [FEED] key on the key sheet to issue a label. At this time, confirm that the label is completely peeled off.

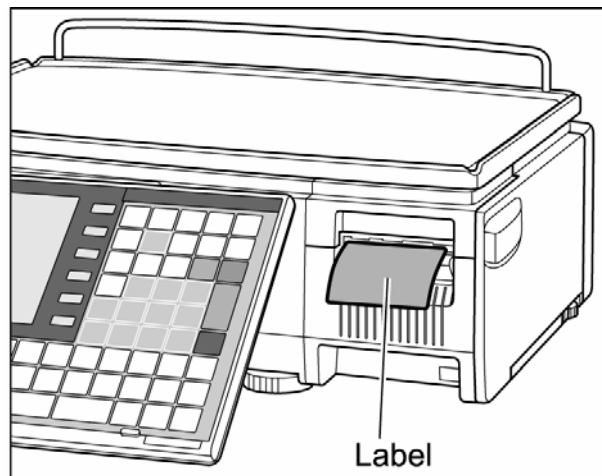

CAUTION

Confirm that the backing paper is wound up smoothly. If the backing paper is wound up diagonally, check that the label is set correctly.

1.7 REMOVING & REPLACING OF WEIGH PLATTER

1.7.1 REMOVING THE WEIGH PLATTER

When removing the weigh platter from the main body, lift the front side to pull out the two pins from the two rubber platter holders and remove the platter by pulling it to disengage the two hooks at the rear side of the platter.

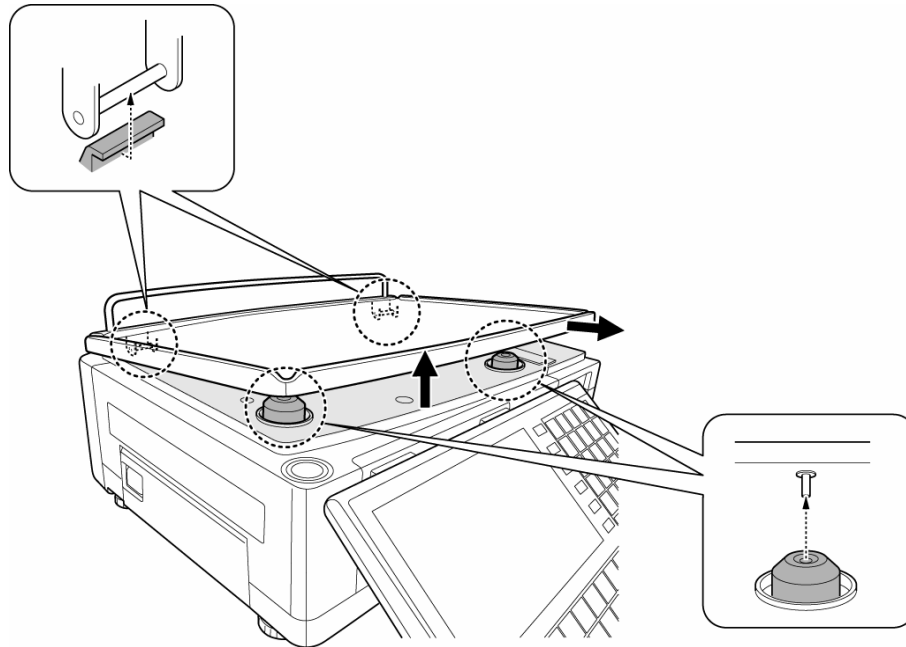

1.7.2 REPLACING THE WEIGH PLATTER

When replacing the weigh platter onto the main body, engage the two hooks at the rear side of the platter and lower the platter so that the two pins on the bottom of the platter are inserted into holes of the rubber platter holders.

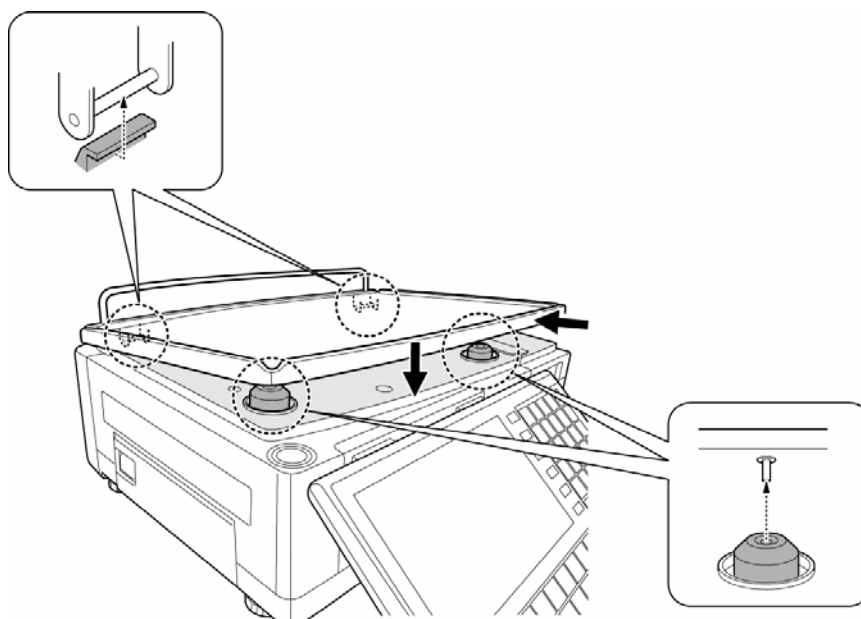

1.8 CLEANING OF THE MACHINE

1.8.1 CLEANING OF THE THERMAL HEAD

1. Pull out the cassette from the main body.

CAUTION

Before pulling out the cassette unit, ensure that nothing is placed on the weigh platter.

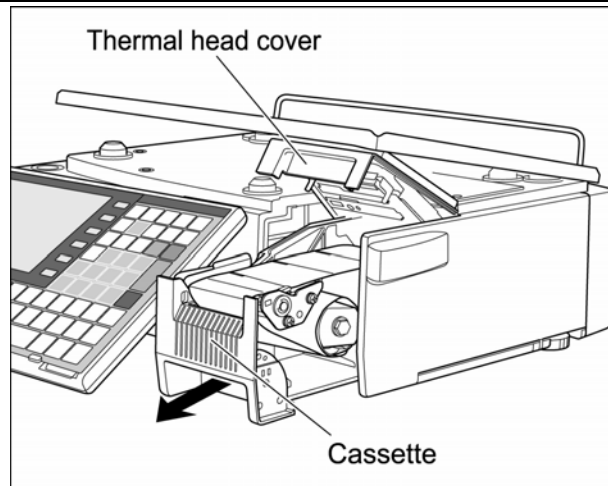

2. Use a cotton-tipped swab to clean off the thermal head.

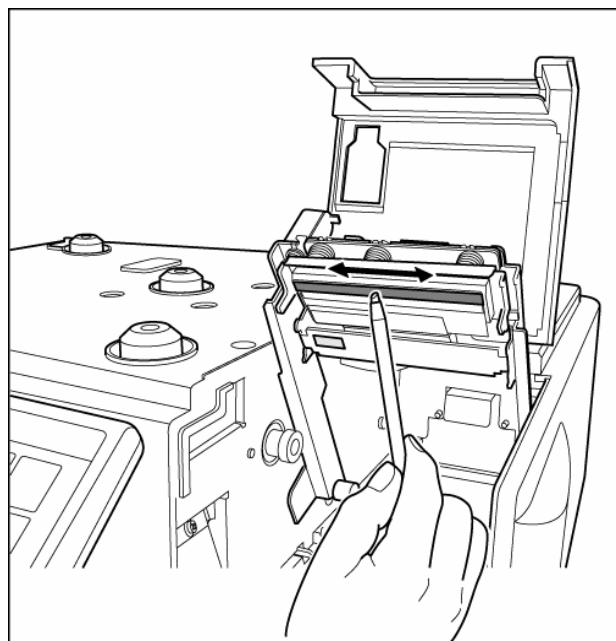

1.8.2 CLEANING OF THE LABEL SENSOR

1. Pull out the cassette from the main body.

CAUTION

Before pulling out the cassette unit, ensure that nothing is placed on the weigh platter.

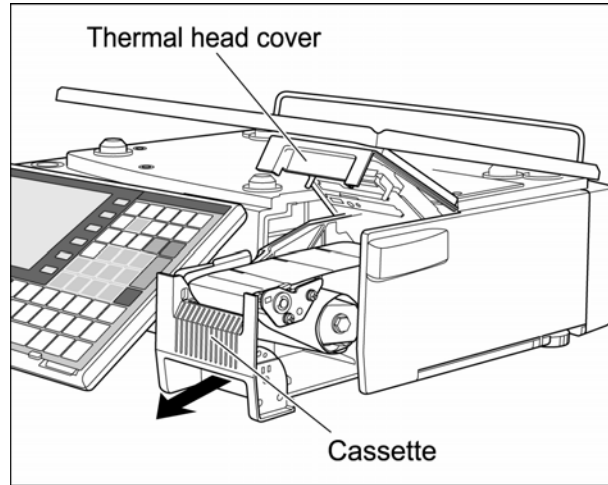

2. Use a dry cloth to clean off the emitter and receiver of the label sensor.

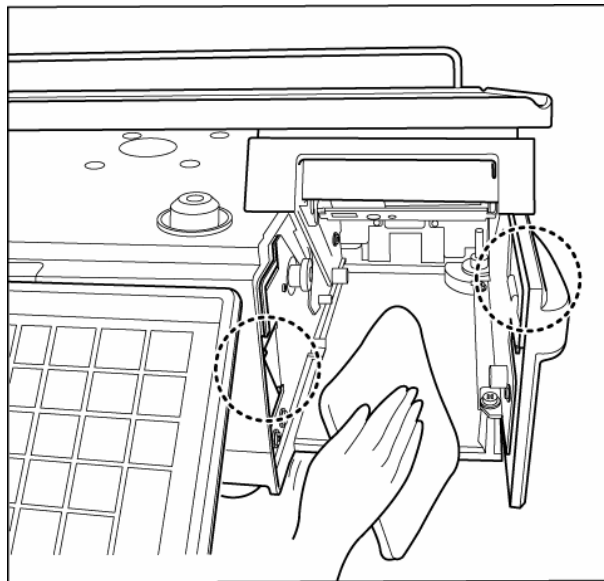

1.8.3 CLEANING OF THE PRINT ROLLER AND PRISM

1. Pull out the cassette from the main body.

CAUTION

Before pulling out the cassette unit, ensure that nothing is placed on the weigh platter.

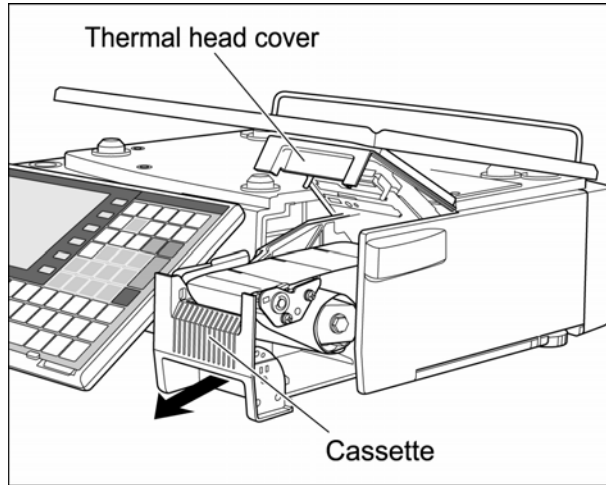

2. Use a dry cloth to clean off the print roller and prism.

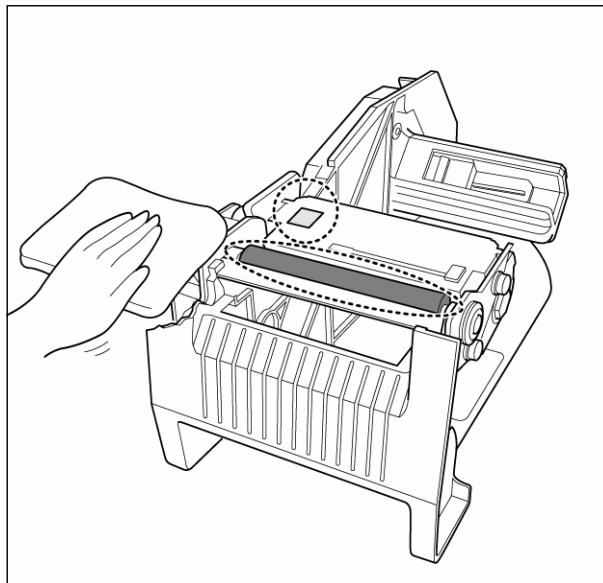

1.8.4 PRECAUTIONS WHEN USING CLEANING FLUIDS

CAUTION

Use a soft cloth and a neutral detergent to clean the machine.
Do not use thinner, benzene, etc. Doing so may damage the original safety functions.
For some parts, use cleaning fluid (isopropyl alcohol).



CAUTION

- Do not use cleaning fluid near fire as the fluid is flammable.
- Do not use cleaning fluid in a poorly ventilated area. Always provide adequate ventilation when cleaning.

Take the following actions in the event of an accident:

If the fluid gets in your eye

- Immediately wash your eye(s) with water for at least 15 minutes, and consult your doctor.
- If you wear contact lenses, remove and wash them.

If the fluid comes into contact with your skin

- Immediately rinse the area of contact with water, and then wash with soap.
- If you notice any skin abnormalities at the area of contact, or if any pain persists, consult your doctor.

If the fumes of the fluid are inhaled

- Immediately move the victim to an area where fresh air is available, and have the victim lie down and keep warm.
- If breathing becomes difficult or stops, provide artificial respiration and seek medical attention immediately.

If the fluid is swallowed

- Do not try to induce vomiting.
- Do not give the victim anything to drink, and do not rinse the mouth.
- If vomiting occurs naturally, have the victim lean forward to reduce risk of aspiration.
- Keep the victim warm and seek medical attention.

1.9 STARTING PROCEDURES

1.9.1 TURNING ON THE POWER

1. Push down the "I" side of the Power Switch to turn on the power.

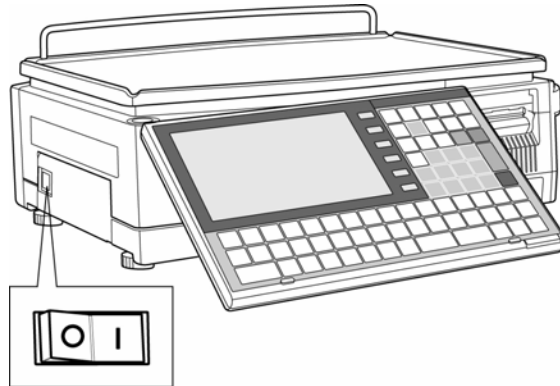

2. The Time Check screen appears. Then, check that displayed date and time agree with current date and time, and press the [ENTER] button on the screen to proceed to the next step.

Note: Refer to "Time/Date Set" menu in Adjust Mode when changing the date or time.

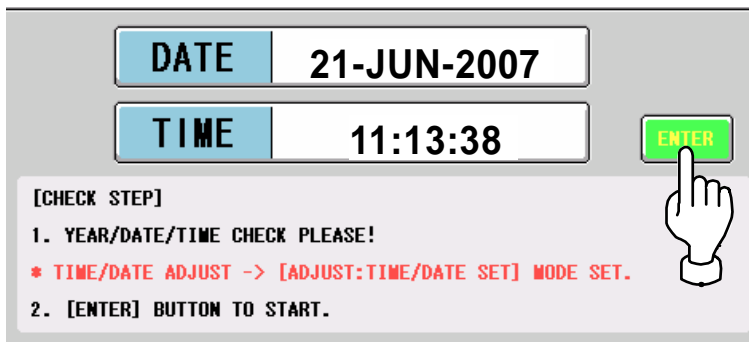

3. After a while, the initial screen appears.

PLU 0					21-JUN-2007(THU) 11:13		TARE	kg	0.000			
					Check the weight before operation. Enter PLU No. and press [PLU] key.					WEIGHT	kg	0.000
PLU No.					PRN MD.							
0	RIB STEAK	TOP SIRLOIN WHOLE	ROUND STEAK BONELESS	PORK CHOP'S BONELESS	SMOKED SAUSAGE							
	ROAST BEEF	T-BONE STEAK	GROUND BEEF EXTRA	MAINE LOBSTER FRESH	SALMON FILLET GARARANTE	UNIT PRICE	£/kg	0.00				
CASSETTE	HAM SANDWICH	HOT SWEET & SOUR WIN	TILAPIA FILLET SKIN-ON	VOID								
1					VOID	TOTAL PRICE	£	0.00				

1.9.2 PERFORMING ZERO ADJUSTMENT

1. If the weight value is not zero on the initial screen,

PLU 0					21-JUN-2007(THU) 11:15		TARE	kg	0.000
Check the weight before operation. Enter PLU No. and press [PLU] key.							WEIGHT	kg	0.000
PLU No.				PRN MD.					
0				<MANUAL>					
RIB STEAK	TOP SIRLOIN WHOLE	ROUND STEAK BONELESS	PORK CHOPS BONELESS	SMOKED SAUSAGE	UNIT PRICE	£/kg	0.00		
ROAST BEEF	T-BONE STEAK	GROUND BEEF EXTRA	MAINE LOBSTER FRESH	SALMON FILLET GUARANTE	TOTAL PRICE	£	0.00		
CASSETTE	HAM SANDWICH	HOT SWEET & SOUR WIN	TILAPIA FILLET SKIN-ON	VOID					
1									

Press the [ZERO] key on the key sheet to perform zero weight adjustment.



2. The "ZERO" indicator lights up and the weight value becomes zero.

PLU 0					21-JUN-2007(THU) 11:15		TARE	kg	0.000	
Check the weight before operation. Enter PLU No. and press [PLU] key.							ZERO	WEIGHT	kg	0.000
PLU No.				PRN MD.						
0				<MANUAL>						
RIB STEAK	TOP SIRLOIN WHOLE	ROUND STEAK BONELESS	PORK CHOPS BONELESS	SMOKED SAUSAGE	UNIT PRICE	£/kg	0.00			
ROAST BEEF	T-BONE STEAK	GROUND BEEF EXTRA	MAINE LOBSTER FRESH	SALMON FILLET GUARANTE	TOTAL PRICE	£	0.00			
CASSETTE	HAM SANDWICH	HOT SWEET & SOUR WIN	TILAPIA FILLET SKIN-ON	VOID						
1										

1.9.3 GETTING BACK TO THE INITIAL SCREEN

1. To get back to the initial screen from a Menu Select screen, press either the “SALES” field or the icon at the bottom right on the screen.

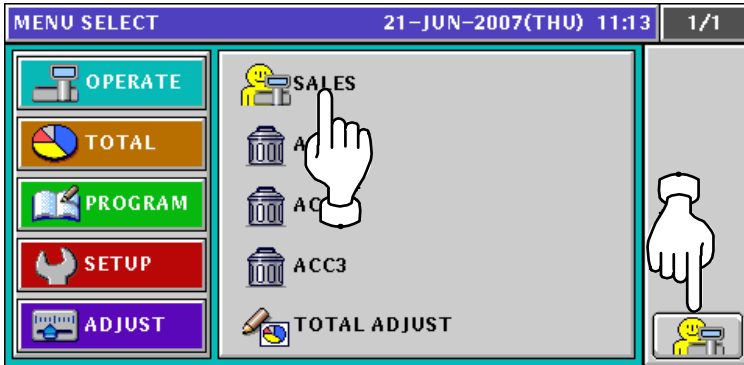

2. The initial screen appears.

PLU 0					21-JUN-2007(THU) 11:13		TARE	kg
Check the weight before operation. Enter PLU No. and press [PLU] key.							0.000	
							WEIGHT	kg
							0.000	
PLU No.				PRN MD.				
0				<MANUAL>	UNIT PRICE	£/kg		
RIB STEAK	TOP SIRLOIN WHOLE	ROUND STEAK BONELESS	PORK CHOPS BONELESS	SMOKED SAUSAGE	0.00			
ROAST BEEF	T-BONE STEAK	GROUND BEEF EXTRA	MAINE LOBSTER FRESH	SALMON FILLET GARANTE	TOTAL PRICE		£	
CASSETTE	HAM SANDWICH	HOT SWEET & SOUR WIN	TILAPIA FILLET SKIN-ON	VOID	0.00			
1								

LABEL ISSUE

2.1 LABEL ISSUE WITHOUT OPERATOR

2.1.1 WEIGHING UNIT PRICE PRODUCTS

1. Ensure that the initial screen is displayed.

PLU 0					21-JUN-2007(THU) 11:15					TARE	kg	0.000	
Check the weight before operation. Enter PLU No. and press [PLU] key.										ZERO	WEIGHT	kg	0.000
PLU No.					PRN MD.								
0					<MANUAL>								
RIB STEAK	TOP SIRLOIN WHOLE	ROUND STEAK BONELESS	PORK CHOPS BONELESS	SMOKED SAUSAGE									
ROAST BEEF	T-BONE STEAK	GROUND BEEF EXTRA	MAINE LOBSTER FRESH	SALMON FILLET GARARANTE									
CASSETTE	HAM SANDWICH	HOT SWEET & SOUR WIN	TILAPIA FILLET SKIN-ON	VOID									
1													
										UNIT PRICE	£/kg	0.00	
										TOTAL PRICE	£	0.00	

2. Enter a desired PLU number using the numeric keys and press the [PLU] key on the key sheet, or simply press a preset key on the screen where the product is allocated.

EXAMPLE PLU No.6 "Roast Beef"

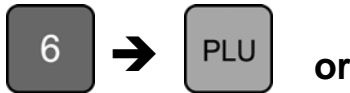

PLU 0					21-JUN-2007(THU) 11:15					TARE	kg	0.000	
Check the weight before operation. Enter PLU No. and press [PLU] key.										ZERO	WEIGHT	kg	0.000
No.					PRN MD.								
6					<MANUAL>								
RIB STEAK	TOP SIRLOIN WHOLE	ROUND STEAK BONELESS	PORK CHOPS BONELESS	SMOKED SAUSAGE									
ROAST BEEF	T-BONE STEAK	GROUND BEEF EXTRA	MAINE LOBSTER FRESH	SALMON FILLET GARARANTE									
CASSETTE	HAM SANDWICH	HOT SWEET & SOUR WIN	TILAPIA FILLET SKIN-ON	VOID									
1													
										UNIT PRICE	£/kg	0.00	
										TOTAL PRICE	£	0.00	

3. When the product is preset as a traceable item, the traceability screen appears. See Chapter 4 for more details about traceability products.
4. The selected PLU screen appears.

Without Preset Tare Weight

PLU 6					21-JUN-2007(THU) 11:15					TARE	kg	0.000	
ROAST BEEF										ZERO	WEIGHT	kg	0.000
U/P	F/P	FIX UPR	FIX UPR +WEIGHT	COUPONMS									
				0									
SPECIAL	-\$	-%	SP. (U/P)	-\$ (U/P)									
0.00	0.00	0.0	0.00	0.00									
-%(U/P)	P DATE	S DATE	TOTALADD	PRN QTY									
0.0	21-06-07	27-06-07	<ADD>	0									
PRN MD.	PEEL MD.	CASSETTE	MULTI	FUNCTION GROUP									
<MANUAL>	<INDIV>	1											
										UNIT PRICE	£/kg	4.00	
										TOTAL PRICE	£	0.00	

With Preset Tare Weight

PLU 6 21-JUN-2007(THU) 11:15					NET	PT	kg
ROAST BEEF					0.050		
					ZERO	WEIGHT	kg
					-0.050		
U/P	F/P	FIX UPR	FIX UPR +WEIGHT	COUPONMS	UNIT PRICE £/kg		
0.00	0.00	0.0	0.00	0	4.00		
-%(U/P)	P DATE	S DATE	TOTALADD	PRN QTY	TOTAL PRICE £		
0.0	21-06-07	27-06-07	<ADD>	0	0.00		
PRN MD.	PEEL MD.	CASSETTE	MULTI	FUNCTION GROUP			
<MANUAL>	<INDIV>	1					

Manual Tare Entry

To newly enter a tare weight or overwrite an existing tare weight, enter the tare weight using the numeric keys and press the "TARE" field on the screen.

EXAMPLE Tare weight "50g"

5

0

PLU 6 21-JUN-2007(THU) 11:15					NET	PT	kg
ROAST BEEF					0.050		
					ZERO	WEIGHT	kg
					-0.050		
U/P	F/P	FIX UPR	FIX UPR +WEIGHT	COUPONMS	UNIT PRICE £/kg		
0.00	0.00	0.0	0.00	0	4.00		
-%(U/P)	P DATE	S DATE	TOTALADD	PRN QTY	TOTAL PRICE £		
0.0	21-06-07	27-06-07	<ADD>	0	0.00		
PRN MD.	PEEL MD.	CASSETTE	MULTI	FUNCTION GROUP			
<MANUAL>	<INDIV>	1					



5. See Chapter 5 for more details about temporary change operations.

6. Put a product on the weigh platter.



The weight is measured and the total price is calculated.

PLU 6 21-JUN-2007(THU) 11:15					TARE	kg
ROAST BEEF					0.000	
					WEIGHT	kg
					0.422	
U/P	F/P	FIX UPR	FIX UPR +WEIGHT	COUPONMS	UNIT PRICE £/kg	
0.00	0.00	0.0	0.00	0	4.00	
-%(U/P)	P DATE	S DATE	TOTALADD	PRN QTY	TOTAL PRICE £	
0.0	21-06-07	27-06-07	<ADD>	0	1.69	
PRN MD.	PEEL MD.	CASSETTE	MULTI	FUNCTION GROUP		
<MANUAL>	<INDIV>	1				

7. When "MANUAL" is set in the Print Mode,

PLU 6 21-JUN-2007(THU) 11:15					TARE kg
 ROAST BEEF					0.000
					WEIGHT kg
					0.422
U/P	F/P	FIX UPR	FIX UPR +WEIGHT	COUPONMS	UNIT PRICE £/kg
SPECIAL	-\$	-%	SP. (U/P)	-\$ (U/P)	4.00
0.00	0.00	0.0	0.00	0.00	
-%(U/P)	P DATE	S DATE	TOTALADD	PRN QTY	TOTAL PRICE £
0.0	21-06-07	27-06-07	<ADD>	0	1.69
PRN MD.	PEEL MD.	CASSETTE	MULTI	FUNCTION GROUP	
<MANUAL>	<INDIV>	1			

Press the [PRINT] key on the key sheet.

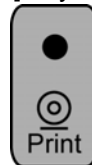

The label is issued.



Non-traceable products



Traceable products

When "AUTO" is set in the Print Mode,

PLU 6 21-JUN-2007(THU) 11:15					TARE kg
 ROAST BEEF					0.000
					WEIGHT kg
					0.422
U/P	F/P	FIX UPR	FIX UPR +WEIGHT	COUPONMS	UNIT PRICE £/kg
SPECIAL	-\$	-%	SP. (U/P)	-\$ (U/P)	4.00
0.00	0.00	0.0	0.00	0.00	
-%(U/P)	P DATE	S DATE	TOTALADD	PRN QTY	TOTAL PRICE £
0.0	21-06-07	27-06-07	<ADD>	0	1.69
PRN MD.	PEEL MD.	CASSETTE	MULTI	FUNCTION GROUP	
<AUTO>	<INDIV>	0			

The label is automatically issued as soon as the weighing is stabilized.



Non-traceable products



Traceable products

2.1.2 WEIGHING FIXED PRICE PRODUCTS

1. Ensure that the initial screen is displayed.

PLU 0 21-JUN-2007(THU) 11:15					TARE kg	0.000
Check the weight before operation. Enter PLU No. and press [PLU] key.					ZERO WEIGHT kg	0.000
PLU No.				PRN MD. <MANUAL>		
0						
RIB STEAK	TOP SIRLOIN WHOLE	ROUND STEAK BONELESS	PORK CHOPS BONELESS	SMOKED SAUSAGE	UNIT PRICE £/kg	0.00
ROAST BEEF	T-BONE STEAK	GROUND BEEF EXTRA	MAINE LOBSTER FRESH	SALMON FILLET GUARANTEE	TOTAL PRICE £	0.00
CASSETTE	HAM SANDWICH	HOT SWEET & SOUR WIN	TILAPIA FILLET SKIN-ON	VOID		
1						

2. Enter a desired PLU number using the numeric keys and press the [PLU] key on the key sheet, or simply press a preset key on the screen where the product is allocated.

EXAMPLE PLU No.6 “Roast Beef”

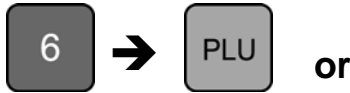

PLU 0 21-JUN-2007(THU) 11:15					TARE kg	0.000
Check the weight before operation. Enter PLU No. and press [PLU] key.					ZERO WEIGHT kg	0.000
No.				PRN MD. <MANUAL>		
0						
RIB STEAK	TOP SIRLOIN WHOLE	ROUND STEAK BONELESS	PORK CHOPS BONELESS	SMOKED SAUSAGE	UNIT PRICE £/kg	0.00
ROAST BEEF	T-BONE STEAK	GROUND BEEF EXTRA	MAINE LOBSTER FRESH	SALMON FILLET GUARANTEE	TOTAL PRICE £	0.00
CASSETTE	HAM SANDWICH	HOT SWEET & SOUR WIN	TILAPIA FILLET SKIN-ON	VOID		
1						

3. When the product is preset as a traceable item, the traceability screen appears. See Chapter 4 for more details about traceability products.

4. The selected PLU screen appears.

Without Preset Tare Weight

PLU 6 21-JUN-2007(THU) 11:15					TARE kg	0.000
ROAST BEEF					ZERO WEIGHT kg	0.000
U/P	F/P	FIX UPR	FIX UPR +WEIGHT	COUPONMS		
0.00	0.00	0.0	0.00	0		
SPECIAL	P DATE	S DATE	TOTALADD	PRN QTY		
0.00	21-06-07	27-06-07	<ADD>	0		
PRN MD.	PEEL MD.	CASSETTE	MULTI	FUNCTION GROUP	FIXED PRICE £	4.00
<MANUAL>	<INDIV>	1	MULTI	FUNCTION GROUP		

With Preset Tare Weight

PLU 6 21-JUN-2007(THU) 11:15					NET	PT	kg
 ROAST BEEF					0.050		
					ZERO	WEIGHT	kg
					-0.050		
U/P	F/P	FIX UPR	FIX UPR +WEIGHT	COUPONMS			
0.00	0.00	0.0	0.00	0			
SPECIAL	-\$	-%	SP. (U/P)	-\$ (U/P)			
0.00	0.00	0.0	0.00	0.00			
-(U/P)	P DATE	S DATE	TOTALADD	PRN QTY			
0.0	21-06-07	27-06-07	<ADD>	0			
PRN MD.	PEEL MD.	CASSETTE	MULTI	FUNCTION GROUP	FIXED PRICE £		
<MANUAL>	<INDIV>	0			4.00		

Manual Tare Entry

To newly enter a tare weight or overwrite an existing tare weight, enter the tare weight using the numeric keys and press the "TARE" field on the screen.

EXAMPLE Tare weight "50g"

PLU 6 21-JUN-2007(THU) 11:15					NET	PT	kg
 ROAST BEEF					0.050		
					ZERO	WEIGHT	kg
					-0.050		
U/P	F/P	FIX UPR	FIX UPR +WEIGHT	COUPONMS			
0.00	0.00	0.0	0.00	0			
SPECIAL	-\$	-%	SP. (U/P)	-\$ (U/P)			
0.00	0.00	0.0	0.00	0.00			
-(U/P)	P DATE	S DATE	TOTALADD	PRN QTY			
0.0	21-06-07	27-06-07	<ADD>	0			
PRN MD.	PEEL MD.	CASSETTE	MULTI	FUNCTION GROUP	FIXED PRICE £		
<MANUAL>	<INDIV>	0			4.00		

5. See Chapter 5 for more details about temporary change operations.

6. Put a product on the weigh platter.

PRODUCT

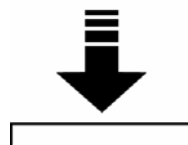

The weight is measured but the fixed price stays the same.

PLU 6 21-JUN-2007(THU) 11:15					TARE	kg
 ROAST BEEF					0.000	
					WEIGHT	kg
					0.422	
U/P	F/P	FIX UPR	FIX UPR +WEIGHT	COUPONMS		
0.00	0.00	0.0	0.00	0		
SPECIAL	-\$	-%	SP. (U/P)	-\$ (U/P)		
0.00	0.00	0.0	0.00	0.00		
-(U/P)	P DATE	S DATE	TOTALADD	PRN QTY		
0.0	21-06-07	27-06-07	<ADD>	0		
PRN MD.	PEEL MD.	CASSETTE	MULTI	FUNCTION GROUP	FIXED PRICE £	
<MANUAL>	<INDIV>	0			4.00	

7. When "MANUAL" is set in the Print Mode,

PLU 6					21-JUN-2007(THU) 11:15		TARE kg	
ROAST BEEF					0.000		WEIGHT kg	
					0.422		FIXED PRICE £	
U/P	F/P	FIX UPR	FIX UPR +WEIGHT	COUPONMS	0			
SPECIAL	-\$	-%	SP. (U/P)	-\$ (U/P)	0.00			
0.00	0.00	0.0	0.00	0.00	0.00			
-%(U/P)	P DATE	S DATE	TOTALADD	PRN QTY	0			
0.0	21-06-07	27-06-07	<ADD>	0	4.00			
PRN MD.	PEEL MD.	CASSETTE	MULTI	FUNCTION GROUP	0			
<MANUAL>	<INDIV>	0						

Press the [PRINT] key on the key sheet.

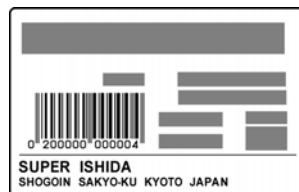

Non-traceable products

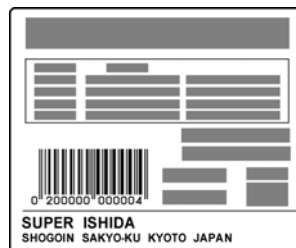

Traceable products

When "AUTO" is set in the Print Mode,

PLU 6					21-JUN-2007(THU) 11:15		TARE kg	
ROAST BEEF					0.000		WEIGHT kg	
					0.422		FIXED PRICE £	
U/P	F/P	FIX UPR	FIX UPR +WEIGHT	COUPONMS	0			
SPECIAL	-\$	-%	SP. (U/P)	-\$ (U/P)	0.00			
0.00	0.00	0.0	0.00	0.00	0.00			
-%(U/P)	P DATE	S DATE	TOTALADD	PRN QTY	0			
0.0	21-06-07	27-06-07	<ADD>	0	4.00			
PRN MD.	PEEL MD.	CASSETTE	MULTI	FUNCTION GROUP	0			
<AUTO>	<INDIV>	0						

The label is automatically issued as soon as the weighing is stabilized.



Non-traceable products

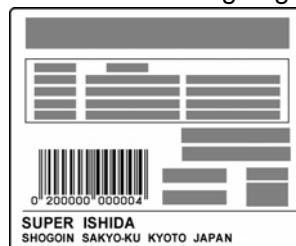

Traceable products

2.1.3 PROCESSING FIXED PRICE PRODUCTS

1. Ensure that the initial screen is displayed.

PLU 0					21-JUN-2007(THU) 11:15					TARE	kg	0.000	
Check the weight before operation. Enter PLU No. and press [PLU] key.										ZERO	WEIGHT	kg	0.000
PLU No.				PRN MD.									
0				<MANUAL>									
RIB STEAK	TOP SIRLOIN WHOLE	ROUND STEAK BONELESS	PORK CHOPS BONELESS	SMOKED SAUSAGE	UNIT PRICE £/kg								
ROAST BEEF	T-BONE STEAK	GROUND BEEF EXTRA	MAINE LOBSTER FRESH	SALMON FILLET GUARANTEE	0.00								
CASSETTE	HAM SANDWICH	HOT SWEET & SOUR WIN	TILAPIA FILLET SKIN-ON	VOID	TOTAL PRICE £								
1					0.00								

2. Enter a desired PLU number using the numeric keys and press the [PLU] key on the key sheet, or simply press a preset key on the screen where the product is allocated.

EXAMPLE PLU No.6 "Roast Beef"



PLU 0					21-JUN-2007(THU) 11:15					TARE	kg	0.000	
Check the weight before operation. Enter PLU No. and press [PLU] key.										ZERO	WEIGHT	kg	0.000
No.				PRN MD.									
<MANUAL>				<MANUAL>									
RIB STEAK	TOP SIRLOIN WHOLE	ROUND STEAK BONELESS	PORK CHOPS BONELESS	SMOKED SAUSAGE	UNIT PRICE £/kg								
ROAST BEEF	T-BONE STEAK	GROUND BEEF EXTRA	MAINE LOBSTER FRESH	SALMON FILLET GUARANTEE	0.00								
CASSETTE	HAM SANDWICH	HOT SWEET & SOUR WIN	TILAPIA FILLET SKIN-ON	VOID	TOTAL PRICE £								
1					0.00								

3. When the product is preset as a traceable item, the traceability screen appears. See Chapter 4 for more details about traceability products.

4. The selected PLU screen appears.

PLU 6					21-JUN-2007(THU) 11:15					PCS	1
ROAST BEEF										FIXED WEIGHT	kg
U/P	F/P	FIX UPR	FIX UPR +WEIGHT	COUPONMS							
0.00	0.00	0.0	0.00	0							
SPECIAL	-\$	-%	SP. (U/P)	-\$ (U/P)							
0.00	0.00	0.0	0.00	0.00							
-(U/P)	P DATE	S DATE	TOTALADD	PRN QTY	FIXED PRICE £						
0.0	21-06-07	27-06-07	<ADD>	0	4.00						
PRN MD.	PEEL MD.	CASSETTE	MULTI	FUNCTION GROUP							
<MANUAL>	<INDIV>	1									

5. See Chapter 5 for more details about temporary change operations.

- 6.** Press the [PRINT] key on the key sheet to issue the labels.



The label is issued.

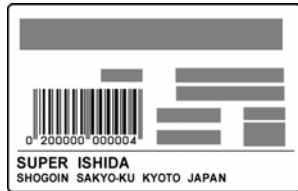

Non-traceable products

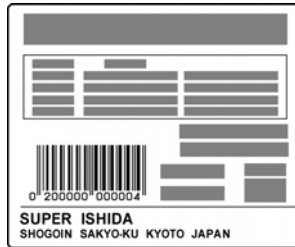

Traceable products

Remove the label.

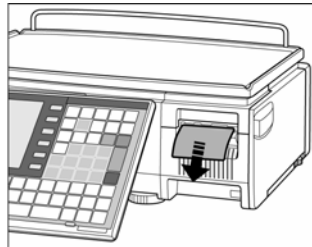

The next label is issued.



Non-traceable products

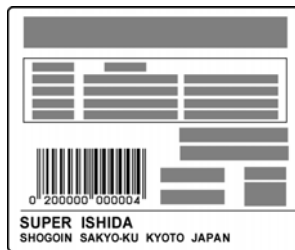

Traceable products

Note: To stop printing, press the [PRINT] key again.

2.1.4 PROCESSING FIXED WEIGHT/FIXED UNIT PRICE PRODUCTS

1. Ensure that the initial screen is displayed.

PLU 0					21-JUN-2007(THU) 11:15					TARE kg	
Check the weight before operation. Enter PLU No. and press [PLU] key.										0.000	
PLU No.					PRN MD.					ZERO WEIGHT kg	
0					<MANUAL>					0.000	
RIB STEAK		TOP SIRLOIN WHOLE		ROUND STEAK BONELESS		PORK CHOPS BONELESS		SMOKED SAUSAGE		UNIT PRICE £/kg	
ROAST BEEF		T-BONE STEAK		GROUND BEEF EXTRA		MAINE LOBSTER FRESH		SALMON FILLET GUARANTE		0.00	
CASSETTE					VOID					TOTAL PRICE £	
1										0.00	

2. Enter a desired PLU number using the numeric keys and press the [PLU] key on the key sheet, or simply press a preset key on the screen where the product is allocated.

EXAMPLE PLU No.6 "Roast Beef"



PLU 0					21-JUN-2007(THU) 11:15					TARE kg	
Check the weight before operation. Enter PLU No. and press [PLU] key.										0.000	
No.					PRN MD.					ZERO WEIGHT kg	
6					<MANUAL>					0.000	
RIB STEAK		TOP SIRLOIN WHOLE		ROUND STEAK BONELESS		PORK CHOPS BONELESS		SMOKED SAUSAGE		UNIT PRICE £/kg	
ROAST BEEF		T-BONE STEAK		GROUND BEEF EXTRA		MAINE LOBSTER FRESH		SALMON FILLET GUARANTE		0.00	
CASSETTE					VOID					TOTAL PRICE £	
1										0.00	

3. When the product is preset as a traceable item, the traceability screen appears. See Chapter 4 for more details about traceability products.
4. The selected PLU screen appears.

PLU 6					21-JUN-2007(THU) 11:15					FIXED WEIGHT kg	
ROAST BEEF											
U/P		F/P		FIX UPR		FIX UPR +WEIGHT		COUPONMS		FIXED U.PRI £/kg	
SPECIAL		-\$		-%		SP. (U/P)		-\$(U/P)		4.00	
0.00		0.00		0.0		0.00		0.00			
-%(U/P)		P DATE		S DATE		TOTALADD		PRN QTY		TOTAL PRICE £	
0.0		21-06-07		27-06-07		<ADD>		0		0.00	
PRN MD.		PEEL MD.		CASSETTE		MULTI		FUNCTION GROUP			
<MANUAL>		<INDIV>		1							

5. See Chapter 5 for more details about temporary change operations.

6. Enter the fixed weight using the numeric keys on the key sheet and press the “FIXED WEIGHT” field.

EXAMPLE Fixed weight “858g”



PLU 6					21-JUN-2007(THU) 11:15																																							
ROAST BEEF					FIXED WEIGHT kg																																							
					0.858																																							
<table border="1"> <tr> <th>U/P</th> <th>F/P</th> <th>FIX UPR</th> <th>FIX UPR +WEIGHT</th> <th>COUPONMS</th> </tr> <tr> <td>SPECIAL</td> <td>-\$</td> <td>-%</td> <td>SP. (U/P)</td> <td>-\$ (U/P)</td> </tr> <tr> <td>0.00</td> <td>0.00</td> <td>0.0</td> <td>0.00</td> <td>0.00</td> </tr> <tr> <th>-(U/P)</th> <th>P DATE</th> <th>S DATE</th> <th>TOTALADD</th> <th>PRN QTY</th> </tr> <tr> <td>0.0</td> <td>21-06-07</td> <td>27-06-07</td> <td><ADD></td> <td>0</td> </tr> <tr> <th>PRN MD.</th> <th>PEEL MD.</th> <th>CASSETTE</th> <th>MULTI</th> <th>FUNCTION GROUP</th> </tr> <tr> <td><MANUAL></td> <td><INDIV></td> <td>1</td> <td></td> <td></td> </tr> </table>					U/P	F/P	FIX UPR	FIX UPR +WEIGHT	COUPONMS	SPECIAL	-\$	-%	SP. (U/P)	-\$ (U/P)	0.00	0.00	0.0	0.00	0.00	-(U/P)	P DATE	S DATE	TOTALADD	PRN QTY	0.0	21-06-07	27-06-07	<ADD>	0	PRN MD.	PEEL MD.	CASSETTE	MULTI	FUNCTION GROUP	<MANUAL>	<INDIV>	1			FIXED U.PRI £/kg				
					U/P	F/P	FIX UPR	FIX UPR +WEIGHT	COUPONMS																																			
SPECIAL	-\$	-%	SP. (U/P)	-\$ (U/P)																																								
0.00	0.00	0.0	0.00	0.00																																								
-(U/P)	P DATE	S DATE	TOTALADD	PRN QTY																																								
0.0	21-06-07	27-06-07	<ADD>	0																																								
PRN MD.	PEEL MD.	CASSETTE	MULTI	FUNCTION GROUP																																								
<MANUAL>	<INDIV>	1																																										
					4.00																																							
					TOTAL PRICE £																																							
					3.43																																							

7. Press the [PRINT] key on the key sheet to issue the labels.



The label is issued.



Non-traceable products

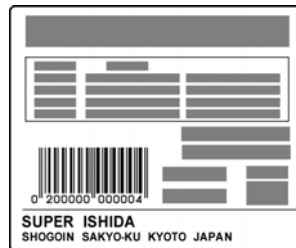

Traceable products

Remove the label.

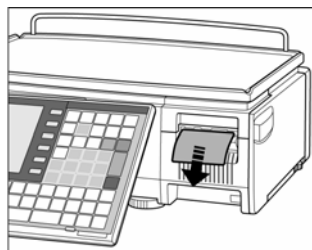

The next label is issued.



Non-traceable products

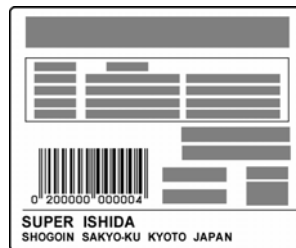

Traceable products

Note: To stop printing, press the [PRINT] key again.

2.2 LABEL ISSUE WITH OPERATORS

2.2.1 WEIGHING UNIT PRICE PRODUCTS

1. Ensure that the initial screen is displayed.

PLU 0					21-JUN-2007(THU) 11:15					TARE kg		
 Check the weight before operation. Enter PLU No. and press [PLU] key.					0.000		ZERO WEIGHT kg		0.000		UNIT PRICE £/kg	
					0.000		0.00		TOTAL PRICE £		0.00	
PLU No.				PRN MD.								
0				<MANUAL>								
RIB STEAK	TOP SIRLOIN WHOLE	ROUND STEAK BONELESS	PORK CHOPS BONELESS	SMOKED SAUSAGE								
ROAST BEEF	T-BONE STEAK	GROUND BEEF EXTRA	MAINE LOBSTER FRESH	SALMON FILLET GUARANTEE								
CASSETTE	HAM SANDWICH	HOT SWEET & SOUR WIN	TILAPIA FILLET SKIN-ON	VOID								
1												

2. Enter a desired PLU number using the numeric keys and press the [PLU] key on the key sheet, or simply press a preset key on the screen where the product is allocated.

EXAMPLE PLU No.6 "Roast Beef"



PLU 0					21-JUN-2007(THU) 11:15					TARE kg		
 Check the weight before operation. Enter PLU No. and press [PLU] key.					0.000		ZERO WEIGHT kg		0.000		UNIT PRICE £/kg	
					0.000		0.00		TOTAL PRICE £		0.00	
No.				PRN MD.								
6				<MANUAL>								
JACK	TOP SIRLOIN WHOLE	ROUND STEAK BONELESS	PORK CHOPS BONELESS	SMOKED SAUSAGE								
ROAST BEEF	T-BONE STEAK	GROUND BEEF EXTRA	MAINE LOBSTER FRESH	SALMON FILLET GUARANTEE								
CASSETTE	HAM SANDWICH	HOT SWEET & SOUR WIN	TILAPIA FILLET SKIN-ON	VOID								
1												

3. When the product is preset as a traceable item, the traceability screen appears. See Chapter 4 for more details about traceability products.

4. The selected product screen appears.

Without Preset Tare Weight

PLU 6					21-JUN-2007(THU) 11:15					TARE kg		
 ROAST BEEF					0.000		ZERO WEIGHT kg		0.000		UNIT PRICE £/kg	
					0.000		4.00		TOTAL PRICE £		0.00	
JACK	BETTY	JONE	ERIC	JODY								
U/P	F/P	FIX UPR	FIX UPR +WEIGHT	SUBTOTAL DISPLAY								
SPECIAL	-£	-%	SP. (U/P)	-£(U/P)								
0.00	0.00	0.0	0.00	0.00								
-%(U/P)	TOTAL DISPLAY	VOID	TARE	OPERATOR GROUP								
0.0												

With Preset Tare Weight

PLU 6					21-JUN-2007(THU) 11:15			NET	PT	kg
 ROAST BEEF					0.050			ZERO	WEIGHT	kg
					-0.050			UNIT PRICE £/kg		
JACK	BETTY	JONE	ERIC	JODY	TOTAL PRICE £			0.00		
U/P	F/P	FIX UPR	FIX UPR +WEIGHT	SUBTOTAL DISPLAY	0.00			0.00		
SPECIAL	-£	-%	SP. (U/P)	-£(U/P)	0.00			0.00		
0.00	0.00	0.0	0.00	0.00	TOTAL PRICE £			0.00		
-%(U/P)	TOTAL DISPLAY	VOID	TARE	OPERATOR GROUP	0.0			0.00		
0.0										

Manual Tare Entry

To newly enter a tare weight or overwrite an existing tare weight, enter the tare weight using the numeric keys and press the "TARE" field on the screen.

EXAMPLE Tare weight "50g"

5

0

PLU 6					21-JUN-2007(THU) 11:15			NET	PT	kg
 ROAST BEEF					0.050			ZERO	WEIGHT	kg
					-0.050			UNIT PRICE £/kg		
JACK	BETTY	JONE	ERIC	JODY	TOTAL PRICE £			0.00		
U/P	F/P	FIX UPR	FIX UPR +WEIGHT	SUBTOTAL DISPLAY	0.00			0.00		
SPECIAL	-£	-%	SP. (U/P)	-£(U/P)	0.00			0.00		
0.00	0.00	0.0	0.00	0.00	TOTAL PRICE £			0.00		
-%(U/P)	TOTAL DISPLAY	VOID	TARE	OPERATOR GROUP	0.0			0.00		
0.0										

5. See Chapter 5 for more details about temporary change operations.
6. Put a product on the weigh platter.



The weight is measured and the total price is calculated.

PLU 6					21-JUN-2007(THU) 11:15			TARE	kg	
 ROAST BEEF					0.000			WEIGHT	kg	
					0.422			UNIT PRICE £/kg		
JACK	BETTY	JONE	ERIC	JODY	TOTAL PRICE £			1.69		
U/P	F/P	FIX UPR	FIX UPR +WEIGHT	SUBTOTAL DISPLAY	0.00			0.00		
SPECIAL	-£	-%	SP. (U/P)	-£(U/P)	0.00			0.00		
0.00	0.00	0.0	0.00	0.00	TOTAL PRICE £			1.69		
-%(U/P)	TOTAL DISPLAY	VOID	TARE	OPERATOR GROUP	0.0			0.00		
0.0										

7. Press a operator button on the screen to issue the label.

EXAMPLE Operator "BETTY"

PLU 6		21-JUN-2007(THU) 11:15			TARE kg
ROAST BEEF					0.000
					WEIGHT kg
					0.422
JACK	BETTY	JONE	ERIC	JODY	UNIT PRICE £/kg
U/P		FIX UPR	FIX UPR +WEIGHT	SUBTOTAL DISPLAY	4.00
SPECIAL		-%	SP. (U/P)	-%(U/P)	TOTAL PRICE £
0.00	0	0.0	0.00	0.00	1.69
-%(U/P)	TOTAL DISPLAY	VOID	TARE	OPERATOR GROUP	
0.0					

The label is issued.



2.2.2 WEIGHING FIXED PRICE PRODUCTS

1. Ensure that the initial screen is displayed.

PLU 0 21-JUN-2007(THU) 11:15					TARE kg	0.000
					Check the weight before operation. Enter PLU No. and press [PLU] key.	
PLU No.				PRN MD.	ZERO WEIGHT kg	0.000
0				<MANUAL>	UNIT PRICE £/kg	0.00
RIB STEAK	TOP SIRLOIN WHOLE	ROUND STEAK BONELESS	PORK CHOPS BONELESS	SMOKED SAUSAGE	TOTAL PRICE £	0.00
ROAST BEEF	T-BONE STEAK	GROUND BEEF EXTRA	MAINE LOBSTER FRESH	SALMON FILLET GUARANTEE		
CASSETTE	HAM SANDWICH	HOT SWEET & SOUR WIN	TILAPIA FILLET SKIN-ON	VOID		
1						

2. Enter a desired PLU number using the numeric keys and press the [PLU] key on the key sheet, or simply press a preset key on the screen where the product is allocated.

EXAMPLE PLU No.6 "Roast Beef"



PLU 0 21-JUN-2007(THU) 11:15					TARE kg	0.000
					Check the weight before operation. Enter PLU No. and press [PLU] key.	
No.				PRN MD.	ZERO WEIGHT kg	0.000
<MANUAL>				<MANUAL>	UNIT PRICE £/kg	0.00
ROAST BEEF	T-BONE STEAK	GROUND BEEF EXTRA	MAINE LOBSTER FRESH	SALMON FILLET GUARANTEE	TOTAL PRICE £	0.00
CASSETTE	HAM SANDWICH	HOT SWEET & SOUR WIN	TILAPIA FILLET SKIN-ON	VOID		
1						

3. When the product is preset as a traceable item, the traceability screen appears. See Chapter 4 for more details about traceability products.
4. The selected product screen appears.

Without Preset Tare Weight

PLU 6 21-JUN-2007(THU) 11:15					TARE kg	0.000
ROAST BEEF					ZERO WEIGHT kg	0.000
JACK	BETTY	JONE	ERIC	JODY		
U/P	F/P	FIX UPR	FIX UPR +WEIGHT	SUBTOTAL DISPLAY		
SPECIAL	-£	-%	SP. (U/P)	-£(U/P)		
0.00	0.00	0.0	0.00	0.00	FIXED PRICE £	4.00
-%(U/P)	TOTAL DISPLAY	VOID	TARE	OPERATOR GROUP		
0.0						

With Preset Tare Weight

PLU 6 21-JUN-2007(THU) 11:15					NET	PT	kg
ROAST BEEF					0.050		
					ZERO	WEIGHT	kg
					-0.050		
JACK	BETTY	JONE	ERIC	JODY			
U/P	F/P	FIX UPR	FIX UPR +WEIGHT	SUBTOTAL DISPLAY			
SPECIAL	-£	-%	SP. (U/P)	-£(U/P)			
0.00	0.00	0.0	0.00	0.00	FIXED PRICE £		
-%(U/P)	TOTAL DISPLAY	VOID	TARE	OPERATOR GROUP	4.00		
0.0							

Manual Tare Entry

To newly enter a tare weight or overwrite an existing tare weight, enter the tare weight using the numeric keys and press the "TARE" field on the screen.

EXAMPLE Tare weight "50g"

PLU 6 21-JUN-2007(THU) 11:15					NET	PT	kg
ROAST BEEF					0.050		
					ZERO	WEIGHT	kg
					-0.050		
JACK	BETTY	JONE	ERIC	JODY			
U/P	F/P	FIX UPR	FIX UPR +WEIGHT	SUBTOTAL DISPLAY			
SPECIAL	-£	-%	SP. (U/P)	-£(U/P)			
0.00	0.00	0.0	0.00	0.00	FIXED PRICE £		
-%(U/P)	TOTAL DISPLAY	VOID	TARE	OPERATOR GROUP	4.00		
0.0							

5. See Chapter 5 for more details about temporary change operations.

6. Put a product on the weigh platter.

PRODUCT

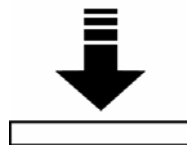

The weight is measured and the total price is calculated.

PLU 6 21-JUN-2007(THU) 11:16					TARE	kg
ROAST BEEF					0.000	
					WEIGHT	kg
					0.422	
JACK	BETTY	JONE	ERIC	JODY		
U/P	F/P	FIX UPR	FIX UPR +WEIGHT	SUBTOTAL DISPLAY		
SPECIAL	-£	-%	SP. (U/P)	-£(U/P)		
0.00	0.00	0.0	0.00	0.00	FIXED PRICE £	
-%(U/P)	TOTAL DISPLAY	VOID	TARE	OPERATOR GROUP	4.00	
0.0						

7. Press a operator button on the screen to issue the label.

EXAMPLE Operator "BETTY"

PLU 6		21-JUN-2007(THU) 11:16			TARE kg
ROAST BEEF					0.000
					WEIGHT kg
					0.422
JACK	BETTY	JONE	ERIC	JODY	
U/P		FIX UPR	FIX UPR +WEIGHT	SUBTOTAL DISPLAY	
SPECIAL		-%	SP. (U/P)	-£(U/P)	
0.00	0	0.0	0.00	0.00	FIXED PRICE £
-%(U/P)	TOTAL DISPLAY	VOID	TARE	OPERATOR GROUP	4.00
0.0					

The label is issued.

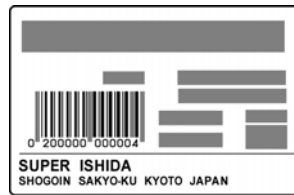

2.2.3 PROCESSING FIXED PRICE PRODUCTS

1. Ensure that the initial screen is displayed.

PLU 0					21-JUN-2007(THU) 11:15					TARE	kg	0.000	
Check the weight before operation. Enter PLU No. and press [PLU] key.										ZERO	WEIGHT	kg	0.000
PLU No.					PRN MD.								
0					<MANUAL>								
RIB STEAK	TOP SIRLOIN WHOLE	ROUND STEAK BONELESS	PORK CHOPS BONELESS	SMOKED SAUSAGE		UNIT PRICE £/kg							
						0.00							
ROAST BEEF	T-BONE STEAK	GROUND BEEF EXTRA	MAINE LOBSTER FRESH	SALMON FILLET GUARANTEE		TOTAL PRICE £							
						0.00							
CASSETTE	HAM SANDWICH	HOT SWEET & SOUR WIN	TILAPIA FILLET SKIN-ON	VOID									
1													

2. Enter a desired PLU number using the numeric keys and press the [PLU] key on the key sheet, or simply press a preset key on the screen where the product is allocated.

EXAMPLE PLU No.6 "Roast Beef"



PLU 0					21-JUN-2007(THU) 11:15					TARE	kg	0.000	
Check the weight before operation. Enter PLU No. and press [PLU] key.										ZERO	WEIGHT	kg	0.000
No.					PRN MD.								
0					<MANUAL>								
RIB STEAK	TOP SIRLOIN WHOLE	ROUND STEAK BONELESS	PORK CHOPS BONELESS	SMOKED SAUSAGE		UNIT PRICE £/kg							
						0.00							
ROAST BEEF	T-BONE STEAK	GROUND BEEF EXTRA	MAINE LOBSTER FRESH	SALMON FILLET GUARANTEE		TOTAL PRICE £							
						0.00							
CASSETTE	HAM SANDWICH	HOT SWEET & SOUR WIN	TILAPIA FILLET SKIN-ON	VOID									
1													

3. When the product is preset as a traceable item, the traceability screen appears. See Chapter 4 for more details about traceability products.

4. The selected PLU screen appears.

PLU 6					21-JUN-2007(THU) 11:15					PCS	1
ROAST BEEF										FIXED WEIGHT	kg
JACK	BETTY	JONE	ERIC	JODY							
U/P	F/P	FIX UPR	FIX UPR +WEIGHT	SUBTOTAL DISPLAY							
SPECIAL	-£	-%	SP. (U/P)	-£(U/P)	FIXED PRICE £						
0.00	0.00	0.0	0.00	0.00	4.00						
-%(U/P)	TOTAL DISPLAY	VOID	TARE	OPERATOR GROUP							
0.0											

5. See Chapter 5 for more details about temporary change operations.

6. Press a operator button on the screen to issue the label.

EXAMPLE Operator "BETTY"

PLU 6		21-JUN-2007(THU) 11:15			PCS	1
ROAST BEEF					FIXED WEIGHT	kg
JACK	BETTY	JONE	ERIC	JODY		
U/P		FIX UPR	FIX UPR +WEIGHT	SUBTOTAL DISPLAY		
SPECIAL		-%	SP. (U/P)	-£(U/P)	FIXED PRICE	£
0.00	0	0.0	0.00	0.00	4.00	
-(U/P)	TOTAL DISPLAY	VOID	TARE	OPERATOR GROUP		
0.0						

The label is issued.

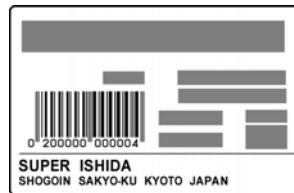

2.2.4 PROCESSING FIXED WEIGHT/FIXED UNIT PRICE PRODUCTS

1. Ensure that the initial screen is displayed.

PLU 0					21-JUN-2007(THU) 11:15					TARE	kg
Check the weight before operation. Enter PLU No. and press [PLU] key.										0.000	
PLU No.										ZERO	WEIGHT kg
0										0.000	
PRN MD.										UNIT PRICE £/kg	
<MANUAL>										0.00	
RIB STEAK	TOP SIRLOIN WHOLE	ROUND STEAK BONELESS	PORK CHOPS BONELESS	SMOKED SAUSAGE							
ROAST BEEF	T-BONE STEAK	GROUND BEEF EXTRA	MAINE LOBSTER FRESH	SALMON FILLET GUARANTEE							
CASSETTE	HAM SANDWICH	HOT SWEET & SOUR WIN	TILAPIA FILLET SKIN-ON	VOID							
1										TOTAL PRICE £	
										0.00	

2. Enter a desired PLU number using the numeric keys and press the [PLU] key on the key sheet, or simply press a preset key on the screen where the product is allocated.

EXAMPLE PLU No.6 "Roast Beef"



PLU 0					21-JUN-2007(THU) 11:15					TARE	kg
Check the weight before operation. Enter PLU No. and press [PLU] key.										0.000	
PLU No.										ZERO	WEIGHT kg
0										0.000	
PRN MD.										UNIT PRICE £/kg	
<MANUAL>										0.00	
RIB STEAK	TOP SIRLOIN WHOLE	ROUND STEAK BONELESS	PORK CHOPS BONELESS	SMOKED SAUSAGE							
ROAST BEEF	T-BONE STEAK	GROUND BEEF EXTRA	MAINE LOBSTER FRESH	SALMON FILLET GUARANTEE							
CASSETTE	HAM SANDWICH	HOT SWEET & SOUR WIN	TILAPIA FILLET SKIN-ON	VOID							
1										TOTAL PRICE £	
										0.00	

3. When the product is preset as a traceable item, the traceability screen appears. See Chapter 4 for more details about traceability products.

4. The selected PLU screen appears.

PLU 6					21-JUN-2007(THU) 11:15						
ROAST BEEF										FIXED WEIGHT kg	
JACK	BETTY	JONE	ERIC	JODY							
U/P	F/P	FIX UPR	FIX UPR +WEIGHT	SUBTOTAL DISPLAY							
										4.00	
SPECIAL	-£	-%	SP. (U/P)	-£(U/P)							
0.00	0.00	0.0	0.00	0.00							
-%(U/P)	TOTAL DISPLAY	VOID	TARE	OPERATOR GROUP							
0.0											
										TOTAL PRICE £	
										0.00	

5. See Chapter 5 for more details about temporary change operations.

6. Enter the fixed weight using the numeric keys on the key sheet and press the “FIXED WEIGHT” field.

EXAMPLE Fixed weight “858g”



PLU 6					21-JUN-2007(THU) 11:15				
ROAST BEEF					WEIGHT kg				
					0.858				
JACK	BETTY	JONE	ERIC	JODY	FIXED U.PRI £/kg				
U/P	F/P	FIX UPR	FIX UPR +WEIGHT	SUBTOTAL DISPLAY	4.00				
SPECIAL	-£	-%	SP. (U/P)	-£(U/P)	TOTAL PRICE £				
0.00	0.00	0.0	0.00	0.00	3.43				
-%(U/P)	TOTAL DISPLAY	VOID	TARE	OPERATOR GROUP					
0.0									

7. Press a operator button on the screen to issue the label.

EXAMPLE Operator “BETTY”

PLU 6					21-JUN-2007(THU) 11:15				
ROAST BEEF					FIXED WEIGHT kg				
					0.858				
JACK	BETTY	JONE	ERIC	JODY	FIXED U.PRI £/kg				
U/P	F/P	FIX UPR	FIX UPR +WEIGHT	SUBTOTAL DISPLAY	4.00				
SPECIAL	-£	-%	SP. (U/P)	-£(U/P)	TOTAL PRICE £				
0.00	0.00	0.0	0.00	0.00	3.43				
-%(U/P)	TOTAL DISPLAY	VOID	TARE	OPERATOR GROUP					
0.0									

The label is issued.



RECEIPT ISSUE

3.1 SALES BY THE SAME OPERATOR

1. Ensure that the initial screen is displayed.

PLU 0		21-JUN-2007(THU) 11:20		TARE	kg	0.000
Check the weight before operation. Enter PLU No. and press [PLU] key.				ZERO	WEIGHT	kg
PLU No.	0					0.000
TOTAL DISPLAY				UNIT PRICE	£/kg	0.00
CSIS						
KEY LOCK	<ON>			TOTAL PRICE	£	0.00

- 2-1 Select a desired product category by pressing the corresponding field on the screen.

EXAMPLE Select "Meat" category.

PLU 0		21-JUN-2007(THU) 11:20		TARE	kg	0.000
Check the weight before operation. Enter PLU No. and press [PLU] key.				ZERO	WEIGHT	kg
PLU No.	0					0.000
TOTAL DISPLAY				UNIT PRICE	£/kg	0.00
CSIS						
KEY LOCK	<ON>			TOTAL PRICE	£	0.00

- 2-2 The PLU preset screen for the selected category appears. Then, enter a desired PLU number using the numeric keys and press the [PLU] key on the key sheet, or simply press a preset key on the screen where a desired product is allocated.

EXAMPLE Select PLU No.1 "Rib Steak".



PLU 0		21-JUN-2007(THU) 11:20		TARE	kg	0.000
Check the weight before operation. Enter PLU No. and press [PLU] key.				ZERO	WEIGHT	kg
RIB STEAK	TOP SIRLOIN WHOLE	ROUND STEAK BONELESS	PORK CHOPS BONELESS	SMOKED SAUSAGE		0.000
				UNIT PRICE	£/kg	0.00
				TOTAL PRICE	£	0.00
						

2-3 The PLU screen appears.

Weighing Unit Price PLU					
PLU 1 21-JUN-2007(THU) 11:20					
RIB STEAK					NET PT kg
					0.050
					ZERO WEIGHT kg
					-0.050
OPE 001	OPE 002	OPE 003	OPE 004	OPE 005	UNIT PRICE £/kg
OPE 006	OPE 007	OPE 008	OPE 009	OPE 010	3.98
OPE 011	OPE 012	OPE 013	OPE 014	OPE 015	TOTAL PRICE £
TARE	TARE	TARE	TARE	OPERATOR GROUP	0.00

2-4 Put a product on the weigh platter.



PLU 1 21-JUN-2007(THU) 11:20					
RIB STEAK					NET PT kg
					0.050
					WEIGHT kg
					0.362
OPE 001	OPE 002	OPE 003	OPE 004	OPE 005	UNIT PRICE £/kg
OPE 006	OPE 007	OPE 008	OPE 009	OPE 010	3.98
OPE 011	OPE 012	OPE 013	OPE 014	OPE 015	TOTAL PRICE £
TARE	TARE	TARE	TARE	OPERATOR GROUP	1.44

2-5 Press a button on the screen for the operator who has sold the product.

EXAMPLE Select "Operator 002".





PLU 1 21-JUN-2007(THU) 11:20					
RIB STEAK					NET PT kg
					0.050
					WEIGHT kg
					0.362
OPE 001	OPE 002	OPE 003	OPE 004	OPE 005	UNIT PRICE £/kg
OPE 006	OPE 007	OPE 008	OPE 009	OPE 010	3.98
OPE 011	OPE 012	OPE 013	OPE 014	OPE 015	TOTAL PRICE £
TARE	TARE	TARE	TARE	OPERATOR GROUP	1.44

2-6 The subtotal for the selected operator is shown on the screen.

PLU 1		21-JUN-2007(THU) 11:20		OP 2
RIB STEAK				ITEMS
				1 PC(S)
PLU No.			TOTAL	
1			£1.51	
TOTAL DISPLAY			SUBTOTAL £1.44	
			VAT EXCL. £0.07	
KEY LOCK			VAT INCL. (£0.00)	
<ON>			ADDED PRICE £	
			1.44	

3-1 Select a desired product category by pressing the corresponding field on the screen.

EXAMPLE Select "Fish" category.

PLU 1		21-JUN-2007(THU) 11:20		OP 2
RIB STEAK				ITEMS
				1 PC(S)
PLU No.			TOTAL	
1			£1.51	
TOTAL DISPLAY			SUBTOTAL £1.44	
			VAT EXCL. £0.07	
KEY LOCK			VAT INCL. (£0.00)	
<ON>			ADDED PRICE £	
			1.44	

3-2 The PLU preset screen for the selected category appears. Then, enter a desired PLU number using the numeric keys and press the [PLU] key on the key sheet, or simply press a preset key on the screen where a desired product is allocated.

EXAMPLE Select PLU No.102 "Maine Lobster".

or

PLU 1		21-JUN-2007(THU) 11:20		OP 2
RIB STEAK				ITEMS
				1 PC(S)
SALMON FILLET GUARANTE	MAINE LOBSTER FRESH	LAKE TROUT TRUCHAS	SHARK TIBURON	TOTAL
				£1.51
				SUBTOTAL £1.44
				VAT EXCL. £0.07
				VAT INCL. (£0.00)
				ADDED PRICE £
				1.44

3-3 The PLU screen appears.

Fixed Price PLU

PLU 102					21-JUN-2007(THU) 11:20		PCS	1
					FIXED WEIGHT		kg	
OPE 001	OPE 002	OPE 003	OPE 004	OPE 005				
OPE 006	OPE 007	OPE 008	OPE 009	OPE 010				
OPE 011	OPE 012	OPE 013	OPE 014	OPE 015	FIXED PRICE		£	
TARE	TARE	TARE	TARE	OPERATOR GROUP				4.50

3-4 Press a button on the screen for the operator who has sold the product.

EXAMPLE Select "Operator 002".

PLU 102					21-JUN-2007(THU) 11:20		PCS	1
					FIXED WEIGHT		kg	
OPE 001	OPE 002	OPE 003	OPE 004	OPE 005				
OPE 006	OPE 007	OPE 008	OPE 009	OPE 010				
OPE 011	OPE 012	OPE 013	OPE 014	OPE 015	FIXED PRICE		£	
TARE	TARE	TARE	TARE	OPERATOR GROUP				4.50

3-5 The subtotal for the selected operator is shown on the screen.

PLU 102					21-JUN-2007(THU) 11:20		OP 2	
					ITEMS		2PC(S)	
					TOTAL		£6.23	
PLU No.					SUBTOTAL		£5.94	
102					VAT EXCL.		£0.29	
TOTAL DISPLAY					VAT INCL.		(£0.00)	
					ADDED PRICE		£	
KEY LOCK							4.50	
<ON>								

4-1 Select a desired product category by pressing the corresponding field on the screen.

EXAMPLE Select "Bakery" category.

PLU 102					21-JUN-2007(THU) 11:20		OP 2	
					ITEMS		2PC(S)	
					TOTAL		£6.23	
PLU No.					SUBTOTAL		£5.94	
102					VAT EXCL.		£0.29	
TOTAL DISPLAY					VAT INCL.		(£0.00)	
					ADDED PRICE		£	
KEY LOCK							4.50	
<ON>								

- 4-2** The PLU preset screen for the selected category appears. Then, enter a desired PLU number using the numeric keys and press the [PLU] key on the key sheet, or simply press a preset key on the screen where a desired product is allocated.

EXAMPLE Select PLU No.201 “Live Wild Cherry Clam”.



PLU 102					21-JUN-2007(THU) 11:20		OP 2	
					ITEMS		2PC(S)	
					TOTAL		£6.23	
LIVE WILD CHERRYST CLAM(USA)	HAM SANDWICH	BREAKFAST SANDWICH	MEXICAN 7 LAYER DIP	HOT BARBEQUE SPARE RI	SUBTOTAL		£5.94	
					VAT EXCL.		£0.29	
					VAT INCL.		(£0.00)	
					ADDED PRICE		£	
							4.50	

- 4-3** The PLU screen appears.

Weighing Fixed Price PLU

PLU 201					21-JUN-2007(THU) 11:21		TARE kg	
					0.000		ZERO WEIGHT kg	
					0.000			
OPE 001	OPE 002	OPE 003	OPE 004	OPE 005	FIXED PRICE		£	
OPE 006	OPE 007	OPE 008	OPE 009	OPE 010	1.78			
OPE 011	OPE 012	OPE 013	OPE 014	OPE 015				
TARE	TARE	TARE	TARE	OPERATOR GROUP				

- 4-4** Put a product on the weigh platter.



PLU 201					21-JUN-2007(THU) 11:21		TARE kg	
					0.000		WEIGHT kg	
					0.410			
OPE 001	OPE 002	OPE 003	OPE 004	OPE 005	FIXED PRICE		£	
OPE 006	OPE 007	OPE 008	OPE 009	OPE 010	1.78			
OPE 011	OPE 012	OPE 013	OPE 014	OPE 015				
TARE	TARE	TARE	TARE	OPERATOR GROUP				

4-5 Press a button on the screen for the operator who has sold the product.

EXAMPLE Select "Operator 002".

PLU 201 21-JUN-2007(THU) 11:21					TARE kg
LIVE WILD CHERRYS CLAM(USA)					0.000
					WEIGHT kg
					0.410
OPE 001	OPE 002	OPE 003	OPE 004	OPE 005	
OPE 006	OPE 007	OPE 008	OPE 009	OPE 010	
OPE 011	OPE 012	OPE 013	OPE 014	OPE 015	
TARE	TARE	TARE	TARE	OPERATOR GROUP	FIXED PRICE £
					1.78

4-6 The subtotal for the selected operator is shown on the screen.

PLU 201 21-JUN-2007(THU) 11:21		OP 2	
LIVE WILD CHERRYS CLAM(USA)		ITEMS	
		3PC(S)	
		TOTAL	
		£8.10	
SUBTOTAL		£7.72	
VAT EXCL.		£0.38	
VAT INCL.		(£0.00)	
		ADDED PRICE £	
		1.78	

5-1 Select a desired product category by pressing the corresponding field on the screen.

EXAMPLE Select "Meat" category.

PLU 201 21-JUN-2007(THU) 11:21		OP 2	
LIVE WILD CHERRYS CLAM(USA)		ITEMS	
		3PC(S)	
		TOTAL	
		£8.10	
SUBTOTAL		£7.72	
VAT EXCL.		£0.38	
VAT INCL.		(£0.00)	
		ADDED PRICE £	
		1.78	

5-2 The PLU preset screen for the selected category appears. Then, enter a desired PLU number using the numeric keys and press the [PLU] key on the key sheet, or simply press a preset key on the screen where a desired product is allocated.

EXAMPLE Select PLU No.4 “Pork Chops”.



PLU 0					21-JUN-2007(THU) 11:21		TARE	kg
Check the weight before operation. Enter PLU No. and press [PLU] key.							0.000	
							ZERO	WEIGHT kg
							0.000	
RIB STEAK	TOP SIRLOIN WHOLE	ROUND STEAK BONELESS	PORK CHOPS BONELESS	SMOKED SAUSAGE			UNIT PRICE	£/kg
							0.00	
							TOTAL PRICE	£
							0.00	

5-3 The PLU screen appears.

Fixed Unit Price PLU

PLU 4					21-JUN-2007(THU) 11:21		FIXED WEIGHT	kg
PORK CHOPS BONELESS SIRLOIN								
OPE 001	OPE 002	OPE 003	OPE 004	OPE 005			FIXED U.PRI	£/kg
OPE 006	OPE 007	OPE 008	OPE 009	OPE 010			3.68	
OPE 011	OPE 012	OPE 013	OPE 014	OPE 015			TOTAL PRICE	£
TARE	TARE	TARE	TARE	OPERATOR GROUP			0.00	

5-4 Enter the weight using the numeric keys on the key sheet, and press the “Fixed Weight” field on the screen.

EXAMPLE Weight “400g”



PLU 4					21-JUN-2007(THU) 11:21		FIXED WEIGHT	kg
PORK CHOPS BONELESS SIRLOIN							0.400	
OPE 001	OPE 002	OPE 003	OPE 004	OPE 005			FIXED U.PRI	£/kg
OPE 006	OPE 007	OPE 008	OPE 009	OPE 010			3.68	
OPE 011	OPE 012	OPE 013	OPE 014	OPE 015			TOTAL PRICE	£
TARE	TARE	TARE	TARE	OPERATOR GROUP			1.47	

5-5 Press a button on the screen for the operator who has sold the product.

EXAMPLE Select "Operator 002".

PLU 4 21-JUN-2007(THU) 11:21					
PORK CHOPS BONELESS SIRLOIN					FIXED WEIGHT kg
					0.400
OPE 001	OPE 002	OPE 003	OPE 004	OPE 005	FIXED U.PRI £/kg
OPE 006	OPE 007	OPE 008	OPE 009	OPE 010	3.68
OPE 011	OPE 012	OPE 013	OPE 014	OPE 015	TOTAL PRICE £
TARE	TARE	TARE	TARE	OPERATOR GROUP	1.47

5-6 The subtotal for the selected operator is shown on the screen.

PLU 4 21-JUN-2007(THU) 11:21		OP 2	
PORK CHOPS BONELESS SIRLOIN		ITEMS	
		4PC(S)	
TOTAL DISPLAY		TOTAL	
		£9.64	
SUBTOTAL		£9.19	
VAT EXCL.		£0.45	
VAT INCL.		(£0.00)	
KEY LOCK <ON>		ADDED PRICE £	
		1.47	

6. Press the subtotal field on the screen to display more detailed subtotal data.

PLU 4 21-JUN-2007(THU) 11:21		OP 2	
PORK CHOPS BONELESS SIRLOIN		ITEMS	
		4PC(S)	
TOTAL DISPLAY		TOTAL	
		£9.64	
SUBTOTAL		£9.19	
VAT EXCL.		£0.45	
VAT INCL.		(£0.00)	
KEY LOCK <ON>		ADDED PRICE £	
		1.47	

7. The detailed subtotal screen appears for confirmation of product registrations. Then, confirm that the detail of the transaction is correct.

SUBTOTAL 21-JUN-2007(THU) 11:22					ITEMS 4PC(S)		
OP 2		TOTAL £9.64			(1)RIBSTEAK		
FIDELITY		SUBTOTAL £9.19			£/kg	kg	£
OPOINT(S)		VAT EXCL. £0.45			3.98	0.362	1.44
		VAT INCL. (£0.00)			(102)MAINE LOBSTERFRE:		
RECEIPT DELETE	RECEIPT <PRINT>	OPEN DRAWER	CREDIT	OTHER TRAN CASH	£/PC(S)	PC(S)	£
VOID	COUPON PAY	TAX PRN <NO-PRN>			4.50	1	4.50
					(201)LIVE WILD CHERRYS:		
				SUBTOTAL GROUP	kg		£
					0.410		1.78

8. Press the [PRINT] key on the key sheet to issue the receipt.



MEMBER SAVINGS				
* RECEIPT FOR PURCHASE *				
ISHIDA JAPAN				
http://www.ishida.co.jp/				
21-JUN-200711:20				
PLU	f/kg	kg	f	
RIB STEAK				
1	3.98	0.362	1.44	
FIDELITY POINT: 0 POINT(S)				
PLU	f/Pcs	Pcs	f	
MAINE LOBSTER FRESH DAILY				
102	4.50	1	4.50	
FIDELITY POINT: 0 POINT(S)				
PLU	f/kg	kg	f	
LIVE WILD CHERRYSTONE CLAM(USA)				
201		0.410	1.78	
FIDELITY POINT: 0 POINT(S)				
PLU	f/kg	kg	f	
PORK CHOPS BONELESS SIRLOIN				
4	3.68	0.400	1.47	
FIDELITY POINT: 0 POINT(S)				
4 items			Sub-total:	9.19
Total:			9.64	
TENDERED:			f9.64	
TOTAL FIDELITY POINT:			0 POINT	
21/06/2007 11:21 No. 0046 MACHINE 01				
 0 200000 909642 Welcome again. Thank You				

9. The Subtotal screen appears for the settlement.

SUBTOTAL(HOLD) 21-JUN-2007(THU) 11:22				ITEMS	4PC(S)
OP 2		TOTAL			£9.64
FIDELITY 0POINT(S)		SUBTOTAL		TENDERD	£9.64
		VAT EXCL.		CHANGE	£0.00
		VAT INCL.			
RECEIPT DELETE	RECEIPT <PRINT>	OPEN DRAWER	CREDIT	OTHER THAN CASH	
				CASH	£9.64
VOID	COUPON PAY	TAX PRN <NO-PRN>		COUPON	£0.00
				CREDIT	£0.00
				O.THAN CASH	£0.00
			SUBTOTAL GROUP		

3.2 SALES BY DIFFERENT OPRATORS

1. Ensure that the initial screen is displayed.

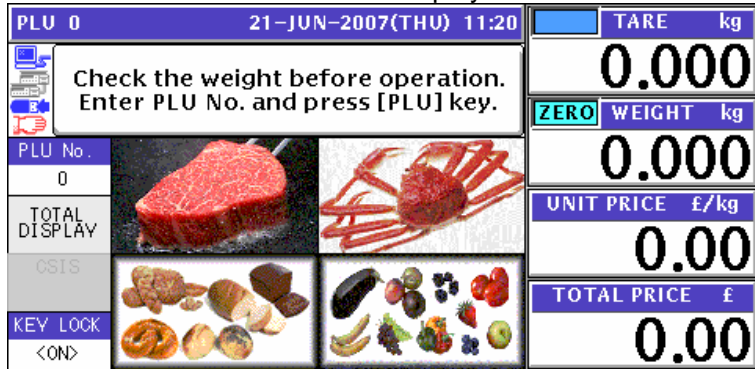

2-1 EXAMPLE Product registration by "Operator 002"

Select a desired product category by pressing the corresponding field on the screen.

EXAMPLE Select "Meat" category.



2-2 The PLU preset screen for the selected category appears. Then, enter a desired PLU number using the numeric keys and press the [PLU] key on the key sheet, or simply press a preset key on the screen where a desired product is allocated.

EXAMPLE Select PLU No.1 "Rib Steak".

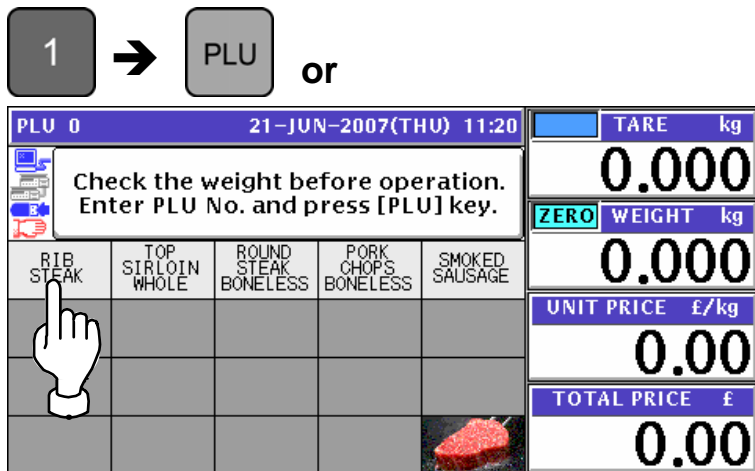

2-3 The PLU screen appears.

Weighing Unit Price PLU					
PLU 1 21-JUN-2007(THU) 11:20					
RIB STEAK					NET PT kg
					0.050
					ZERO WEIGHT kg
					-0.050
OPE 001	OPE 002	OPE 003	OPE 004	OPE 005	UNIT PRICE £/kg
OPE 006	OPE 007	OPE 008	OPE 009	OPE 010	3.98
OPE 011	OPE 012	OPE 013	OPE 014	OPE 015	TOTAL PRICE £
TARE	TARE	TARE	TARE	OPERATOR GROUP	0.00

2-4 Put a product on the weigh platter.



PLU 1 21-JUN-2007(THU) 11:20					
RIB STEAK					NET PT kg
					0.050
					WEIGHT kg
					0.362
OPE 001	OPE 002	OPE 003	OPE 004	OPE 005	UNIT PRICE £/kg
OPE 006	OPE 007	OPE 008	OPE 009	OPE 010	3.98
OPE 011	OPE 012	OPE 013	OPE 014	OPE 015	TOTAL PRICE £
TARE	TARE	TARE	TARE	OPERATOR GROUP	1.44

2-5 Press a button on the screen for the operator who has sold the product.

EXAMPLE Select "Operator 002".

PLU 1 21-JUN-2007(THU) 11:20					
RIB STEAK					NET PT kg
					0.050
					WEIGHT kg
					0.362
OPE 001	OPE 002	OPE 003	OPE 004	OPE 005	UNIT PRICE £/kg
OPE 006	OPE 007	OPE 008	OPE 009	OPE 010	3.98
OPE 011	OPE 012	OPE 013	OPE 014	OPE 015	TOTAL PRICE £
TARE	TARE	TARE	TARE	OPERATOR GROUP	1.44





2-6 The subtotal for the selected operator is shown on the screen.

PLU 1		21-JUN-2007(THU) 11:20		OP 2
RIB STEAK		ITEMS 1 PC(S)		
PLU No.			TOTAL £1.51	
TOTAL DISPLAY			SUBTOTAL £1.44	
KEY LOCK				VAT EXCL. £0.07
<ON>				VAT INCL. (£0.00)
				ADDED PRICE £
				1.44

3-1 EXAMPLE Product registration by "Operator 002"

Select a desired product category by pressing the corresponding field on the screen.

EXAMPLE Select "Fish" category.

PLU 1		21-JUN-2007(THU) 11:20		OP 2
RIB STEAK		ITEMS 1 PC(S)		
PLU No.			TOTAL £1.51	
TOTAL DISPLAY			SUBTOTAL £1.44	
KEY LOCK				VAT EXCL. £0.07
<ON>				VAT INCL. (£0.00)
				ADDED PRICE £
				1.44

3-2 The PLU preset screen for the selected category appears. Then, enter a desired PLU number using the numeric keys and press the [PLU] key on the key sheet, or simply press a preset key on the screen where a desired product is allocated.

EXAMPLE Select PLU No.102 "Maine Lobster".

1 0 2 → PLU or

PLU 1		21-JUN-2007(THU) 11:20		OP 2
RIB STEAK		ITEMS 1 PC(S)		
SALMON FILLET GUARANTE	MAINE LOBSTER FRESH	LAKE TROUT TRUCHAS	SHARK TIBURON	YELLOW FIN TUNA
				
				TOTAL £1.51
				SUBTOTAL £1.44
				VAT EXCL. £0.07
				VAT INCL. (£0.00)
				ADDED PRICE £
				1.44

3-3 The PLU screen appears.

Fixed Price PLU					
PLU 102 21-JUN-2007(THU) 11:20					
					PCS 1
					FIXED WEIGHT kg
OPE 001	OPE 002	OPE 003	OPE 004	OPE 005	
OPE 006	OPE 007	OPE 008	OPE 009	OPE 010	
OPE 011	OPE 012	OPE 013	OPE 014	OPE 015	FIXED PRICE £
TARE	TARE	TARE	TARE	OPERATOR GROUP	4.50

3-4 Press a button on the screen for the operator who has sold the product.

EXAMPLE Select "Operator 002".

PLU 102 21-JUN-2007(THU) 11:20					
					PCS 1
					FIXED WEIGHT kg
OPE 001	OPE 002	OPE 003	OPE 004	OPE 005	
OPE 006	OPE 007	OPE 008	OPE 009	OPE 010	
OPE 011	OPE 012	OPE 013	OPE 014	OPE 015	FIXED PRICE £
TARE	TARE	TARE	TARE	OPERATOR GROUP	4.50

3-5 The subtotal for the selected operator is shown on the screen.

PLU 102 21-JUN-2007(THU) 11:20					OP 2
					ITEMS
					2PC(S)
TOTAL DISPLAY					TOTAL
					£6.23
SUBTOTAL					£5.94
VAT EXCL.					£0.29
VAT INCL.					(£0.00)
KEY LOCK <ON>					ADDED PRICE £
					4.50

4-1 EXAMPLE Product registration by "Operator 001"

Select a desired product category by pressing the corresponding field on the screen.

EXAMPLE Select "Bakery" category.

PLU 0 21-JUN-2007(THU) 11:21					TARE kg
					0.000
					ZERO WEIGHT kg
TOTAL DISPLAY					0.000
					UNIT PRICE £/kg
					0.00
KEY LOCK <ON>					TOTAL PRICE £
					0.00

- 4-2** The PLU preset screen for the selected category appears. Then, enter a desired PLU number using the numeric keys and press the [PLU] key on the key sheet, or simply press a preset key on the screen where a desired product is allocated.

EXAMPLE Select PLU No.201 "Live Wild Cherry Clam".

2 0 1 → PLU or

PLU 0					21-JUN-2007(THU) 11:21		TARE	kg	0.000	
Check the weight before operation. Enter PLU No. and press [PLU] key.							ZERO	WEIGHT	kg	0.000
LIVE WILD CHERRYS CLAM(USA)	HAM SANDWICH	BREAKFAST SANDWICH	MEXICAN 7 LAYER DIP	HOT BARBECUE SPARE RI			UNIT PRICE	£/kg	0.00	
							TOTAL PRICE	£	0.00	

- 4-3** The PLU screen appears.

Weighing Fixed Price PLU

PLU 201					21-JUN-2007(THU) 11:21		TARE	kg	0.000	
LIVE WILD CHERRYS CLAM(USA)							ZERO	WEIGHT	kg	0.000
OPE 001	OPE 002	OPE 003	OPE 004	OPE 005						
OPE 006	OPE 007	OPE 008	OPE 009	OPE 010						
OPE 011	OPE 012	OPE 013	OPE 014	OPE 015			FIXED PRICE	£	1.78	
TARE	TARE	TARE	TARE	OPERATOR GROUP						

- 4-4** Put a product on the weigh platter.

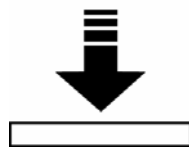

PRODUCT



PLU 201					21-JUN-2007(THU) 11:21		TARE	kg	0.000
LIVE WILD CHERRYS CLAM(USA)							WEIGHT	kg	0.410
OPE 001	OPE 002	OPE 003	OPE 004	OPE 005					
OPE 006	OPE 007	OPE 008	OPE 009	OPE 010					
OPE 011	OPE 012	OPE 013	OPE 014	OPE 015			FIXED PRICE	£	1.78
TARE	TARE	TARE	TARE	OPERATOR GROUP					

4-5 Press a button on the screen for the operator who has sold the product.

EXAMPLE Select "Operator 001".

PLU 201					21-JUN-2007(THU) 11:21					TARE kg	
   LIVE WILD CHERRYS CLAM(USA)										0.000	
										WEIGHT kg	
										0.410	
OPE 001	OPE 002	OPE 003	OPE 004	OPE 005						FIXED PRICE £	
OPE 006	OPE 007	OPE 008	OPE 009	OPE 010						1.78	
OPE 011	OPE 012	OPE 013	OPE 014	OPE 015							
TARE	TARE	TARE	TARE	OPERATOR GROUP							

4-6 The subtotal for the selected operator is shown on the screen.

PLU 201					21-JUN-2007(THU) 11:22					OP 1	
   LIVE WILD CHERRYS CLAM(USA)										ITEMS	
										TOTAL	
PLU No.	TOTAL DISPLAY		 							SUBTOTAL	
201										£1.78	
KEY LOCK	 							VAT EXCL.		£0.08	
<ON>								VAT INCL.		(£0.00)	
										ADDED PRICE £	
										1.78	

5-1 EXAMPLE Product registration by "Operator 002"

Select a desired product category by pressing the corresponding field on the screen.

EXAMPLE Select "Meat" category.

PLU 0					21-JUN-2007(THU) 11:21					TARE kg	
   Check the weight before operation. Enter PLU No. and press [PLU] key.										0.000	
										ZERO WEIGHT kg	
PLU No.	TOTAL DISPLAY		 							UNIT PRICE £/kg	
0										0.00	
KEY LOCK	 							TOTAL PRICE £		0.00	
<ON>											

- 5-2** The PLU preset screen for the selected category appears. Then, enter a desired PLU number using the numeric keys and press the [PLU] key on the key sheet, or simply press a preset key on the screen where a desired product is allocated.

EXAMPLE Select PLU No.4 “Pork Chops”.

4 → PLU or

PLU 0					21-JUN-2007(THU) 11:21		TARE	kg
							0.000	
							WEIGHT	kg
							0.000	
RIB STEAK	TOP SIRLOIN WHOLE	ROUND STEAK BONELESS	PORK CHOPS BONELESS	SMOKED SAUSAGE			UNIT PRICE	£/kg
							0.00	
							TOTAL PRICE	£
							0.00	

- 5-3** The PLU screen appears.

Fixed Unit Price PLU

PLU 4					21-JUN-2007(THU) 11:21			
							FIXED WEIGHT	kg
OPE 001	OPE 002	OPE 003	OPE 004	OPE 005			FIXED U.PRI	£/kg
OPE 006	OPE 007	OPE 008	OPE 009	OPE 010			3.68	
OPE 011	OPE 012	OPE 013	OPE 014	OPE 015			TOTAL PRICE	£
TARE	TARE	TARE	TARE	OPERATOR GROUP			0.00	

- 5-4** Enter the weight using the numeric keys on the key sheet, and press the “Fixed Weight” field on the screen.

EXAMPLE Weight “400g”

4 0 0

PLU 4					21-JUN-2007(THU) 11:21			
							FIXED WEIGHT	kg
							0.400	
OPE 001	OPE 002	OPE 003	OPE 004	OPE 005			FIXED U.PRI	£/kg
OPE 006	OPE 007	OPE 008	OPE 009	OPE 010			3.68	
OPE 011	OPE 012	OPE 013	OPE 014	OPE 015			TOTAL PRICE	£
TARE	TARE	TARE	TARE	OPERATOR GROUP			1.47	

5-5 Press a button on the screen for the operator who has sold the product.

EXAMPLE Select "Operator 002".

PLU 4 21-JUN-2007(THU) 11:21					
PORK CHOPS BONELESS SIRLOIN					FIXED WEIGHT kg
					0.400
OPE 001	OPE 002	OPE 003	OPE 004	OPE 005	FIXED U.PRI £/kg
OPE 006	OPE 007	OPE 008	OPE 009	OPE 010	3.68
OPE 011	OPE 012	OPE 013	OPE 014	OPE 015	TOTAL PRICE £
TARE	TARE	TARE	TARE	OPERATOR GROUP	1.47

5-6 The subtotal for the selected operator is shown on the screen.

PLU 4 21-JUN-2007(THU) 11:22		OP 2	
PORK CHOPS BONELESS SIRLOIN		ITEMS 3PC(S)	
PLU No. 4			TOTAL £7.78
TOTAL DISPLAY			SUBTOTAL £7.41
KEY LOCK <ON>			VAT EXCL. £0.37
			VAT INCL. (£0.00)
			ADDED PRICE £
			1.47

6. Press the subtotal field on the screen to display more detailed subtotal data.

PLU 4 21-JUN-2007(THU) 11:22		OP 2	
PORK CHOPS BONELESS SIRLOIN		ITEMS 3PC(S)	
PLU No. 4			TOTAL £7.78
TOTAL DISPLAY			SUBTOTAL £7.41
KEY LOCK <ON>			VAT EXCL. £0.37
			VAT INCL. (£0.00)
			ADDED PRICE £
			1.47

7. The detailed subtotal screen appears for confirmation of product registrations. Then, confirm that the detail of the transaction is correct.

SUBTOTAL 21-JUN-2007(THU) 11:21					ITEMS 3PC(S)		
OP 2		TOTAL £7.78			(1)RIBSTEAK		
FIDELITY		SUBTOTAL £7.41			£/kg	kg	£
OPOINT(S)		VAT EXCL. £0.37			3.98	0.362	1.44
		VAT INCL. (£0.00)			(102)MAINE LOBSTERFRE:		
RECEIPT DELETE	RECEIPT <PRINT>	OPEN DRAWER	CREDIT	OTHER TRAN CASH	£/PC(S)	PC(S)	£
VOID	COUPON PAY	TAX PRN <NO-PRN>			4.50	1	4.50
					(4)PORK CHOPSBONELE:		
				SUBTOTAL GROUP	£/kg	kg	£
					3.68	0.400	1.47

8. Press the [PRINT] key on the key sheet to issue the receipt.

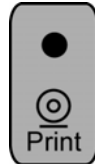

MEMBER SAVINGS

* RECEIPT FOR PURCHASE *

ISHIDA JAPAN
http://www.ishida.co.jp/
21-JUN-2007 11:20

PLU	£/kg	kg	£
RIB STEAK			
1	3.98	0.362	1.44
FIDELITY POINT: 0 POINT(S)			

PLU	£/Pcs	Pcs	£
MAINE LOBSTER FRESH DAILY			
102	4.50	1	4.50
FIDELITY POINT: 0 POINT(S)			

PLU	£/kg	kg	£
PORK CHOPS BONELESS SIRLOIN			
4	3.68	0.400	1.47
FIDELITY POINT: 0 POINT(S)			

3 items **Sub-total: 7.41**

Total: 7.78

TENDERED: £7.78

TOTAL FIDELITY POINT: 0 POINT

21/06/2007 11:21 No. 0060 MACHINE 01

0 200000 007782
Welcome again.
Thank You





9. The Subtotal screen appears for the settlement.

SUBTOTAL(HOLD) 21-JUN-2007(THU) 11:21				ITEMS	3PC(S)
OP 2		TOTAL	£7.78	TENDERD	£7.78
FIDELITY 0POINT(S)		SUBTOTAL	£7.41	CHANGE	£0.00
		VAT EXCL.	£0.37		
		VAT INCL.	(£0.00)		
RECEIPT DELETE	RECEIPT <PRINT>	OPEN DRAWER	CREDIT	OTHER THAN CASH	CASH £7.78
VOID	COUPON PAY	TAX PRN <NO-PRN>			COUPON £0.00
					CREDIT £0.00
				SUBTOTAL GROUP	OTHER THAN CASH £0.00

10-1 EXAMPLE Product registration by “Operator 001”

Select a desired product category by pressing the corresponding field on the screen.

EXAMPLE Select “Meat” category.

PLU 0		21-JUN-2007(THU) 11:23		TARE	kg
Check the weight before operation. Enter PLU No. and press [PLU] key.				0.000	
PLU No.	0			ZERO	WEIGHT kg
TOTAL DISPLAY		 		0.000	
KEY LOCK		 		UNIT PRICE	£/kg
<ON>				0.00	
				TOTAL PRICE	£
				0.00	

10-2 The PLU preset screen for the selected category appears.

Then, enter a desired PLU number using the numeric keys and press the [PLU] key on the key sheet, or simply press a preset key on the screen where a desired product is allocated.

EXAMPLE Select PLU No.3 “Round Steak”.

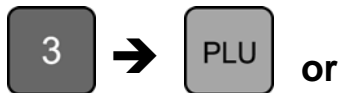

PLU 0		21-JUN-2007(THU) 11:23		TARE	kg
Check the weight before operation. Enter PLU No. and press [PLU] key.				0.000	
RIB STEAK	TOP SIRLOIN WHOLE	ROUND STEAK BONELESS	PORK CHOPS BONELESS	SMOKED SAUSAGE	
TOTAL DISPLAY				0.000	
KEY LOCK				UNIT PRICE	£/kg
<ON>				0.00	
				TOTAL PRICE	£
				0.00	

10-3 The PLU screen appears.



Weighing Unit Price PLU

PLU 3		21-JUN-2007(THU) 11:23		TARE	kg
ROUND STEAK BONELESS				0.000	
OPE 001	OPE 002	OPE 003	OPE 004	OPE 005	
OPE 006	OPE 007	OPE 008	OPE 009	OPE 010	
OPE 011	OPE 012	OPE 013	OPE 014	OPE 015	
TARE	TARE	TARE	TARE	OPERATOR GROUP	
				FIXED PRICE	£
				3.98	

10-4 Put a product on the weigh platter.



PRODUCT



PLU 3					21-JUN-2007(THU) 11:23					TARE	kg
  ROUND STEAK BONELESS										0.000	
										WEIGHT	kg
OPE 001	OPE 002	OPE 003	OPE 004	OPE 005							
OPE 006	OPE 007	OPE 008	OPE 009	OPE 010							
OPE 011	OPE 012	OPE 013	OPE 014	OPE 015							
TARE	TARE	TARE	TARE	OPERATOR GROUP						FIXED PRICE	£
										3.98	

10-5 Press a button on the screen for the operator who has sold the product.

EXAMPLE Select "Operator 001".

PLU 3					21-JUN-2007(THU) 11:23					TARE	kg
  ROUND STEAK BONELESS										0.000	
										WEIGHT	kg
OPE 001	OPE 002	OPE 003	OPE 004	OPE 005							
OPE 006	OPE 007	OPE 008	OPE 009	OPE 010							
OPE 011	OPE 012	OPE 013	OPE 014	OPE 015							
TARE	TARE	TARE	TARE	OPERATOR GROUP						FIXED PRICE	£
										3.98	

10-6 The subtotal for the selected operator is shown on the screen.

PLU 3					21-JUN-2007(THU) 11:23					OP 1	
  ROUND STEAK BONELESS										ITEMS	2PC(S)
										TOTAL	£6.04
PLU No.										SUBTOTAL	£5.76
3										VAT EXCL.	£0.28
TOTAL DISPLAY										VAT INCL.	(£0.00)
KEY LOCK										ADDED PRICE	£
<ON>										3.98	

11 EXAMPLE Receipt issue by "Operator 001"

Press the subtotal field on the screen to display more detailed subtotal data.

PLU 3		21-JUN-2007(THU) 11:23		OP 1	
ROUND STEAK BONELESS				ITEMS 2PC(S)	
PLU No.			TOTAL £6.04		
3			SUBTOTAL £5.76		
TOTAL DISPLAY			VAT EXCL. £0.28		
			VAT INCL. (£0.00)		
KEY LOCK			ADDED 3.98		
<ON>			3.98		

12 The Subtotal screen appears for confirmation of product registrations.

SUBTOTAL		21-JUN-2007(THU) 11:23		ITEMS 2PC(S)	
OP 1		TOTAL £6.04		({ 201)LIVE WILD CHERRYS	
FIDELITY 0POINT(S)		SUBTOTAL £5.76		kg £	
		VAT EXCL. £0.28		0.410 1.78	
		VAT INCL. (£0.00)		({ 3)ROUND STEAKBONEL	
RECEIPT DELETE	RECEIPT <PRINT>	OPEN DRAWER	CREDIT	OTHER TRAN CASH	kg £
VOID	COUPON PAY	TAX PRN <NO-PRN>			0.412 3.98
				SUBTOTAL GROUP	

13 Press the [PRINT] key on the key sheet to issue the receipt.

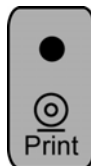

MEMBER SAVINGS

* RECEIPT FOR PURCHASE *

ISHIDA JAPAN
 http://www.ishida.co.jp/
 21-JUN-2007 11:21

PLU	f/kg	kg	f
LIVE WILD CHERRYSTONE CLAM(USA)			
201		0.410	1.78
FIDELITY POINT: 0 POINT(S)			
ROUND STEAK BONELESS			
3		0.412	3.98
FIDELITY POINT: 0 POINT(S)			
2 items Sub-total:			5.76
Total:			6.04
TENDERED:			£6.04
TOTAL FIDELITY POINT:			0 POINT
21/06/2007 11:23 No. 0062 MACHINE 01			

0 200000 706043
 Welcome again.
Thank You

14 The Subtotal screen appears for the settlement.

SUBTOTAL(HOLD) 21-JUN-2007(THU) 11:23				ITEMS	2PC(S)
OP 1		TOTAL			£6.04
FIDELITY		SUBTOTAL		TENDERD	£6.04
0POINT(S)		VAT EXCL.		CHANGE	£0.00
		VAT INCL.			
RECEIPT DELETE	RECEIPT <PRINT>	OPEN DRAWER	CREDIT	OTHER THAN CASH	
VOID	COUPON PAY	TAX PRN		CASH	£6.04
		<NO-PRN>		COUPON	£0.00
				CREDIT	£0.00
				OTHER THAN CASH	£0.00
				SUBTOTAL GROUP	£0.00

3.3 VOIDING PRODUCT REGISTRATION

- To void a product registration that has been made in the transaction, display the Subtotal screen for confirmation of product registrations.

SUBTOTAL					21-JUN-2007(THU) 11:33		ITEMS	3PC(S)	
OP 2		TOTAL		£7.47		((3)ROUND STEAKBONEL		
FIDELITY		SUBTOTAL		£7.12					
		VAT EXCL.		£0.35					
		VAT INCL.		(£0.00)					
RECEIPT DELETE	RECEIPT <PRINT>	OPEN DRAWER	CREDIT	OTHER TRAN CASH		((103)LAKE TROUTTRUCH.		
VOID	COUPON PAY	TAX PRN <NO-PRN>				£/PC(S)	PC(S)	£	
						2.50	1	2.50	
						((205)HOT BARBECUESPAF		
						£/kg	kg	£	
					SUBTOTAL GROUP	2.38	0.268	0.64	

- Press to select a desired product registration field.

EXAMPLE Void the third item.

SUBTOTAL(HOLD)					21-JUN-2007(THU) 11:33		ITEMS	3PC(S)	
OP 2		TOTAL		£7.47		((3)ROUND STEAKBONEL		
FIDELITY		SUBTOTAL		£7.12					
		VAT EXCL.		£0.35					
		VAT INCL.		(£0.00)					
RECEIPT DELETE	RECEIPT <PRINT>	OPEN DRAWER	CREDIT	OTHER TRAN CASH		((103)LAKE TROUTTRUCH.		
VOID	COUPON PAY	TAX PRN <NO-PRN>				£/PC(S)	PC(S)	£	
						2.50	1	2.50	
						((205)HOT BARBECUESPAF		
						£/kg	kg	£	
					SUBTOTAL GROUP	2.38	0.268	0.64	

Note: To scroll the selection up or down, press the [**▲**] or [**▼**] keys on the key sheet.

- Press the [VOID] button on the screen.

SUBTOTAL(HOLD)					21-JUN-2007(THU) 11:33		ITEMS	3PC(S)	
OP 2		TOTAL		£7.47		((3)ROUND STEAKBONEL		
FIDELITY		SUBTOTAL		£7.12					
		VAT EXCL.		£0.35					
		VAT INCL.		(£0.00)					
RECEIPT DELETE	RECEIPT <PRINT>	OPEN DRAWER	CREDIT	OTHER TRAN CASH		((103)LAKE TROUTTRUCH.		
VOID	COUPON PAY	TAX PRN <NO-PRN>				£/PC(S)	PC(S)	£	
						2.50	1	2.50	
						((205)HOT BARBECUESPAF		
						£/kg	kg	£	
					SUBTOTAL GROUP	2.38	0.268	0.64	

- The confirmation screen appears. Then, press the [EXEC] button for execution.

SUBTOTAL(HOLD)					21-JUN-2007(THU) 11:33		ITEMS	3PC(S)	
DESIGNATED CORRECTION									
DO YOU WANT TO DELETE DESIGNATED PRODUCT?									
1827 - 0000					EXEC		STOP		

5. The selected item has been voided.

SUBTOTAL				21-JUN-2007(THU) 11:33		ITEMS		2PC(S)	
OP 2		TOTAL		£6.80		(3)ROUND STEAKBONEL			
FIDELITY		SUBTOTAL		£6.48		kg		£	
0POINT(S)		VAT EXCL.		£0.32		0.412		3.98	
		VAT INCL.		(£0.00)					
RECEIPT DELETE	RECEIPT <PRINT>	OPEN DRAWER	CREDIT	OTHER TRAN CASH		(103)LAKE TROUTTRUCH.			
VOID	COUPON PAY	TAX PRN <NO-PRN>				E/PC(S)	PC(S)	£	
						2.50	1	2.50	
						(205)HOT BARBECUESPAF			
						E/kg	kg	£	
					SUBTOTAL GROUP	2.38	0.268	0.64	

6. Press the [PRINT] key on the key sheet to issue the receipt.

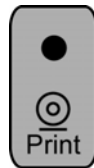

MEMBER SAVINGS

* RECEIPT FOR PURCHASE *

ISHIDA JAPAN
<http://www.ishida.co.jp/>
 21-JUN-200711:32

PLU	£/kg	kg	£
ROUND STEAK BONELESS			
3	0.412		3.98
FIDELITY POINT: 0 POINT(S)			
PLU	£/Pcs	Pcs	£
LAKE TROUT TRUCHAS			
103	2.50	1	2.50
FIDELITY POINT: 0 POINT(S)			
PLU	£/kg	kg	£
HOT BARBECUE SPARE RIB PLATTER			
205	2.38	0.268	0.64
FIDELITY POINT: 0 POINT(S)			

2 items **Sub-total: 6.48**

Total: 6.80

TENDERED: £6.80

TOTAL FIDELITY POINT: 0 POINT

21/06/2007 11:33 No. 0038 MACHINE 01



0 200000 506803

Welcome again.

Thank You

Deleted by a dashed line

7. The Subtotal screen appears for the settlement.

SUBTOTAL(HOLD) 21-JUN-2007(THU) 11:33					ITEMS	2PC(S)
OP 2		TOTAL				£6.80
FIDELITY 0POINT(S)		SUBTOTAL			TENDERD	£6.80
		VAT EXCL.			CHANGE	£0.00
		VAT INCL.				
RECEIPT DELETE	RECEIPT <PRINT>	OPEN DRAWER	CREDIT	OTHER THAN CASH	CASH	£6.80
VOID	COUPON PAY	TAX PRN <NO-PRN>			COUPON	£0.00
					CREDIT	£0.00
				SUBTOTAL GROUP	O.THAN CASH	£0.00

TRACEABILITY PRODUCTS

4.1 REFERRING TO PREVIOUS TRACEABILITY DATA

1. Ensure that the initial screen is displayed.

PLU 0					21-JUN-2007(THU) 11:15		TARE	kg	0.000
					Check the weight before operation. Enter PLU No. and press [PLU] key.		WEIGHT	kg	0.000
PLU No.				PRN MD.					
0				<MANUAL>					
RIB STEAK	TOP SIRLOIN WHOLE	ROUND STEAK BONELESS	PORK CHOPS BONELESS	SMOKED SAUSAGE	UNIT PRICE £/kg				
ROAST BEEF	T-BONE STEAK	GROUND BEEF EXTRA	MAINE LOBSTER FRESH	SALMON FILLET GUARANTEE	0.00				
CASSETTE	HAM SANDWICH	HOT SWEET & SOUR WIN	TILAPIA FILLET SKIN-ON	VOID	TOTAL PRICE £				
1					0.00				

2. Enter a desired PLU number using the numeric keys and press the [PLU] key on the key sheet, or simply press a preset key on the screen where the product is allocated.

EXAMPLE PLU number "6".



PLU 0					21-JUN-2007(THU) 11:15		TARE	kg	0.000
					Check the weight before operation. Enter PLU No. and press [PLU] key.		WEIGHT	kg	0.000
No.				PRN MD.					
6				<MANUAL>					
RIB STEAK	TOP SIRLOIN WHOLE	ROUND STEAK BONELESS	PORK CHOPS BONELESS	SMOKED SAUSAGE	UNIT PRICE £/kg				
ROAST BEEF	T-BONE STEAK	GROUND BEEF EXTRA	MAINE LOBSTER FRESH	SALMON FILLET GUARANTEE	0.00				
CASSETTE	HAM SANDWICH	HOT SWEET & SOUR WIN	TILAPIA FILLET SKIN-ON	VOID	TOTAL PRICE £				
1					0.00				

3. When the product is preset as a traceable item, the Traceability screen appears.

TRACEABILITY			21-JUN-2007(THU) 11:15	
6	ROAST BEEF			
LOT	0123456789			
TITLE TEXT	COUNTRY	FACTORY		
Born in:	ARGENTINA	ATTR.1-1		
Breed in:	ARGENTINA	ATTR.1-1		
Breed in #2:	FRANCE	ATTR.2-2		
Slaughtered in:	FRANCE	ATTR.2-2		
Cut Up in:	FRANCE	ATTR.2-2		
			INPUT	

4. To refer to the previously processed traceability data, press the [LIST] button.

TRACEABILITY			21-JUN-2007(THU) 11:15	
6	ROAST BEEF			
LOT	0123456789			
TITLE TEXT	COUNTRY	FACTORY		
Born in:	ARGENTINA	ATTR.1-1		
Breed in:	ARGENTINA	ATTR.1-1		
Breed in #2:	FRANCE	ATTR.2-2		
Slaughtered in:	FRANCE	ATTR.2-2		
Cut Up in:	FRANCE	ATTR.2-2		
INPUT			LIST	SET

5. The Traceability History screen appears. Then, press to select a desired data field.

TRACEABILITY HISTORY		21-JUN-2007(THU) 11:15		1/1
DATE/TIME	LOT			
21-JUN-2007 11:15:47	0123456789			
INPUT		SET	DELETE	

6. The selected data appears. Then, press the [SET] button.

TRACEABILITY			21-JUN-2007(THU) 11:15	
6	ROAST BEEF			
LOT	0123456789			
TITLE TEXT	COUNTRY	FACTORY		
Born in:	ARGENTINA	ATTR.1-1		
Breed in:	ARGENTINA	ATTR.1-1		
Breed in #2:	FRANCE	ATTR.2-2		
Slaughtered in:	FRANCE	ATTR.2-2		
Cut Up in:	FRANCE	ATTR.2-2		
INPUT			SET	SET

7. The selected PLU screen appears.

Weighing Unit Price Products				
PLU 6		21-JUN-2007(THU) 11:15		TARE kg
ROAST BEEF			0.000	
			ZERO WEIGHT kg	0.000
U/P	F/P	FIX UPR	FIX UPR +WEIGHT	COUPONMS
SPECIAL	-\$	-%	SP. (U/P)	-\$ (U/P)
0.00	0.00	0.0	0.00	0.00
-% (U/P)	P DATE	S DATE	TOTALADD	PRN QTY
0.0	21-06-07	27-06-07	<ADD>	0
PRN MD.	PEEL MD.	CASSETTE	MULTI	FUNCTION GROUP
<MANUAL>	<INDIV>	1		
				UNIT PRICE £/kg
				4.00
				TOTAL PRICE £
				0.00

Fixed Price Products

PLU 6 21-JUN-2007(THU) 11:15					PCS	1
 ROAST BEEF					FIXED WEIGHT kg	
U/P	F/P	FIX UPR	FIX UPR +WEIGHT	COUPONMS		
SPECIAL	-\$	-%	SP. (U/P)	-\$ (U/P)		
0.00	0.00	0.0	0.00	0.00		
-(U/P)	P DATE	S DATE	TOTALADD	PRN QTY	FIXED PRICE £	
0.0	21-06-07	27-06-07	<ADD>	0	4.00	
PRN MD.	PEEL MD.	CASSETTE	MULTI	FUNCTION GROUP		
<MANUAL>	<INDIV>	1				

Fixed Unit Price Products

PLU 6 21-JUN-2007(THU) 11:15						
 ROAST BEEF					FIXED WEIGHT kg	
U/P	F/P	FIX UPR	FIX UPR +WEIGHT	COUPONMS	FIXED U.PRI £/kg	
SPECIAL	-\$	-%	SP. (U/P)	-\$ (U/P)	4.00	
0.00	0.00	0.0	0.00	0.00		
-(U/P)	P DATE	S DATE	TOTALADD	PRN QTY	TOTAL PRICE £	
0.0	21-06-07	27-06-07	<ADD>	0	0.00	
PRN MD.	PEEL MD.	CASSETTE	MULTI	FUNCTION GROUP		
<MANUAL>	<INDIV>	1				

Weighing Fixed Price Products

PLU 6 21-JUN-2007(THU) 11:15					TARE	kg
 ROAST BEEF					0.000	
					ZERO	WEIGHT kg
					0.000	
U/P	F/P	FIX UPR	FIX UPR +WEIGHT	COUPONMS		
SPECIAL	-\$	-%	SP. (U/P)	-\$ (U/P)		
0.00	0.00	0.0	0.00	0.00		
-(U/P)	P DATE	S DATE	TOTALADD	PRN QTY	FIXED PRICE £	
0.0	21-06-07	27-06-07	<ADD>	0	4.00	
PRN MD.	PEEL MD.	CASSETTE	MULTI	FUNCTION GROUP		
<MANUAL>	<INDIV>	1				

4.2 CHANGING TRACEABILITY DATA

1. Ensure that the initial screen is displayed.

PLU 0 21-JUN-2007(THU) 11:15					TARE kg
Check the weight before operation. Enter PLU No. and press [PLU] key.					0.000
					WEIGHT kg
					0.000
					UNIT PRICE £/kg
					0.00
					TOTAL PRICE £
					0.00

PLU No.					PRN MD.
0					<MANUAL>
RIB STEAK	TOP SIRLOIN WHOLE	ROUND STEAK BONELESS	PORK CHOPS BONELESS	SMOKED SAUSAGE	
ROAST BEEF	T-BONE STEAK	GROUND BEEF EXTRA	MAINE LOBSTER FRESH	SALMON FILLET GUARANTEE	
CASSETTE	HAM SANDWICH	HOT SWEET & SOUR WIN	TILAPIA FILLET SKIN-ON	VOID	
1					

2. Enter a desired PLU number using the numeric keys and press the [PLU] key on the key sheet, or simply press a preset key on the screen where the product is allocated.

EXAMPLE PLU number "6".



PLU 0 21-JUN-2007(THU) 11:15					TARE kg
Check the weight before operation. Enter PLU No. and press [PLU] key.					0.000
					WEIGHT kg
					0.000
					UNIT PRICE £/kg
					0.00
					TOTAL PRICE £
					0.00

No.					PRN MD.
0					<MANUAL>
RIB STEAK	TOP SIRLOIN WHOLE	ROUND STEAK BONELESS	PORK CHOPS BONELESS	SMOKED SAUSAGE	
ROAST BEEF	T-BONE STEAK	GROUND BEEF EXTRA	MAINE LOBSTER FRESH	SALMON FILLET GUARANTEE	
CASSETTE	HAM SANDWICH	HOT SWEET & SOUR WIN	TILAPIA FILLET SKIN-ON	VOID	
1					

3-1 When the product is preset as a traceable item, the Traceability screen appears. Then, confirm whether information on the screen is correct or not. When the data is correct, press the [SET] button.

TRACEABILITY			21-JUN-2007(THU) 11:15
6	ROAST BEEF		
LOT	0123456789		
TITLE TEXT	COUNTRY	FACTORY	
Born in:	ARGENTINA	ATTR.1-1	
Breed in:	FRANCE	ATTR.2-2	
Breed in #2:	FRANCE	ATTR.2-2	
Slaughtered in:	FRANCE	ATTR.2-2	
Cut Up in:	FRANCE	ATTR.2-2	
INPUT			 <input type="button" value="SET"/>

3-2 If the data is not correct, press to select a desired data field.

EXAMPLE Select "France".

TRACEABILITY			21-JUN-2007(THU) 11:15	
6	ROAST BEEF			
LOT	0123456789			
TITLE TEXT	COUNTRY	FACTORY		
Born in:	ARGENTINA	ATTR.1-1		
Breed in:	FRANCE	ATTR.2-2		
Breed in #2:	FRANCE	ATTR.2-2		
Slaughtered in:	FRANCE	ATTR.2-2		
Cut Up in:	FRANCE	ATTR.2-2		
			LIST	SET
			INPUT	

EXAMPLE Change to "Argentina".

LOOKUP TABLE		21-JUN-2007(THU) 11:15		1/2
0	NONE			
1	ARGENTINA			
2	FRANCE			
3	NETHERLANDS			
4	ENGLAND			
5	PORTUGAL			
FIND PLU		SEARCH	INPUT	

The data has been changed.

To change the "FACTORY" data, press the corresponding field.

TRACEABILITY			21-JUN-2007(THU) 11:15	
6	ROAST BEEF			
LOT	0123456789			
TITLE TEXT	COUNTRY	FACTORY		
Born in:	ARGENTINA	ATTR.1-1		
Breed in:	ARGENTINA			
Breed in #2:	FRANCE	ATTR.2-2		
Slaughtered in:	FRANCE	ATTR.2-2		
Cut Up in:	FRANCE	ATTR.2-2		
			LIST	SET
			INPUT	

Press to select a desired data field.

LOOKUP TABLE DATA		21-JUN-2007(THU) 11:15		1/3
0	NONE			
1	ATTR.1-1			
5	ATTR.1-5			
7	ATTR.1-7			
10	ATTR.1-10			
12	ATTR.1-12			
FIND PLU		SEARCH	DISP. LINE 1	INPUT

The data has been changed. Then, press the [SET] button.

TRACEABILITY			21-JUN-2007(THU) 11:15
6	ROAST BEEF		
LOT	0123456789		
TITLE TEXT	COUNTRY	FACTORY	
Born in:	ARGENTINA	ATTR.1-1	
Breed in:	ARGENTINA	ATTR.1-1	
Breed in #2:	FRANCE	ATTR.2-2	
Slaughtered in:	FRANCE	ATTR.2-2	
Cut Up in:	FRANCE	ATTR.2-2	
INPUT			<input type="button" value="OK"/> <input type="button" value="SET"/>

4. When changing the lot data, press the "LOT" field.

TRACEABILITY			21-JUN-2007(THU) 11:15
6	ROAST BEEF		
LOT	0123456789		
TITLE TEXT	COUNTRY	FACTORY	
Born in:	ARGENTINA	ATTR.1-1	
Breed in:	ARGENTINA	ATTR.1-1	
Breed in #2:	FRANCE	ATTR.2-2	
Slaughtered in:	FRANCE	ATTR.2-2	
Cut Up in:	FRANCE	ATTR.2-2	
INPUT			<input type="button" value="LIST"/> <input type="button" value="SET"/>

The Traceability Lot Number Set screen appears.

TRACEABILITY LOT NUMBER SET		21-JUN-2007(THU) 11:15							
0123456789									
Q	W	E	R	T	Y	U	I	O	P
A	S	D	F	G	H	J	K	L	
	Z	X	C	V	B	N	M		
<input type="button" value="ABC"/>		<input type="button" value="ERASE"/>	<input type="button" value="BACK SPACE"/>	<input type="button" value="BACK"/>					

Change the lot number using the [ABC] [ERASE] and [BACK SPACE] buttons, and press the [BACK] button to finish.

TRACEABILITY LOT NUMBER SET		21-JUN-2007(THU) 11:15							
ABC0123456789									
Q	W	E	R	T	Y	U	I	O	P
A	S	D	F	G	H	J	K	L	
	Z	X	C	V	B	N	M		
<input type="button" value="ABC"/>		<input type="button" value="ERASE"/>	<input type="button" value="BACK SPACE"/>	<input type="button" value="BACK"/>					

The confirmation screen appears. Then, press the [SAVE] button to save the data.

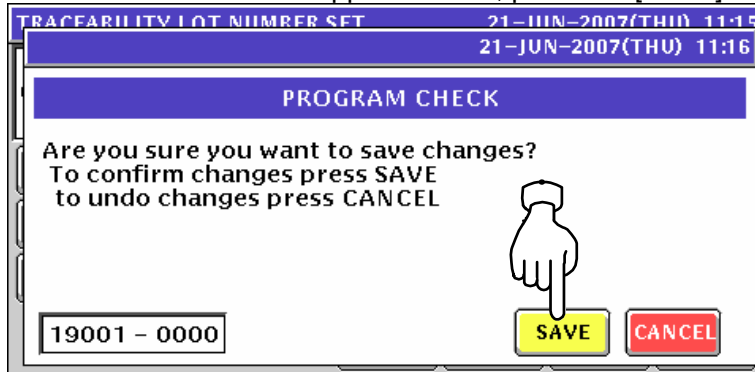

The Traceability screen appears. Then, press the [SET] button.

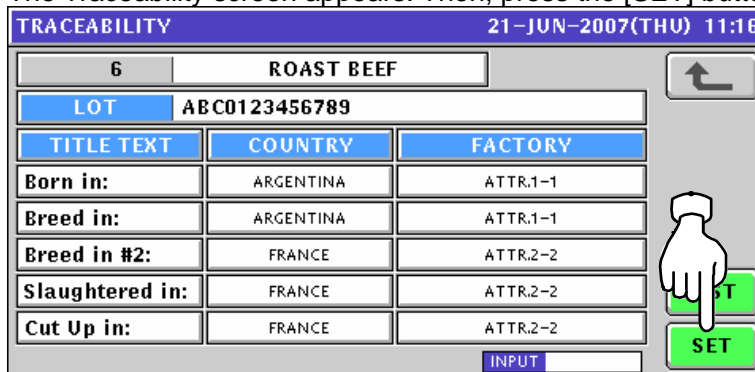

5. The selected PLU screen appears.

Weighing Unit Price Products

PLU 6 21-JUN-2007(THU) 11:15					TARE kg
ROAST BEEF					0.000
					ZERO WEIGHT kg
					0.000
U/P	F/P	FIX UPR	FIX UPR +WEIGHT	COUPONMS	UNIT PRICE £/kg
SPECIAL	-\$	-%	SP. (U/P)	-\$ (U/P)	4.00
0.00	0.00	0.0	0.00	0.00	
-(U/P)	P DATE	S DATE	TOTALADD	PRN QTY	TOTAL PRICE £
0.0	21-06-07	27-06-07	<ADD>	0	0.00
PRN MD.	PEEL MD.	CASSETTE	MULTI	FUNCTION GROUP	
<MANUAL>	<INDIV>	1			

Fixed Price Products

PLU 6 21-JUN-2007(THU) 11:15					PCS 1
ROAST BEEF					FIXED WEIGHT kg
U/P	F/P	FIX UPR	FIX UPR +WEIGHT	COUPONMS	FIXED PRICE £
SPECIAL	-\$	-%	SP. (U/P)	-\$ (U/P)	4.00
0.00	0.00	0.0	0.00	0.00	
-(U/P)	P DATE	S DATE	TOTALADD	PRN QTY	
0.0	21-06-07	27-06-07	<ADD>	0	
PRN MD.	PEEL MD.	CASSETTE	MULTI	FUNCTION GROUP	
<MANUAL>	<INDIV>	1			

Fixed Unit Price Products

PLU 6					21-JUN-2007(THU) 11:15		
 ROAST BEEF					FIXED WEIGHT kg		
U/P	F/P	FIX UPR	FIX UPR +WEIGHT	COUPONMS	FIXED U.PRI £/kg		
				0	4.00		
SPECIAL	-\$	-%	SP. (U/P)	-\$ (U/P)			
0.00	0.00	0.0	0.00	0.00			
-(U/P)	P DATE	S DATE	TOTALADD	PRN QTY	TOTAL PRICE £		
0.0	21-06-07	27-06-07	<ADD>	0	0.00		
PRN MD.	PEEL MD.	GASSETTE	MULTI	FUNCTION GROUP			
<MANUAL>	<INDIV>	1					

Weighing Fixed Price Products

PLU 6					21-JUN-2007(THU) 11:15		TARE kg
 ROAST BEEF					0.000		
U/P	F/P	FIX UPR	FIX UPR +WEIGHT	COUPONMS	ZERO WEIGHT kg		
				0	0.000		
SPECIAL	-\$	-%	SP. (U/P)	-\$ (U/P)			
0.00	0.00	0.0	0.00	0.00			
-(U/P)	P DATE	S DATE	TOTALADD	PRN QTY			
0.0	21-06-07	27-06-07	<ADD>	0	FIXED PRICE £		
PRN MD.	PEEL MD.	GASSETTE	MULTI	FUNCTION GROUP	4.00		
<MANUAL>	<INDIV>	1					

TEMPORARY CHANGE OPERATIONS

5.1 UNIT PRICE CHANGE

1. Ensure that the selected PLU screen is displayed.

Weighing Products

PLU 6 21-JUN-2007(THU) 11:15					TARE kg
					0.000
					ZERO WEIGHT kg
					0.000
U/P	F/P	FIX UPR	FIX UPR +WEIGHT	COUPONMS	UNIT PRICE £/kg
SPECIAL	-\$	-%	SP. (U/P)	-\$ (U/P)	4.00
0.00	0.00	0.0	0.00	0.00	
-%(U/P)	P DATE	S DATE	TOTALADD	PRN QTY	TOTAL PRICE £
0.0	21-06-07	27-06-07	<ADD>	0	0.00
PRN MD.	PEEL MD.	CASSETTE	MULTI	FUNCTION GROUP	
<MANUAL>	<INDIV>	1			

Fixed Unit Price Products

PLU 6 21-JUN-2007(THU) 11:15					FIXED WEIGHT kg
					
					FIXED U.PRI £/kg
					4.00
U/P	F/P	FIX UPR	FIX UPR +WEIGHT	COUPONMS	TOTAL PRICE £
SPECIAL	-\$	-%	SP. (U/P)	-\$ (U/P)	0.00
0.00	0.00	0.0	0.00	0.00	
-%(U/P)	P DATE	S DATE	TOTALADD	PRN QTY	
0.0	21-06-07	27-06-07	<ADD>	0	
PRN MD.	PEEL MD.	CASSETTE	MULTI	FUNCTION GROUP	
<MANUAL>	<INDIV>	1			

2. Enter a desired unit price using the numeric keys and press the "UNIT PRICE" or "FIXED UNIT PRICE" field.



EXAMPLE "\$3.80"



Weighing Products

PLU 6 21-JUN-2007(THU) 11:15					TARE kg
					0.000
					ZERO WEIGHT kg
					0.000
U/P	F/P	FIX UPR	FIX UPR +WEIGHT	COUPONMS	UNIT PRICE £/kg
SPECIAL	-\$	-%	SP. (U/P)	-\$ (U/P)	3.80
0.00	0.00	0.0	0.00	0.00	
-%(U/P)	P DATE	S DATE	TOTALADD	PRN QTY	TOTAL PRICE £
0.0	21-06-07	27-06-07	<ADD>	0	0.00
PRN MD.	PEEL MD.	CASSETTE	MULTI	FUNCTION GROUP	
<MANUAL>	<INDIV>	1			

Fixed Unit Price Products

PLU 6					21-JUN-2007(THU) 11:15		
   ROAST BEEF					FIXED WEIGHT kg		
					FIXED U.PRI £/kg		
U/P	F/P	FIX UPR	FIX UPR +WEIGHT	COUPONMS	3.80		
SPECIAL	-\$	-%	SP. (U/P)	-\$ (U/P)	0.00		
0.00	0.00	0.0	0.00	0.00	0.00		
-(U/P)	P DATE	S DATE	TOTALADD	PRN QTY	0.00		
0.0	21-06-07	27-06-07	<ADD>	0	0.00		
PRN MD.	PEEL MD.	CASSETTE	MULTI	FUNCTION GROUP	0.00		
<MANUAL>	<INDIV>	1			0.00		



5.2 FIXED PRICE CHANGE

1. Ensure that the selected PLU screen is displayed.

Fixed Price Products

PLU 6 21-JUN-2007(THU) 11:15					PCS	1
ROAST BEEF					FIXED WEIGHT kg	
U/P	F/P	FIX UPR	FIX UPR +WEIGHT	COUPONMS		
SPECIAL	-\$	-%	SP. (U/P)	-\$ (U/P)		
0.00	0.00	0.0	0.00	0.00		
-(U/P)	P DATE	S DATE	TOTALADD	PRN QTY	FIXED PRICE £	
0.0	21-06-07	27-06-07	<ADD>	0	4.00	
PRN MD.	PEEL MD.	CASSETTE	MULTI	FUNCTION GROUP		
<MANUAL>	<INDIV>	1				

Weighing Fixed Price Products

PLU 6 21-JUN-2007(THU) 11:15					TARE	kg
ROAST BEEF					0.000	
U/P	F/P	FIX UPR	FIX UPR +WEIGHT	COUPONMS	ZERO	WEIGHT kg
SPECIAL	-\$	-%	SP. (U/P)	-\$ (U/P)	0.000	
0.00	0.00	0.0	0.00	0.00		
-(U/P)	P DATE	S DATE	TOTALADD	PRN QTY	FIXED PRICE £	
0.0	21-06-07	27-06-07	<ADD>	0	4.00	
PRN MD.	PEEL MD.	CASSETTE	MULTI	FUNCTION GROUP		
<MANUAL>	<INDIV>	1				

2. Enter a desired price using the numeric keys, and press the "FIXED PRICE" field.

EXAMPLE "\$3.80"







Fixed Price Products

PLU 6 21-JUN-2007(THU) 11:15					PCS	1
ROAST BEEF					FIXED WEIGHT kg	
U/P	F/P	FIX UPR	FIX UPR +WEIGHT	COUPONMS		
SPECIAL	-\$	-%	SP. (U/P)	-\$ (U/P)		
0.00	0.00	0.0	0.00	0.00		
-(U/P)	P DATE	S DATE	TOTALADD	PRN QTY	FIXED PRICE £	
0.0	21-06-07	27-06-07	<ADD>	0	3.80	
PRN MD.	PEEL MD.	CASSETTE	MULTI	FUNCTION GROUP		
<MANUAL>	<INDIV>	1				



Weighing Fixed Price Products

PLU 6					21-JUN-2007(THU) 11:15					TARE kg	
    ROAST BEEF					0.000					ZERO WEIGHT kg	
					0.000						
U/P	F/P	FIX UPR	FIX UPR +WEIGHT	COUPONMS							
SPECIAL	-\$	-%	SP. (U/P)	-\$ (U/P)							
0.00	0.00	0.0	0.00	0.00							
-% (U/P)	P DATE	S DATE	TOTALADD	PRN QTY							
0.0	21-06-07	27-06-07	<ADD>	0							
PRN MD.	PEEL MD.	CASSETTE	MULTI	FUNCTION GROUP	FIXED PRICE £						
<MANUAL>	<INDIV>	1			3.80						



5.3 AMOUNT DISCOUNT FOR UNIT PRICE

1. Ensure that the selected PLU screen is displayed.

Weighing Unit Price Products				
PLU 6 21-JUN-2007(THU) 11:15				
ROAST BEEF				
U/P	F/P	FIX UPR	FIX UPR +WEIGHT	COUPONMS
SPECIAL	-\$	-%	SP. (U/P)	-\$ (U/P)
0.00	0.00	0.0	0.00	0.00
-%(U/P)	P DATE	S DATE	TOTALADD	PRN QTY
0.0	21-06-07	27-06-07	<ADD>	0
PRN MD.	PEEL MD.	CASSETTE	MULTI	FUNCTION GROUP
<MANUAL>	<INDIV>	1		
TARE kg				
0.000				
ZERO WEIGHT kg				
0.000				
UNIT PRICE £/kg				
4.00				
TOTAL PRICE £				
0.00				

Fixed Unit Price Products				
PLU 6 21-JUN-2007(THU) 11:15				
ROAST BEEF				
U/P	F/P	FIX UPR	FIX UPR +WEIGHT	COUPONMS
SPECIAL	-\$	-%	SP. (U/P)	-\$ (U/P)
0.00	0.00	0.0	0.00	0.00
-%(U/P)	P DATE	S DATE	TOTALADD	PRN QTY
0.0	21-06-07	27-06-07	<ADD>	0
PRN MD.	PEEL MD.	CASSETTE	MULTI	FUNCTION GROUP
<MANUAL>	<INDIV>	1		
FIXED WEIGHT kg				
FIXED U.PRI £/kg				
4.00				
TOTAL PRICE £				
0.00				



2. Enter a desired discount amount using the numeric keys, and press the “-\$ (U/P)” field.

EXAMPLE Discount amount “\$1.00”.



Weighing Unit Price Products				
PLU 6 21-JUN-2007(THU) 11:15				
ROAST BEEF				
U/P	F/P	FIX UPR	FIX UPR +WEIGHT	COUPONMS
SPECIAL	-\$	-%	SP. (U/P)	-\$ (U/P)
0.00	0.00	0.0	0.00	1.00
-%(U/P)	P DATE	S DATE	TOTALADD	PRN QTY
0.0	21-06-07	27-06-07	<ADD>	0
PRN MD.	PEEL MD.	CASSETTE	MULTI	FUNCTION GROUP
<MANUAL>	<INDIV>	1		
TARE kg				
0.000				
ZERO WEIGHT kg				
0.000				
UNIT PRICE £/kg				
3.00				
TOTAL PRICE £				
0.00				

Fixed Unit Price Products

PLU 6					21-JUN-2007(THU) 11:15		
   ROAST BEEF					FIXED WEIGHT kg		
					FIXED U.PRI £/kg		
U/P	F/P	FIX UPR	FIX UPR +WEIGHT	COUPONMS	3.00		
SPECIAL	-\$	-%	SP. (U/P)	-\$ (U/P)	0.00		
0.00	0.00	0.0	0.00	1.00	0.00		
-(U/P)	P. DATE	S. DATE	TOTALADD	PRN O	TOTAL PRICE £		
0.0	21-06-07	27-06-07	<ADD>	0	0.00		
PRN MD.	PEEL MD.	CASSETTE	MULTI	FUNCTION GROUP			
<MANUAL>	<INDIV>	1					



5.4 PERCENT DISCOUNT FOR UNIT PRICE

1. Ensure that the selected PLU screen is displayed.

Weighing Unit Price Products				
PLU 6 21-JUN-2007(THU) 11:15				
ROAST BEEF				
U/P	F/P	FIX UPR	FIX UPR +WEIGHT	COUPONMS
SPECIAL	-\$	-%	SP. (U/P)	-\$ (U/P)
0.00	0.00	0.0	0.00	0.00
-%(U/P)	P DATE	S DATE	TOTALADD	PRN QTY
0.0	21-06-07	27-06-07	<ADD>	0
PRN MD.	PEEL MD.	CASSETTE	MULTI	FUNCTION GROUP
<MANUAL>	<INDIV>	1		
TARE kg				
0.000				
ZERO WEIGHT kg				
0.000				
UNIT PRICE £/kg				
4.00				
TOTAL PRICE £				
0.00				

Fixed Unit Price Products				
PLU 6 21-JUN-2007(THU) 11:15				
ROAST BEEF				
U/P	F/P	FIX UPR	FIX UPR +WEIGHT	COUPONMS
SPECIAL	-\$	-%	SP. (U/P)	-\$ (U/P)
0.00	0.00	0.0	0.00	0.00
-%(U/P)	P DATE	S DATE	TOTALADD	PRN QTY
0.0	21-06-07	27-06-07	<ADD>	0
PRN MD.	PEEL MD.	CASSETTE	MULTI	FUNCTION GROUP
<MANUAL>	<INDIV>	1		
FIXED WEIGHT kg				
FIXED U.PRI £/kg				
4.00				
TOTAL PRICE £				
0.00				

2. Enter a desired discount percentage using the numeric keys on the key sheet, and press the “-% (U/P)” field.



EXAMPLE Discount percentage “10%”.



Weighing Unit Price Products				
PLU 6 21-JUN-2007(THU) 11:15				
ROAST BEEF				
U/P	F/P	FIX UPR	FIX UPR +WEIGHT	COUPONMS
SPECIAL	-\$	-%	SP. (U/P)	-\$ (U/P)
0.00	0.00	0.0	0.00	0.00
-%(U/P)	P DATE	S DATE	TOTALADD	PRN QTY
10.0	21-06-07	27-06-07	<ADD>	0
PRN MD.	PEEL MD.	CASSETTE	MULTI	FUNCTION GROUP
<MANU	<INDIV>	1		
TARE kg				
0.000				
ZERO WEIGHT kg				
0.000				
UNIT PRICE £/kg				
3.60				
TOTAL PRICE £				
0.00				



Fixed Unit Price Products

PLU 6					21-JUN-2007(THU) 11:15				
   ROAST BEEF					FIXED WEIGHT kg				
					FIXED U.PRI £/kg				
U/P	F/P	FIX UPR	FIX UPR +WEIGHT	COUPONMS	0				
SPECIAL	-\$	-%	SP. (U/P)	-\$ (U/P)	3.60				
0.00	0.00	0.0	0.00	0.00					
-(U/P)	P. DATE	S. DATE	TOTALADD	PRN QTY	TOTAL PRICE £				
10.0	21-06-07	27-06-07	<ADD>	0	0.00				
PRN MD	REEL MD.	CASSETTE	MULTI	FUNCTION GROUP					
<MANL	INDIV>	1							



5.5 AMOUNT DISCOUNT FOR TOTAL PRICE

1. Ensure that the selected PLU screen is displayed.

Fixed Price Products

PLU 6 21-JUN-2007(THU) 11:15					PCS 1
ROAST BEEF					FIXED WEIGHT kg
U/P	F/P	FIX UPR	FIX UPR +WEIGHT	COUPONMS	
SPECIAL	-\$	-%	SP. (U/P)	-\$ (U/P)	
0.00	0.00	0.0	0.00	0.00	
-%(U/P)	P DATE	S DATE	TOTALADD	PRN QTY	FIXED PRICE £
0.0	21-06-07	27-06-07	<ADD>	0	4.00
PRN MD.	PEEL MD.	CASSETTE	MULTI	FUNCTION GROUP	
<MANUAL>	<INDIV>	1			

Weighing Fixed Price Products

PLU 6 21-JUN-2007(THU) 11:15					TARE kg
ROAST BEEF					0.000
					ZERO WEIGHT kg
					0.000
U/P	F/P	FIX UPR	FIX UPR +WEIGHT	COUPONMS	
SPECIAL	-\$	-%	SP. (U/P)	-\$ (U/P)	
0.00	0.00	0.0	0.00	0.00	
-%(U/P)	P DATE	S DATE	TOTALADD	PRN QTY	
0.0	21-06-07	27-06-07	<ADD>	0	FIXED PRICE £
PRN MD.	PEEL MD.	CASSETTE	MULTI	FUNCTION GROUP	4.00
<MANUAL>	<INDIV>	1			

2. Enter a desired discount amount using the numeric keys, and press the “-\$” field.



EXAMPLE Discount amount “\$1.00”.



Fixed Price Products

PLU 6 21-JUN-2007(THU) 11:15					PCS 1
ROAST BEEF					FIXED WEIGHT kg
U/P	F/P	FIX UPR	FIX UPR +WEIGHT	COUPONMS	
SPECIAL	-\$	-%	SP. (U/P)	-\$ (U/P)	
0.00	1.00	0.0	0.00	0.00	
-%(U/P)	P DATE	S DATE	TOTALADD	PRN QTY	FIXED PRICE £
0.0	21-06-07	-06-07	<ADD>	0	3.00
PRN MD.	PEEL MD.	CASSETTE	MULTI	FUNCTION GROUP	
<MANUAL>	<INDIV>	1			

Weighing Fixed Price Products

PLU 6					21-JUN-2007(THU) 11:15		TARE	kg
   ROAST BEEF					0.000		ZERO	WEIGHT kg
					0.000			
U/P	F/P	FIX UPR	FIX UPR +WEIGHT	COUPONMS				
SPECIAL	-\$	-%	SP. (U/P)	-\$ (U/P)				
0.00	1.00	0.0	0.00	0.00				
-% (U/P)	P. DATE	S. DATE	TOTALADD	PRN QTY				
0.0	21-06	-06-07	<ADD>	0				
PRN MD.	PEEL MD.	CASSETTE	MULTI	FUNCTION GROUP	FIXED PRICE		£	
<MANUAL>	<INDIV	1			3.00			

5.6 PERCENT DISCOUNT FOR TOTAL PRICE

1. Ensure that the selected PLU screen is displayed.

Fixed Price Products

PLU 6 21-JUN-2007(THU) 11:15					PCS	1
ROAST BEEF					FIXED WEIGHT kg	
U/P	F/P	FIX UPR	FIX UPR +WEIGHT	COUPONMS		
SPECIAL	-\$	-%	SP. (U/P)	-\$ (U/P)		
0.00	0.00	0.0	0.00	0.00		
-%(U/P)	P DATE	S DATE	TOTALADD	PRN QTY	FIXED PRICE £	
0.0	21-06-07	27-06-07	<ADD>	0	4.00	
PRN MD.	PEEL MD.	CASSETTE	MULTI	FUNCTION GROUP		
<MANUAL>	<INDIV>	1				

Weighing Fixed Price Products

PLU 6 21-JUN-2007(THU) 11:15					TARE	kg
ROAST BEEF					0.000	
					ZERO	WEIGHT kg
					0.000	
					FIXED PRICE £	
					4.00	



2. Enter a desired discount percentage using the numeric keys on the key sheet, and press the “-%” field.

EXAMPLE Discount percentage “10%”.



PLU 6 21-JUN-2007(THU) 11:15					PCS	1
ROAST BEEF					FIXED WEIGHT kg	
U/P	F/P	FIX UPR	FIX UPR +WEIGHT	COUPONMS		
SPECIAL	-\$	-%	SP. (U/P)	-\$ (U/P)		
0.00	0.00	10.0	0.00	0.00		
-%(U/P)	P DATE	S DATE	TOTALADD	PRN QTY	FIXED PRICE £	
0.0	21-06-07	27-06-07	<ADD>	0	3.60	
PRN MD.	PEEL MD.	CASSETTE	MULTI	FUNCTION GROUP		
<MANUAL>	<INDIV>	1				

Weighing Fixed Price Products

PLU 6					21-JUN-2007(THU) 11:15		TARE kg	
   ROAST BEEF					0.000		ZERO WEIGHT kg	
					0.000			
U/P	F/P	FIX UPR	FIX UPR +WEIGHT	COUPONMS				
SPECIAL	-\$	-%	SP. (U/P)	-\$ (U/P)				
0.00	0.00	10.0	0.00	0.00				
-%(U/P)	P DATE	S DATE	TOTALADD	PRN QTY				
0.0	21-06-07	27-06	<ADD>	0		FIXED PRICE £		
PRN MD.	PEEL MD.	CASSET	MULTI	FUNCTION GROUP		3.60		
<MANUAL>	<INDIV>	1						

5.7 PRODUCT QUANTITY CHANGE

1. Ensure that the selected PLU screen is displayed.

Fixed Price Products

PLU 6 21-JUN-2007(THU) 11:15					PCS	1
ROAST BEEF					FIXED WEIGHT kg	
U/P	F/P	FIX UPR	FIX UPR +WEIGHT	COUPONMS		
SPECIAL	-\$	-%	SP. (U/P)	-\$ (U/P)		
0.00	0.00	0.0	0.00	0.00		
-%(U/P)	P DATE	S DATE	TOTALADD	PRN QTY	FIXED PRICE £	
0.0	21-06-07	27-06-07	<ADD>	0	4.00	
PRN MD.	PEEL MD.	CASSETTE	MULTI	FUNCTION GROUP		
<MANUAL>	<INDIV>	1				

2. Enter a desired quantity using the numeric keys, and press the "PCS" field.

EXAMPLE Quantity "2 pieces"

2

PLU 6 21-JUN-2007(THU) 11:15					PCS	2
ROAST BEEF					FIXED WEIGHT kg	
U/P	F/P	FIX UPR	FIX UPR +WEIGHT	COUPONMS		
SPECIAL	-\$	-%	SP. (U/P)	-\$ (U/P)		
0.00	0.00	0.0	0.00	0.00		
-%(U/P)	P DATE	S DATE	TOTALADD	PRN QTY	FIXED PRICE £	
0.0	21-06-07	27-06-07	<ADD>	0	4.00	
PRN MD.	PEEL MD.	CASSETTE	MULTI	FUNCTION GROUP		
<MANUAL>	<INDIV>	1				

3. To select a desired fix price mark, press the "PCS" field again.

PLU 6 21-JUN-2007(THU) 11:15					PCS	2
ROAST BEEF					FIXED WEIGHT kg	
U/P	F/P	FIX UPR	FIX UPR +WEIGHT	COUPONMS		
SPECIAL	-\$	-%	SP. (U/P)	-\$ (U/P)		
0.00	0.00	0.0	0.00	0.00		
-%(U/P)	P DATE	S DATE	TOTALADD	PRN QTY	FIXED PRICE £	
0.0	21-06-07	27-06-07	<ADD>	0	4.00	
PRN MD.	PEEL MD.	CASSETTE	MULTI	FUNCTION GROUP		
<MANUAL>	<INDIV>	1				

- The Fix Price mark List screen appears. Then, select a desired mark by pressing the corresponding field.

EXAMPLE Price mark "PC. PCS."

FIX PRICE MARK LIST		21-JUN-2007(THU) 11:15	1/3
0	NONE		↑
1	oz oz		
2	lb lb		
3	kg kg		↓
4	g g		
5	PC. PCS.		

FIND PLU SEARCH INPUT



PLU 6					21-JUN-2007(THU) 11:15		PCS	2PCS.
ROAST BEEF					FIXED WEIGHT		kg	
U/P	F/P	FIX UPR	FIX UPR +WEIGHT	COUPONMS				
SPECIAL	-\$	-%	SP. (U/P)	-\$ (U/P)				
0.00	0.00	0.0	0.00	0.00				
-% (U/P)	P DATE	S DATE	TOTALADD	PRN QTY	FIXED PRICE		£	
0.0	21-06-07	27-06-07	<ADD>	0	4.00			
PRN MD.	PEEL MD.	CASSETTE	MULTI	FUNCTION GROUP				
<MANUAL>	<INDIV>	1						

5.8 PRINT QUANTITY SETTING

1. Ensure that the selected PLU screen is displayed and “AUTO” is selected in the Printing Mode.

Fixed Price Products						
PLU 6		21-JUN-2007(THU) 11:15			PCS	1
ROAST BEEF					FIXED WEIGHT	kg
U/P	F/P	FIX UPR	FIX UPR +WEIGHT	COUPONMS		
				0		
SPECIAL	-\$	-%	SP. (U/P)	-\$ (U/P)		
0.00	0.00	0.0	0.00	0.00		
-%(U/P)	P DATE	S DATE	TOTALADD	PRN QTY	FIXED PRICE £	
0.0	21-06-07	27-06-07	<ADD>	0	4.00	
PRN MD.	PEEL MD.	CASSETTE	MULTI	FUNCTION GROUP		
<AUTO>	<INDIV>	1				

2. Enter a desired number of labels and press the “PRN QTY (Print Quantity)” field on the screen.

EXAMPLE Print quantity “3”.

3

Fixed Price Products						
PLU 6		21-JUN-2007(THU) 11:15			PCS	1
ROAST BEEF					FIXED WEIGHT	kg
U/P	F/P	FIX UPR	FIX UPR +WEIGHT	COUPONMS		
				0		
SPECIAL	-\$	-%	SP. (U/P)	-\$ (U/P)		
0.00	0.00	0.0	0.00	0.00		
-%(U/P)	P DATE	S DATE	TOTALADD	PRN QTY	FIXED PRICE £	
0.0	21-06-07	27-06-07	<ADD>	3	4.00	
PRN MD.	PEEL MD.	CASSETTE	MULTI	FUNCTION GROUP		
<AUTO>	<INDIV>	1				

3. Press the [PRINT] key on the key sheet.

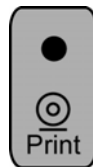

The set number of labels will be issued.



Note: To interrupt the issue of labels, press the [PRINT] key again.
To continue the issue of labels, press the [PRINT] key again.

SELF-SERVICE OPERATIONS

6.1 WEIGHING PRODUCTS

1. Ensure that the initial screen is displayed.



2. Select a desired product by pressing the corresponding button on the screen.

EXAMPLE Select "Roast Beef"



3. The selected product screen appears.

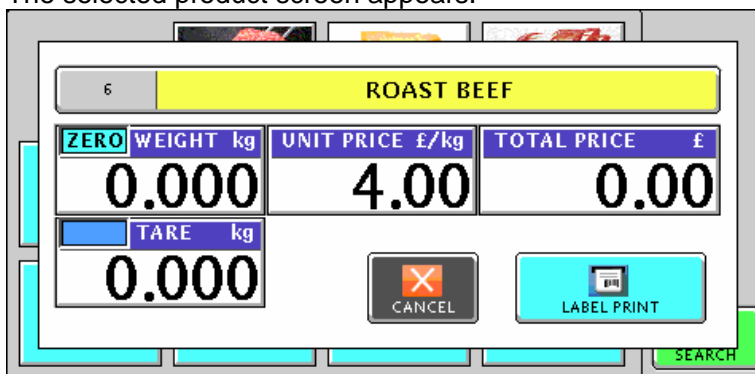

4. Put a product on the weigh platter.



The weight is measured and the total price is calculated.

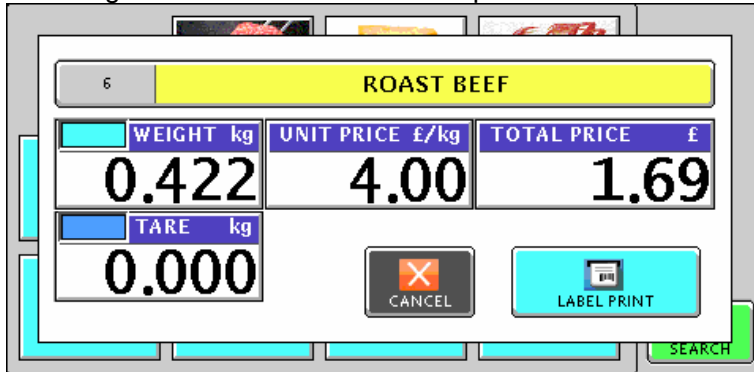

5. Press the [LABEL PRINT] button on the screen to issue the label.

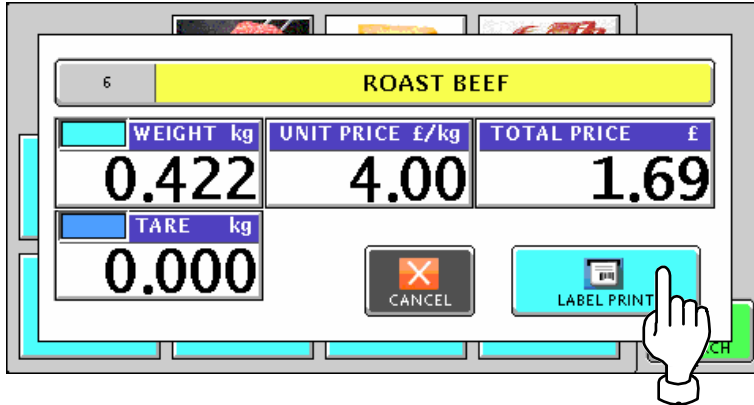

The label is issued.



6.2 FIXED PRICE PRODUCTS

1. Ensure that the initial screen is displayed.



2. Select a desired product by pressing the corresponding button on the screen.

EXAMPLE Select "Roast Beef"



3. The selected product screen appears.
Then, press the [LABEL PRINT] button on the screen to issue the label.

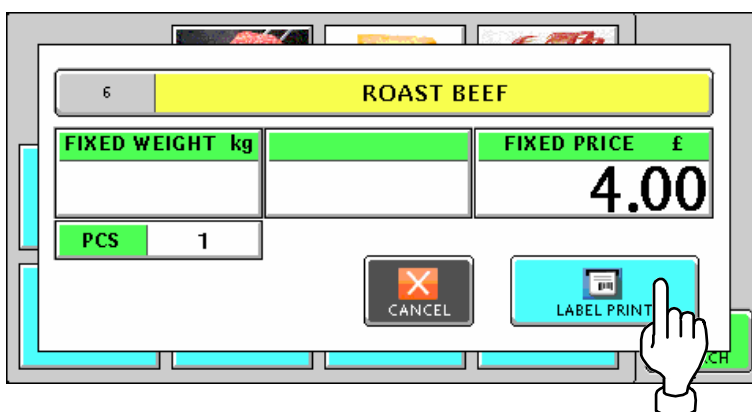

The label is issued.



ACCUMULATOR MODE

7.1 MANUAL INPUT ACCUMULATION

- To get the Operation Menu Select screen, press the [MODE] key on the key sheet.

Mode

Then, press the "ACC (Accumulator)" filed.



- The Accumulator (Input Number Accumulation) screen appears.

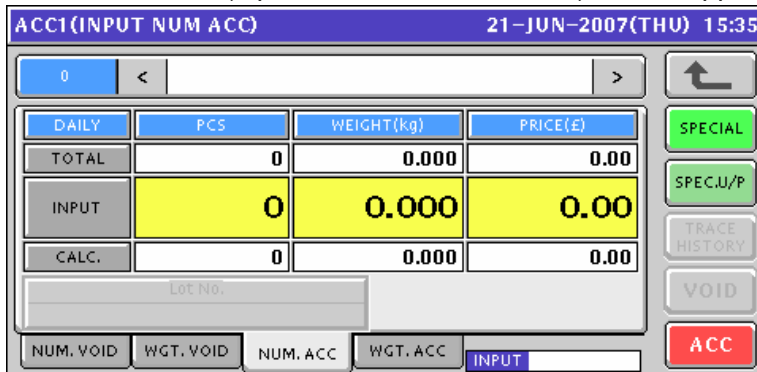

- Enter a desired PLU number and press the [PLU] key on the key sheet.

EXAMPLE PLU number "6".



The Input Number Accumulation screen for the selected product appears.

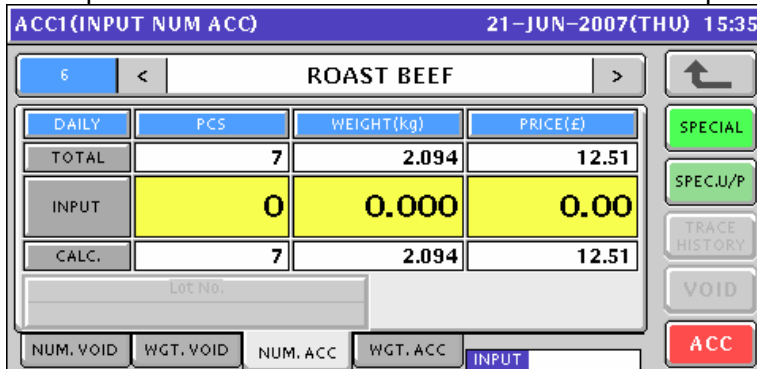

4. Enter a quantity, weight, and price that are to be accumulated and press the corresponding fields for registration. Then, press the [ACC] button on the screen.

EXAMPLE Quantity "1 pc.", Weight "169g", Price "\$0.84"

DAILY	PCS	WEIGHT(kg)	PRICE(£)
TOTAL	7	2.094	12.51
INPUT	1	0.169	0.84
CALC.	8	2.263	13.35

Buttons: NUM. VOID, WGT. VOID, NUM. ACC, WGT. ACC, INPUT, ACC

5. The confirmation screen appears. Then, press the [EXEC] button on the screen.

11006 - 0000

Buttons: EXEC, STOP

6. The registration has been completed.

DAILY	PCS	WEIGHT(kg)	PRICE(£)
TOTAL	8	2.263	13.35
INPUT	0	0.000	0.00
CALC.	8	2.263	13.35

Buttons: NUM. VOID, WGT. VOID, NUM. ACC, WGT. ACC, INPUT, ACC

7.2 WEIGHING ACCUMULATION

- To get the Operation Menu Select screen, press the [MODE] key on the key sheet.

Mode

Then, press the “ACC (Accumulator)” filed.

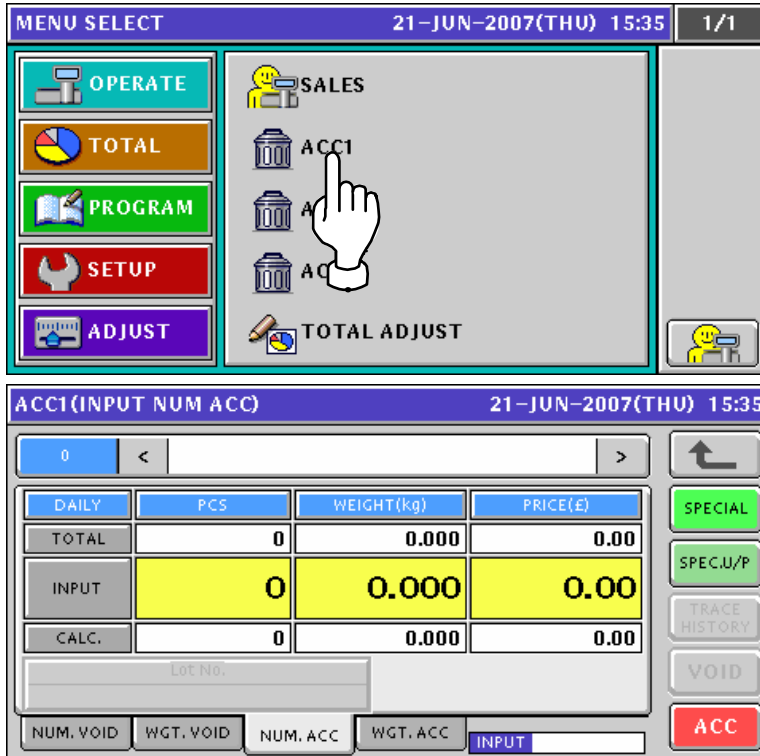

MENU SELECT 21-JUN-2007(THU) 15:35 1/1

OPERATE	SALES
TOTAL	ACC1
PROGRAM	ACC
SETUP	ACC
ADJUST	TOTAL ADJUST

ACC1(INPUT NUM ACC) 21-JUN-2007(THU) 15:35

0	<	>	
DAILY	PCS	WEIGHT(kg)	PRICE(£)
TOTAL	0	0.000	0.00
INPUT	0	0.000	0.00
CALC.	0	0.000	0.00

Lot No.

NUM. VOID WGT. VOID NUM. ACC WGT. ACC INPUT

SPECIAL SPEC.U/P TRACE HISTORY VOID ACC

- To get the Weighing Accumulation screen, press the [WGT. ACC] tab.

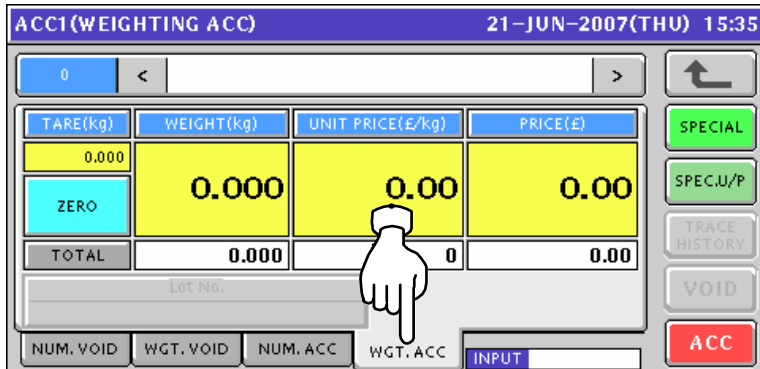

ACC1(WEIGHTING ACC) 21-JUN-2007(THU) 15:35

0	<	>	
TARE(kg)	WEIGHT(kg)	UNIT PRICE(£/kg)	PRICE(£)
0.000	0.000	0.00	0.00
ZERO			
TOTAL	0.000	0	0.00

Lot No.

NUM. VOID WGT. VOID NUM. ACC WGT. ACC INPUT

SPECIAL SPEC.U/P TRACE HISTORY VOID ACC

3. Enter a desired PLU number and press the [PLU] key on the key sheet.

EXAMPLE PLU number "6".



The Weighing Accumulation screen for the selected product appears.

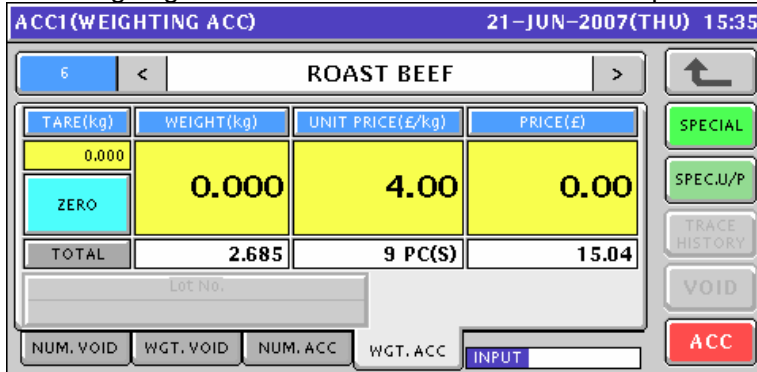

4. Put a product on the weigh platter and press the [ACC] button on the screen..

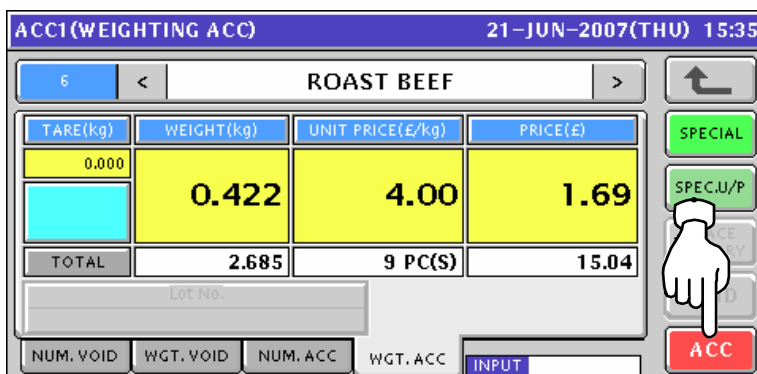

5. The confirmation screen appears. Then, press the [EXEC] button on the screen.

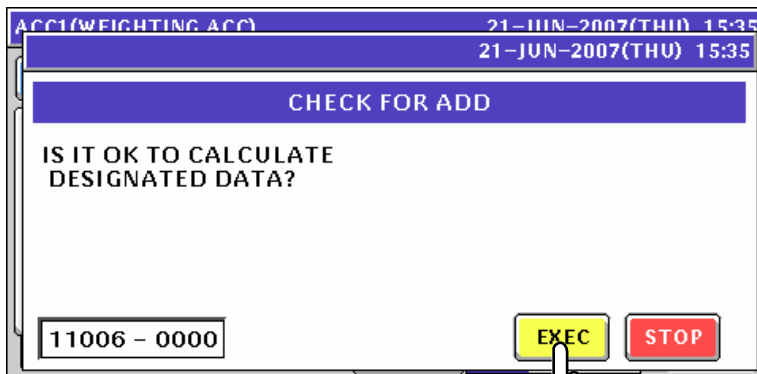

6. Remove the product from the weigh platter.

PRODUCT

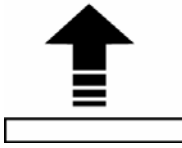

ACCI(WEIGHTING ACC)				21-JUN-2007(THU) 15:36	
6	<	ROAST BEEF		>	
TARE(kg)	WEIGHT(kg)	UNIT PRICE(£/kg)	PRICE(£)	SPECIAL	
0.000	0.000	4.00	0.00	SPEC.U/P	
ZERO				TRACE HISTORY	
TOTAL	3.107	10 PC(S)	16.73	VOID	
Lot No.					
NUM. VOID	WGT. VOID	NUM. ACC	WGT. ACC	INPUT	ACC

7.3 MANUAL INPUT VOID

- To get the Operation Menu Select screen, press the [MODE] key on the key sheet.

Mode

Then, press the “ACC (Accumulator)” filed.

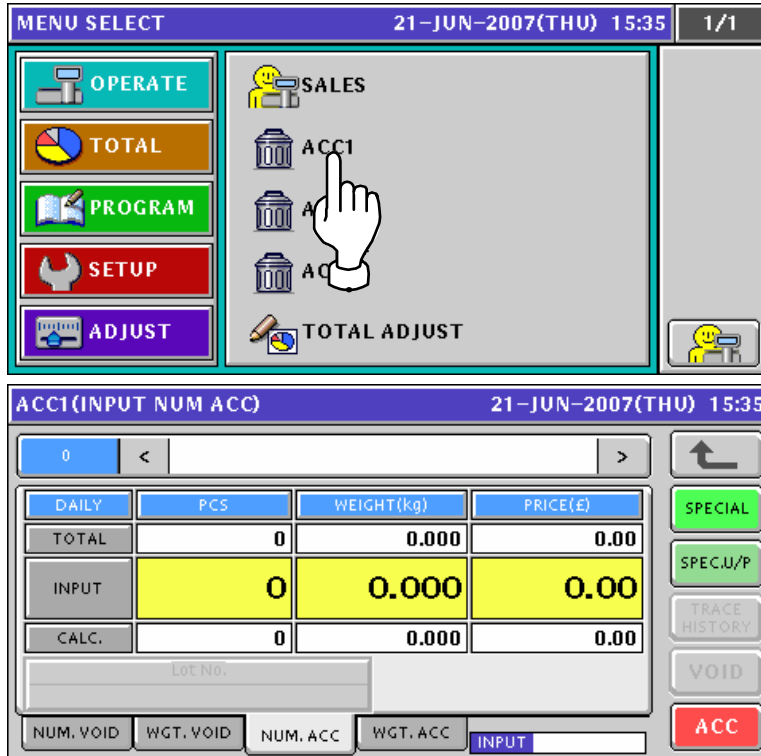

MENU SELECT 21-JUN-2007(THU) 15:35 1/1

OPERATE	SALES
TOTAL	ACC1
PROGRAM	ACC
SETUP	ACC
ADJUST	TOTAL ADJUST

ACC1(INPUT NUM ACC) 21-JUN-2007(THU) 15:35

0	<	>	
DAILY	PCS	WEIGHT(kg)	PRICE(£)
TOTAL	0	0.000	0.00
INPUT	0	0.000	0.00
CALC.	0	0.000	0.00

LOC NO.

NUM. VOID WGT. VOID NUM. ACC WGT. ACC INPUT

SPECIAL SPEC.U/P TRACE HISTORY VOID ACC

- To get the Input Number Void screen, press the [NUM. VOID] tab.

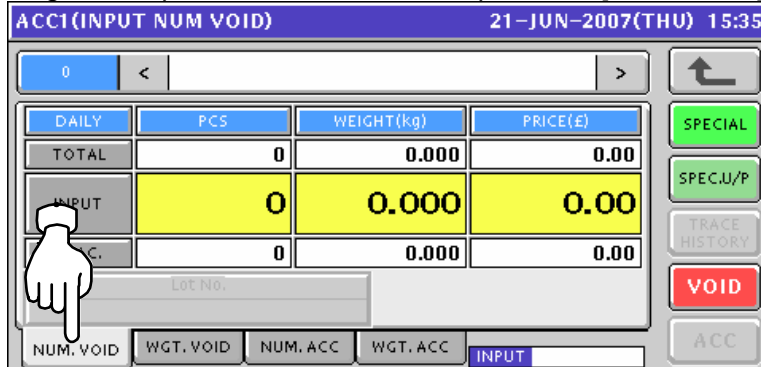

ACC1(INPUT NUM VOID) 21-JUN-2007(THU) 15:35

0	<	>	
DAILY	PCS	WEIGHT(kg)	PRICE(£)
TOTAL	0	0.000	0.00
INPUT	0	0.000	0.00
CALC.	0	0.000	0.00

LOC NO.

NUM. VOID WGT. VOID NUM. ACC WGT. ACC INPUT

SPECIAL SPEC.U/P TRACE HISTORY VOID ACC

3. Enter a desired PLU number and press the [PLU] key on the key sheet.

EXAMPLE PLU number "6".



The Input Number Void screen for the selected product appears.

ACCI(INPUT NUM VOID)				21-JUN-2007(THU) 15:35	
6	<	ROAST BEEF	>		
DAILY	PCS	WEIGHT(kg)	PRICE(£)	SPECIAL	
TOTAL	10	3.107	16.73	SPEC.U/P	
INPUT	0	0.000	0.00	TRACE HISTORY	
CALC.	10	3.107	16.73	VOID	
Lot No.					
NUM. VOID	WGT. VOID	NUM. ACC	WGT. ACC	INPUT	ACC

4. Enter a quantity, weight, and price that are to be voided and press the corresponding fields for registration. Then, press the [VOID] button on the screen.

EXAMPLE Quantity "1 pc.", Weight "169g", Price "\$0.84"

ACCI(INPUT NUM VOID)				21-JUN-2007(THU) 15:35	
6	<	ROAST BEEF	>		
DAILY	PCS	WEIGHT(kg)	PRICE(£)	SPECIAL	
TOTAL	10	3.107	16.73	SPEC.U/P	
INPUT	1	0.169	0.84	TRACE HISTORY	
CALC.	9	0.338	15.89	VOID	
Lot No.					
NUM. VOID	WGT. VOID	NUM. ACC	WGT. ACC	INPUT	ACC

5. The confirmation screen appears. Then, press the [EXEC] button on the screen.

ACCI(INPUT NUM VOID)		21-JUN-2007(THU) 15:35	
CHECK FOR SUBTRACTION			
IS IT OK TO CALCULATE DESIGNATED DATA?			
11005 - 0000		EXEC	STOP

6. The registration has been completed.

ACCI(INPUT NUM VOID)				21-JUN-2007(THU) 15:36	
6		ROAST BEEF		↶	
DAILY	PCS	WEIGHT(kg)	PRICE(£)	SPECIAL	
TOTAL	9	2.938	15.89	SPEC.U/P	
INPUT	0	0.000	0.00	TRACE HISTORY	
CALC.	9	2.938	15.89	VOID	
Lot No.					
NUM. VOID	WGT. VOID	NUM. ACC	WGT. ACC	INPUT	

7.4 WEIGHING VOID

- To get the Operation Menu Select screen, press the [MODE] key on the key sheet.

Mode

Then, press the “ACC (Accumulator)” filed.

ACC1 (INPUT NUM ACC) 21-JUN-2007(THU) 15:35

DAILY	PCS	WEIGHT(kg)	PRICE(£)
TOTAL	0	0.000	0.00
INPUT	0	0.000	0.00
CALC.	0	0.000	0.00

LOC NO.

NUM. VOID WGT. VOID NUM. ACC WGT. ACC INPUT

SPECIAL
SPEC.U/P
TRACE HISTORY
VOID
ACC

- To get the Weighing Void screen, press the [WGT. VOID] tab.

ACC1 (WEIGHING VOID) 21-JUN-2007(THU) 15:35

TARE(kg)	WEIGHT(kg)	UNIT PRICE(£/kg)	PRICE(£)
0.000	0.000	0.00	0.00
ZERO			
TOTAL	0.000	0	0.00

LOC NO.

NUM. VOID WGT. VOID NUM. ACC WGT. ACC INPUT

SPECIAL
SPEC.U/P
TRACE HISTORY
VOID
ACC

3. Enter a desired PLU number and press the [PLU] key on the key sheet.

EXAMPLE PLU number "6".



The Weighing Void screen for the selected product appears.

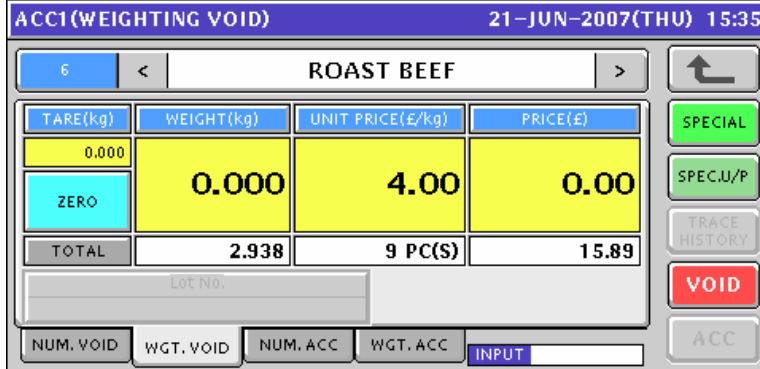

4. Put a product on the weigh platter and press the [VOID] button on the screen..

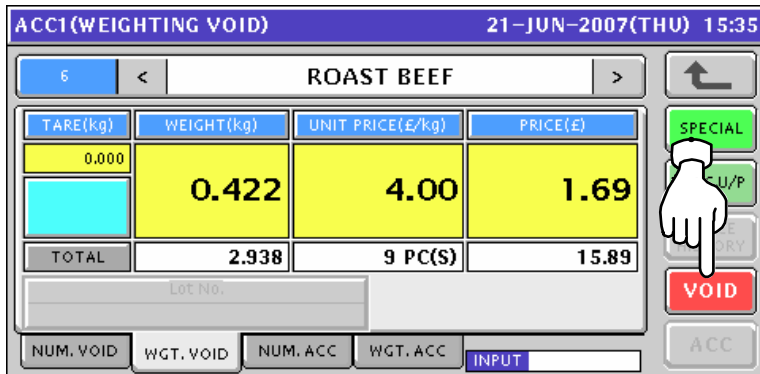

5. The confirmation screen appears. Then, press the [EXEC] button on the screen.

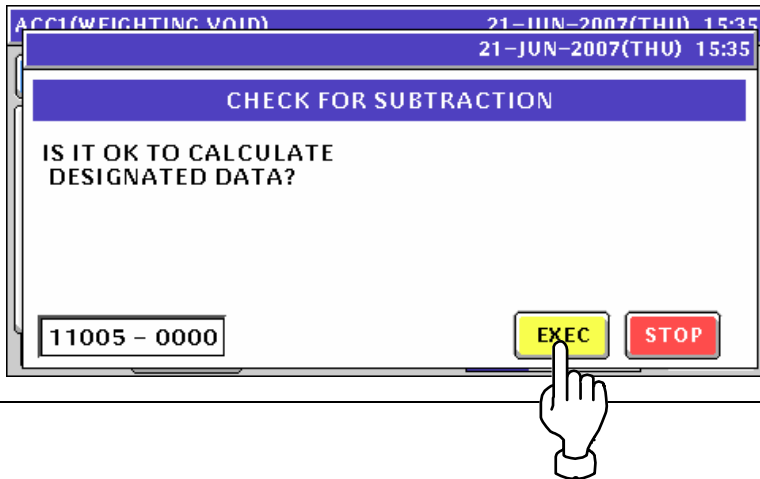

6. Remove the product from the weigh platter.



ACCI(WEIGHTING VOID)				21-JUN-2007(THU) 15:36	
6	<	ROAST BEEF		>	
TARE(kg)	WEIGHT(kg)	UNIT PRICE(£/kg)	PRICE(£)	SPECIAL	
0.000	0.000	4.00	0.00	SPEC.U/P	
ZERO				TRACE HISTORY	
TOTAL	2.516	8 PC(S)	14.20	VOID	
Lot No.					
NUM. VOID	WGT. VOID	NUM. ACC	WGT. ACC	INPUT	ACC

TOTAL ADJUST MODE

8.1 MANUAL INPUT SUBTRACTION

1. To get the Operation Menu Select screen, press the [MODE] key on the key sheet.

Mode

Then, press the "TOTAL ADJUST" filed.

DAILY	PCS	WEIGHT(kg)	PRICE(£)
TOTAL	0	0.000	0.00
INPUT	0	0.000	0.00
CALC.	0	0.000	0.00

2. Enter a desired PLU number and press the [PLU] key on the key sheet.

EXAMPLE PLU number "6".



The Total Adjust (Input Number Subtraction) screen for the selected product appears.

DAILY	PCS	WEIGHT(kg)	PRICE(£)
TOTAL	39	5.936	130.16
INPUT	0	0.000	0.00
CALC.	39	5.936	130.16

3. Enter a quantity, weight, and price that are to be subtracted and press the corresponding fields for registration. Then, press the [SUB] button on the screen.

EXAMPLE Quantity "1 pc.", Weight "169g", Price "\$0.84"

DAILY	PCS	WEIGHT(kg)	PRICE(£)
TOTAL	39	5.936	130.16
INPUT	1	0.169	0.84
CALC.	38	5.767	129.32

4. The confirmation screen appears. Then, press the [EXEC] button on the screen.

11006 - 0000

EXEC STOP

5. The registration has been completed.

DAILY	PCS	WEIGHT(kg)	PRICE(£)
TOTAL	38	5.767	129.32
INPUT	0	0.000	0.00
CALC.	38	5.767	129.32

8.2 WEIGHING SUBTRACTION

1. To get the Operation Menu Select screen, press the [MODE] key on the key sheet.

Mode

Then, press the "TOTAL ADJUST" filed.

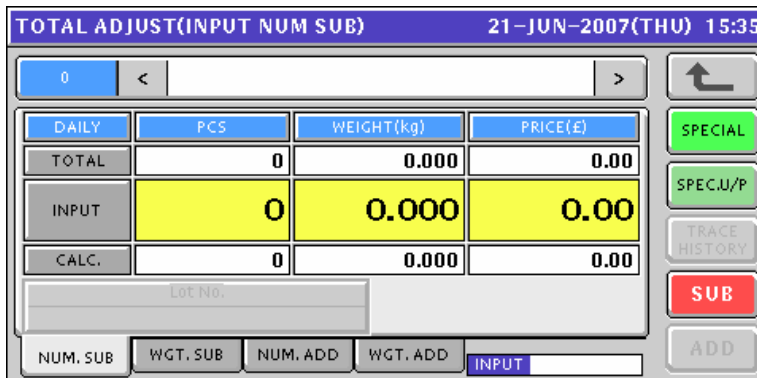
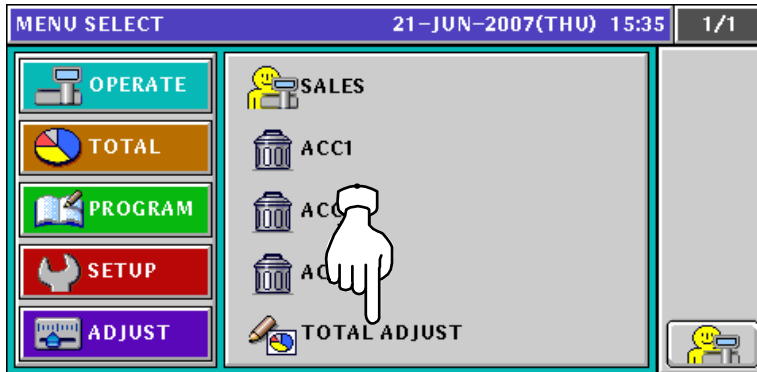

2. To get the Total Adjust (Weighing Subtraction) screen, press the [WGT. SUB] tab.

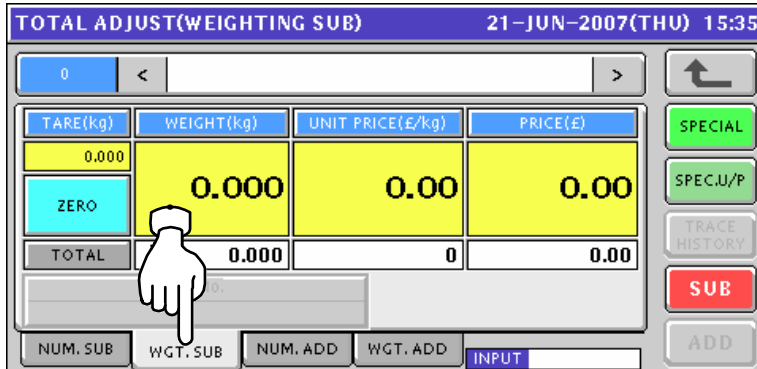

3. Enter a desired PLU number and press the [PLU] key on the key sheet.

EXAMPLE PLU number "6".



The Total Adjust (Weighing Subtraction) screen for the selected product appears.

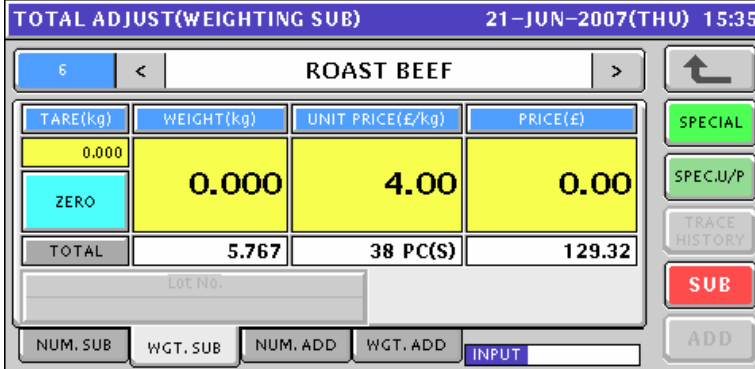

4. Put a product on the weigh platter and press the [SUB] button on the screen..

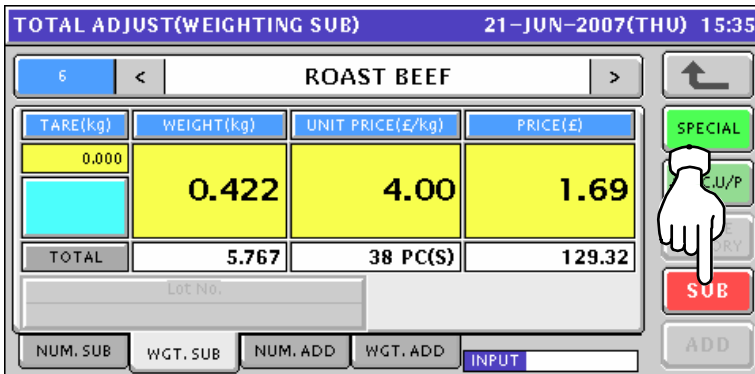

5. The confirmation screen appears. Then, press the [EXEC] button on the screen.

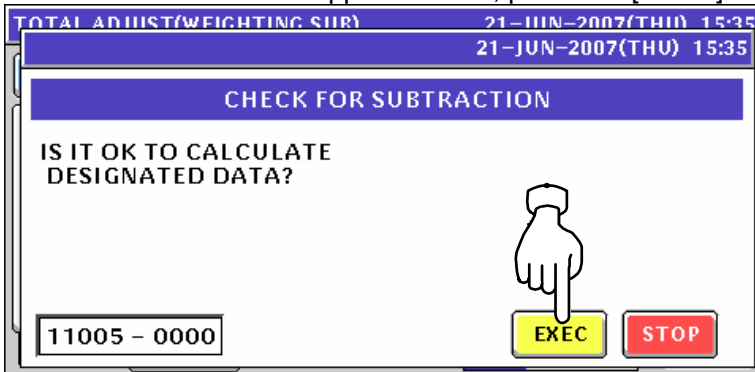

6. Remove the product from the weigh platter.

PRODUCT

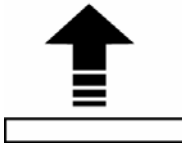

TOTAL ADJUST(WEIGHTING SUB)				21-JUN-2007(THU) 15:35	
6	<	ROAST BEEF		>	
TARE(kg)	WEIGHT(kg)	UNIT PRICE(£/kg)	PRICE(£)	SPECIAL	
0.000	0.000	4.00	0.00	SPEC.U/P	
ZERO				TRACE HISTORY	
TOTAL	5.345	37 PC(S)	127.63	SUB	
Lot No.					
NUM. SUB	WGT. SUB	NUM. ADD	WGT. ADD	INPUT	ADD

8.3 MANUAL INPUT ADDITION

- To get the Operation Menu Select screen, press the [MODE] key on the key sheet.

Mode

Then, press the "TOTAL ADJUST" filed.

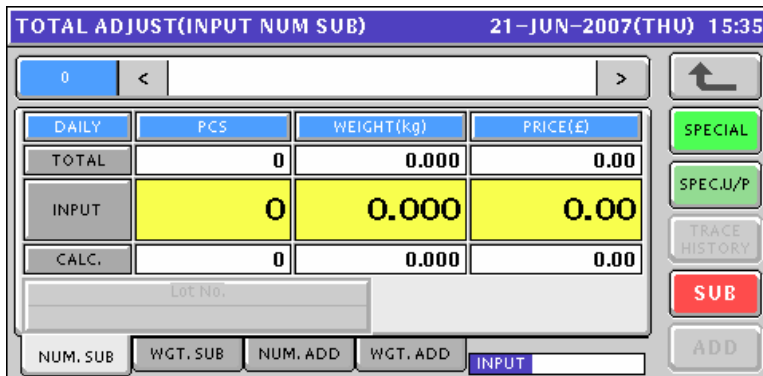
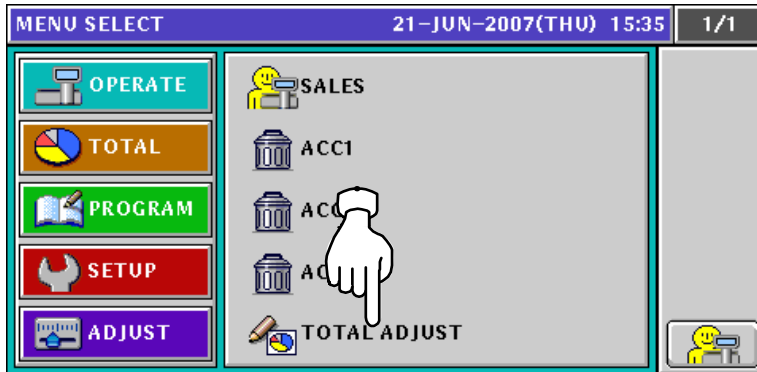

- To get the Total Adjust (Input Number Addition) screen, press the [NUM. ADD] tab.

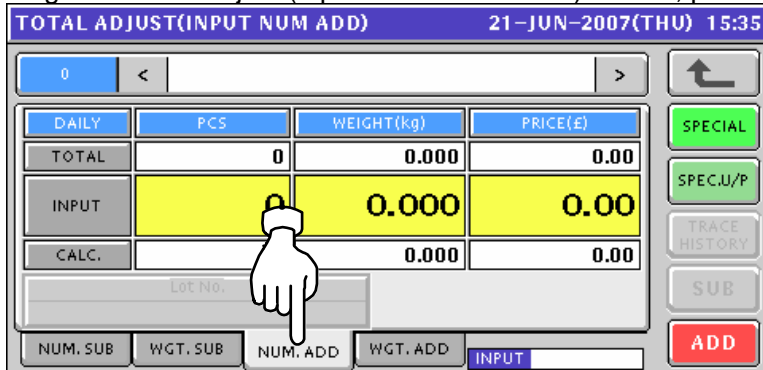

3. Enter a desired PLU number and press the [PLU] key on the key sheet.

EXAMPLE PLU number "6".



The Total Adjust (Input Number Addition) screen for the selected product appears.

TOTAL ADJUST(INPUT NUM ADD)				21-JUN-2007(THU) 15:35	
6	<	ROAST BEEF	>		
DAILY	PCS	WEIGHT(kg)	PRICE(£)	SPECIAL	
TOTAL	37	5.345	127.63	SPEC.U/P	
INPUT	0	0.000	0.00	TRACE HISTORY	
CALC.	37	5.345	127.63	SUB	
Lot No.					
NUM. SUB	WGT. SUB	NUM. ADD	WGT. ADD	INPUT	ADD

4. Enter a quantity, weight, and price that are to be added and press the corresponding fields for registration. Then, press the [ADD] button on the screen.

EXAMPLE Quantity "1 pc.", Weight "169g", Price "\$0.84"

TOTAL ADJUST(INPUT NUM ADD)				21-JUN-2007(THU) 15:35	
6	<	ROAST BEEF	>		
DAILY	PCS	WEIGHT(kg)	PRICE(£)	SPECIAL	
TOTAL	37	5.345	127.63	SPEC.U/P	
INPUT	1	0.169	0.84	TRACE HISTORY	
CALC.	38	5.514	128.47	SUB	
Lot No.					
NUM. SUB	WGT. SUB	NUM. ADD	WGT. ADD	INPUT	ADD

5. The confirmation screen appears. Then, press the [EXEC] button on the screen.

ACCI(INPUT NUM ACC)		21-JUN-2007(THU) 15:35	
21-JUN-2007(THU) 15:35			
CHECK FOR ADD			
IS IT OK TO CALCULATE DESIGNATED DATA?			
11006 - 0000			
		EXEC	STOP

6. The registration has been completed.

TOTAL ADJUST(INPUT NUM ADD)				21-JUN-2007(THU) 15:35	
6		ROAST BEEF			
DAILY	PCS	WEIGHT(kg)	PRICE(£)	SPECIAL	
TOTAL	38	5.514	128.47	SPEC.U/P	
INPUT	0	0.000	0.00	TRACE HISTORY	
CALC.	38	5.514	128.47	SUB	
Lot No.					
NUM. SUB	WGT. SUB	NUM. ADD	WGT. ADD	INPUT	ADD

8.4 WEIGHING ADDITION

1. To get the Operation Menu Select screen, press the [MODE] key on the key sheet.

Mode

Then, press the "TOTAL ADJUST" filed.

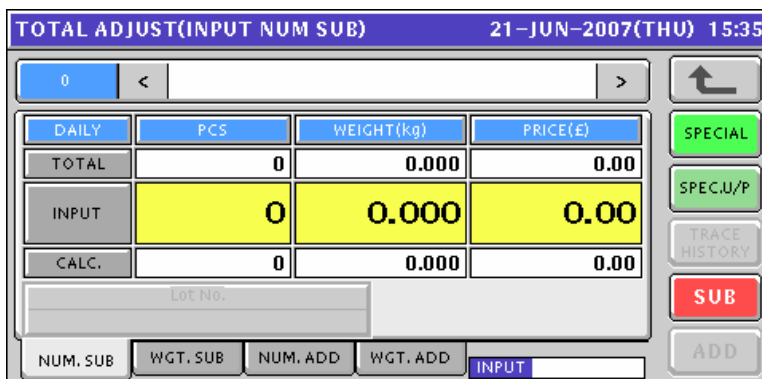
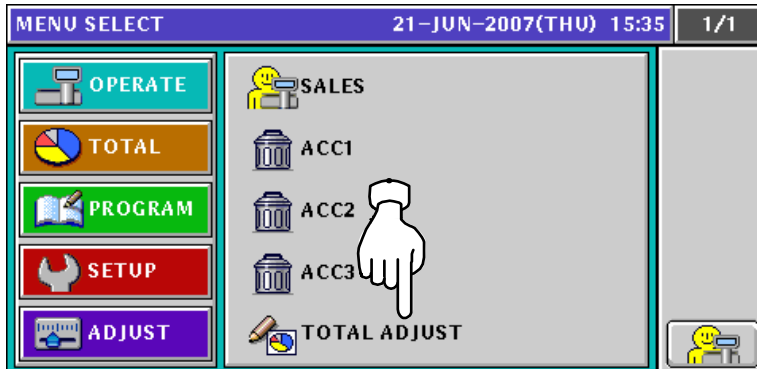

2. To get the Total Adjust (Weighing Add) screen, press the [WGT. ADD] tab.

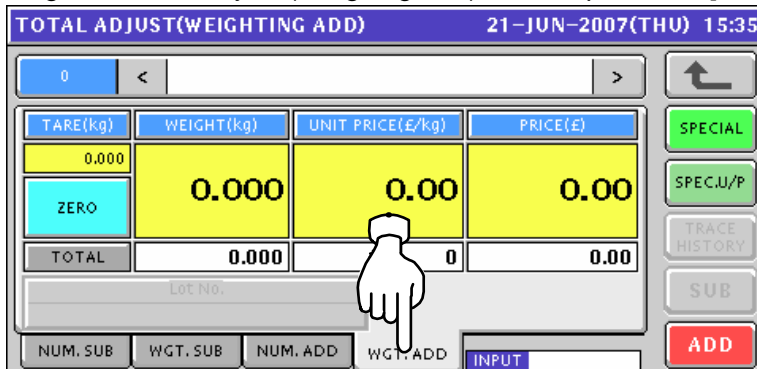

3. Enter a desired PLU number and press the [PLU] key on the key sheet.

EXAMPLE PLU number "6".



The Total Adjust (Weighing Add) screen for the selected product appears.

TOTAL ADJUST(WEIGHTING ADD)				21-JUN-2007(THU) 15:35	
6	<	ROAST BEEF	>		
TARE(kg)	WEIGHT(kg)	UNIT PRICE(£/kg)	PRICE(£)	SPECIAL	
0.000	0.000	4.00	0.00	SPEC.U/P	
ZERO				TRACE HISTORY	
TOTAL	5.514	38 PC(S)	128.47	SUB	
Lot No.					
NUM. SUB	WGT. SUB	NUM. ADD	WGT. ADD	INPUT	ADD

4. Put a product on the weigh platter and press the [ADD] button on the screen..



TOTAL ADJUST(WEIGHTING ADD)				21-JUN-2007(THU) 15:35	
6	<	ROAST BEEF	>		
TARE(kg)	WEIGHT(kg)	UNIT PRICE(£/kg)	PRICE(£)	SPECIAL	
0.000	0.422	4.00	1.69	SPEC.U/P	
				TRACE HISTORY	
TOTAL	5.514	38 PC(S)	128.47	SUB	
Lot No.					
NUM. SUB	WGT. SUB	NUM. ADD	WGT. ADD	INPUT	ADD

5. The confirmation screen appears. Then, press the [EXEC] button on the screen.

TOTAL ADJUST(WEIGHTING ADD)		21-JUN-2007(THU) 15:35	
CHECK FOR ADD			
IS IT OK TO CALCULATE DESIGNATED DATA?			
11006 - 0000			
		EXEC	STOP

6. Remove the product from the weigh platter.

PRODUCT

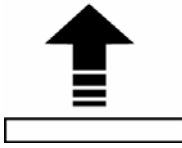

TOTAL ADJUST(WEIGHTING ADD)				21-JUN-2007(THU) 15:35	
6	<	ROAST BEEF	>	↶	
TARE(kg)	WEIGHT(kg)	UNIT PRICE(£/kg)	PRICE(£)	SPECIAL	
0.000	0.000	4.00	0.00	SPEC.U/P	
ZERO				TRACE HISTORY	
TOTAL	5.936	39 PC(S)	130.16	SUB	
Lot No.					
NUM. SUB	WGT. SUB	NUM. ADD	WGT. ADD	INPUT	ADD

TOTAL MODE

9.1 DAILY TOTAL

1. Press the "PRODUCTION DAILY TOTAL" filed.

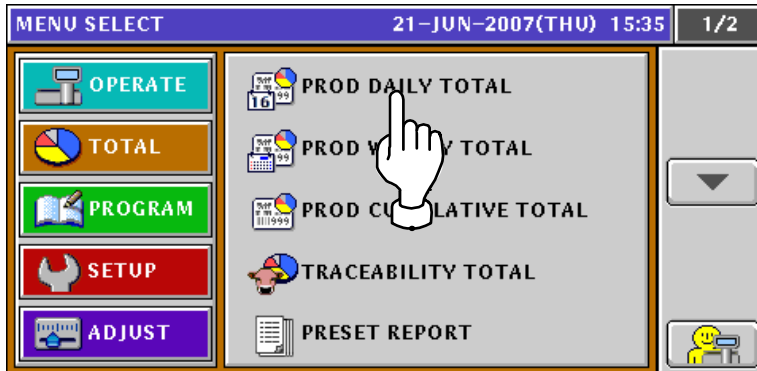

2. The Daily Total screen appears.

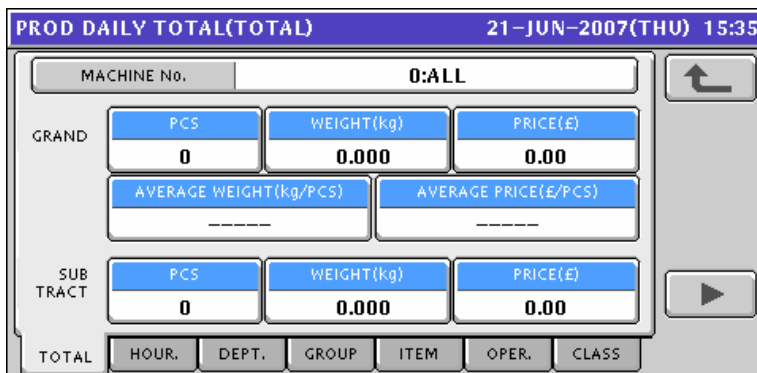

3. To obtain the Hourly Total screen, press the [HOUR.] tab.
To change the pages, press the [▼] or [▲] button on the screen.

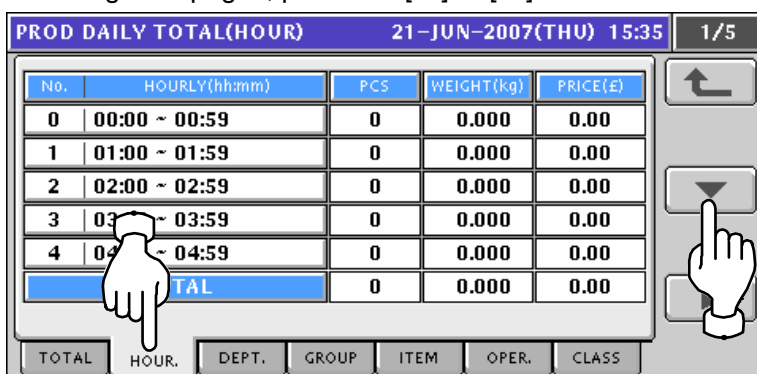

PROD DAILY TOTAL(HOUR)					21-JUN-2007(THU) 15:35	5/5
No.	HOURLY(hh:mm)	PCS	WEIGHT(kg)	PRICE(£)		
20	20:00 ~ 20:59	0	0.000	0.00		
21	21:00 ~ 21:59	0	0.000	0.00		
22	22:00 ~ 22:59	0	0.000	0.00		
23	23:00 ~ 23:59	0	0.000	0.00		
TOTAL		0	0.000	0.00		

TOTAL HOUR. DEPT. GROUP ITEM OPER. CLASS

4. To obtain the Department Total screen, press the [DEPT.] tab. To change the pages, press the [▼] or [▲] button on the screen.

PROD DAILY TOTAL(DEPT)					21-JUN-2007(THU) 15:35	1/1
No.	DEPARTMENT	PCS	WEIGHT(kg)	PRICE(£)		
TOTAL						

TOTAL HOUR. DEPT. GROUP ITEM OPER. CLASS

5. To obtain the Group Total screen, press the [GROUP] tab. To change the pages, press the [▼] or [▲] button on the screen.

PROD DAILY TOTAL(GROUP)					21-JUN-2007(THU) 15:35	1/1
No.	GROUP	PCS	WEIGHT(kg)	PRICE(£)		
TOTAL						

TOTAL HOUR. DEPT. GROUP ITEM OPER. CLASS

6. To obtain the Designated Item Total screen, press the [ITEM] tab.

PROD DAILY TOTAL(ITEM)					21-JUN-2007(THU) 15:35	
0						
PCS	WEIGHT(kg)	PRICE(£)				
0	0.000	0.00				

TOTAL HOUR. DEPT. GROUP ITEM OPER. CLASS

Enter a desired PLU number using the numeric keys and press the [PLU] key on the key sheet.

EXAMPLE PLU number "6".



PROD DAILY TOTAL(ITEM) 21-JUN-2007(THU) 15:35

6 ROAST BEEF

PCS	WEIGHT(kg)	PRICE(£)
7	2.954	11.83

TOTAL HOUR. DEPT. GROUP ITEM OPER. CLASS

7. To obtain the Operator Total screen, press the [ORER.] tab.

PROD DAILY TOTAL(OPER) 21-JUN-2007(THU) 15:35 1/1

No.	OPERATOR	PCS	WEIGHT(kg)	PRICE(£)
TOTAL		0		0.00

TOTAL HOUR. DEPT. GROUP ITEM OPER. CLASS

8. To obtain the Class Total screen, press the [CLASS] tab.

PROD DAILY TOTAL(CLASS) 21-JUN-2007(THU) 15:35

CLASS ANALYZE

NO	DEPT.	GROUP
✓		

CLASS

✓	PLU No.
	ABC PRICE
	ABC WEIGHT
	ABC PCS
	Z PRICE
	Z WEIGHT
	Z PCS

TOTAL HOUR. DEPT. GROUP ITEM OPER. CLASS ANALY SYS

NO	The object of analysis is not specified.
DEPT.	The object of analysis is specified to be departments.
GROUP	The object of analysis is specified to be groups.
PLU No.	Analysis is performed in ascending PLU number order.
ABC PRICE	Analysis is performed in descending price order.
ABC WEIGHT	Analysis is performed in descending weight order.
ABC PCS	Analysis is performed in descending quantity order.
Z PRICE	Analysis is performed in ascending price order.
Z WEIGHT	Analysis is performed in ascending weight order.
Z PCS	Analysis is performed in ascending quantity order.

9.2 WEEKLY TOTAL

1. Press the "PRODUCTION WEEKLY TOTAL" filed.

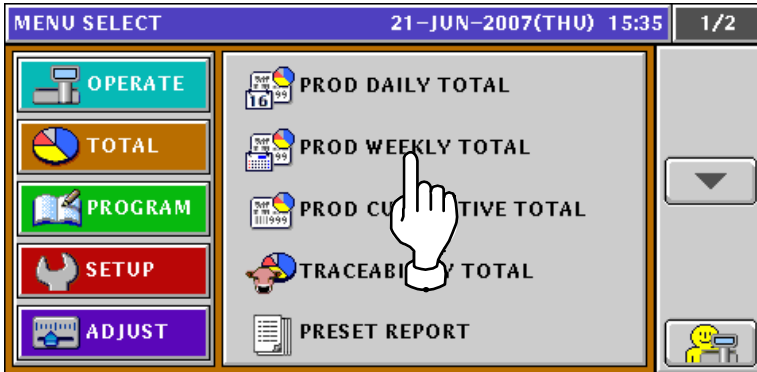

2. The Weekly Total screen appears.
To change the pages, press the [▼] or [▲] button on the screen.

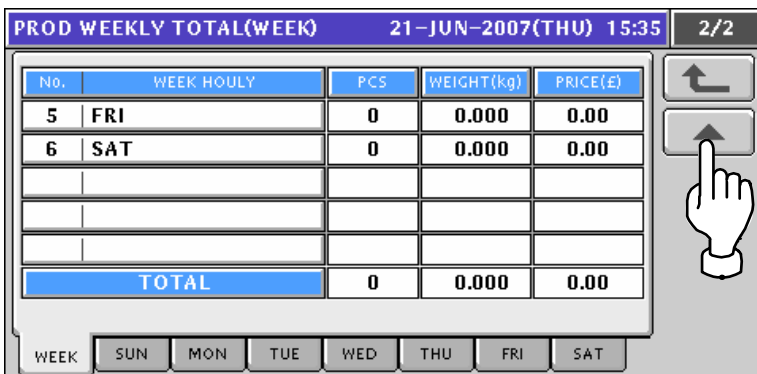
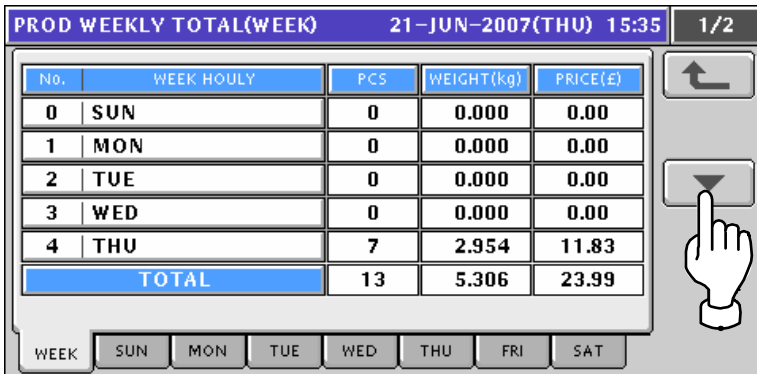

3. To obtain total for the day-of-the week, press a desired day-of-the week tab.
To change the pages, press the [▼] or [▲] button on the screen.

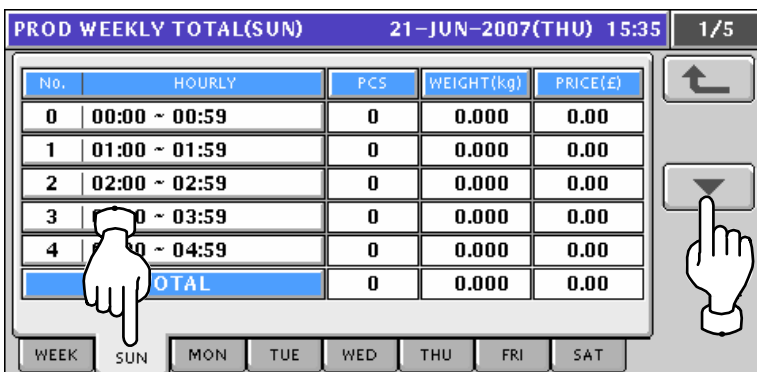

●
●
●

PROD WEEKLY TOTAL(SUN)		21-JUN-2007(THU) 15:35			5/5
No.	HOURLY	PCS	WEIGHT(kg)	PRICE(£)	
20	20:00 ~ 20:59	0	0.000	0.00	
21	21:00 ~ 21:59	0	0.000	0.00	
22	22:00 ~ 22:59	0	0.000	0.00	
23	23:00 ~ 23:59	0	0.000	0.00	
TOTAL		0	0.000	0.00	

WEEK SUN MON TUE WED THU FRI SAT

9.3 CUMULATIVE TOTAL

1. Press the "PRODUCTION CUMULATIVE TOTAL" filed.

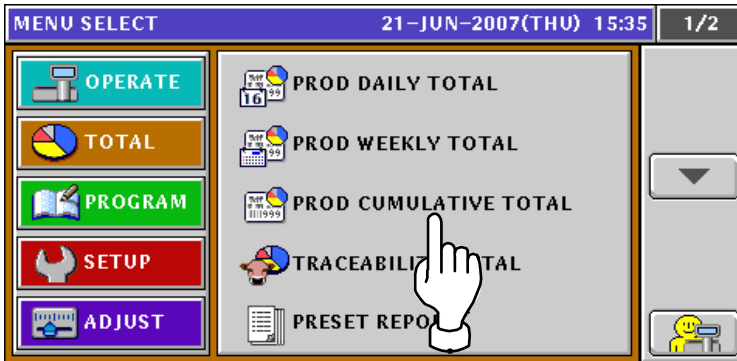

2. The Cumulative Total screen appears.

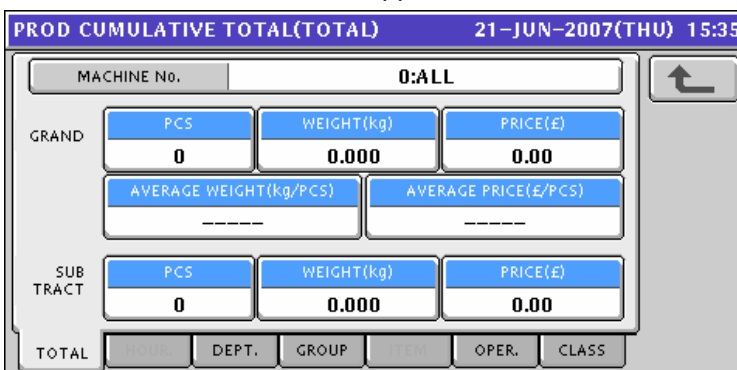

3. To obtain total for each department, press the [DEPT.] tab on the screen. To change the pages, press the [▼] or [▲] button on the screen.

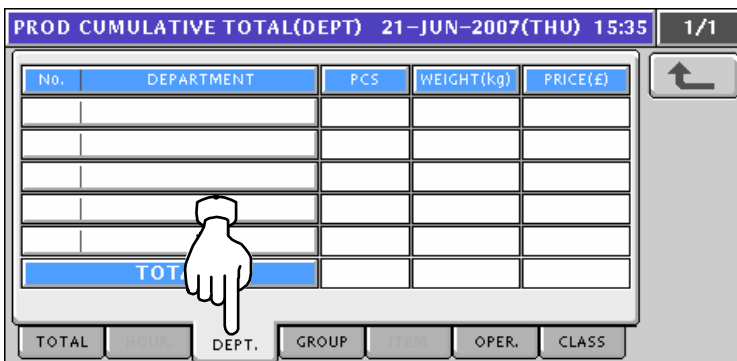

4. To obtain total for each group, press the [GROUP] tab on the screen. To change the pages, press the [▼] or [▲] button on the screen.

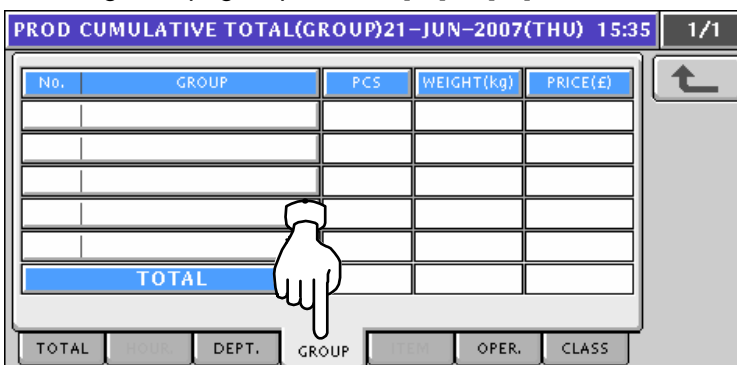

5. To obtain total for each operator, press the [OPER.] tab on the screen.
To change the pages, press the [▼] or [▲] button on the screen.

No.	OPERATOR	PCS	WEIGHT(kg)	PRICE(£)
TOTAL		0		0.00

TOTAL DEPT. GROUP OPER. CLASS

6. To obtain analysis totals, press the [CLASS] tab on the screen.
To change the pages, press the [▼] or [▲] button on the screen.

CLASS ANALYZE		
NO	DEPT.	GROUP

CLASS

- PLU No.
- ABC PRICE
- ABC WEIGHT
- ABC PCS
- Z PRICE
- Z WEIGHT
- Z PCS

TOTAL DEPT. GROUP OPER. CLASS ANALY SYS

NO	The object of analysis is not specified.
DEPT.	The object of analysis is specified to be departments.
GROUP	The object of analysis is specified to be groups.
PLU No.	Analysis is performed in ascending PLU number order.
ABC PRICE	Analysis is performed in descending price order.
ABC WEIGHT	Analysis is performed in descending weight order.
ABC PCS	Analysis is performed in descending quantity order.
Z PRICE	Analysis is performed in ascending price order.
Z WEIGHT	Analysis is performed in ascending weight order.
Z PCS	Analysis is performed in ascending quantity order.

9.4 TRACEABILITY TOTAL

1. Press the "TRACEABILITY TOTAL" filed.

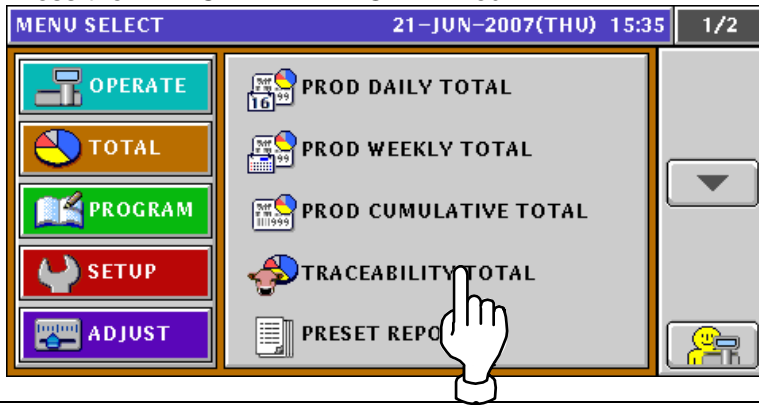

2. The Traceability Item screen appears.
 To change the pages, press the [▼] or [▲] button on the screen.
 To obtain Traceability Total screen, press the [DETAIL] button on the screen.

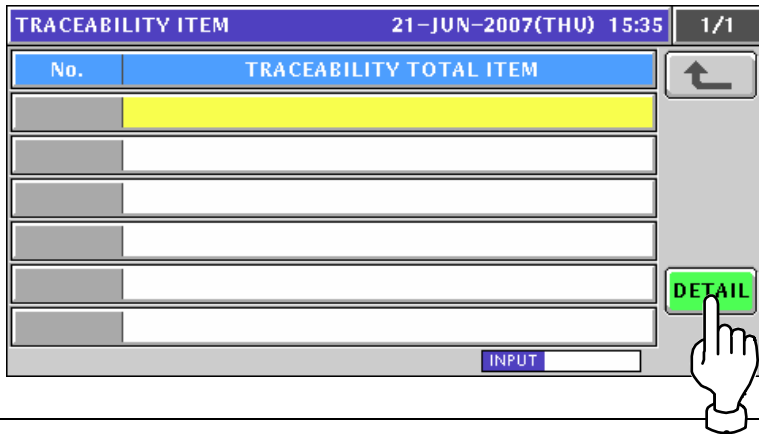

3. The Traceability Total screen appears.

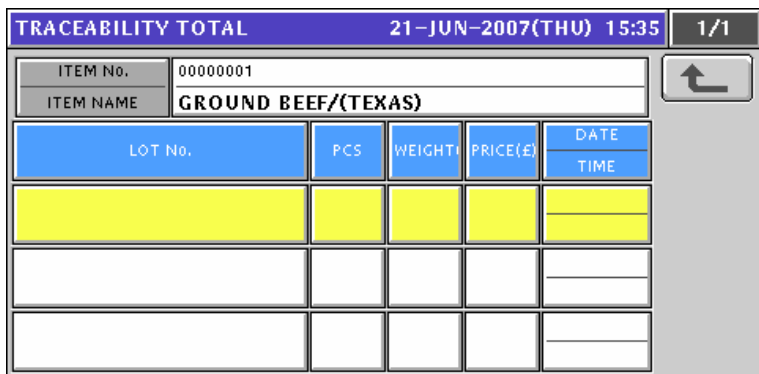

9.5 PRESET REPORT PRINTING

1. Press the "PRESET REPORT" filed.

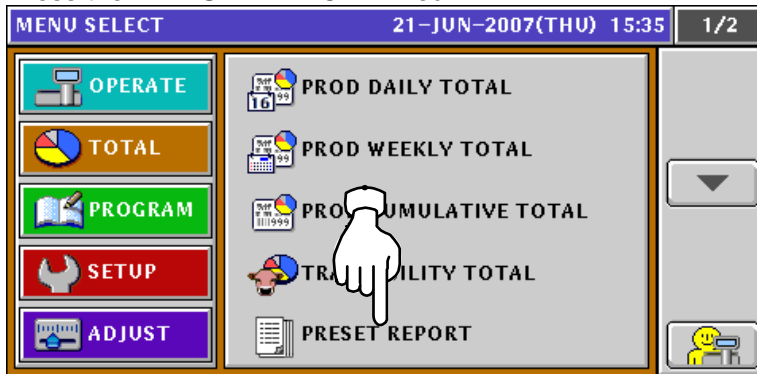

2. The Preset Report screen appears.

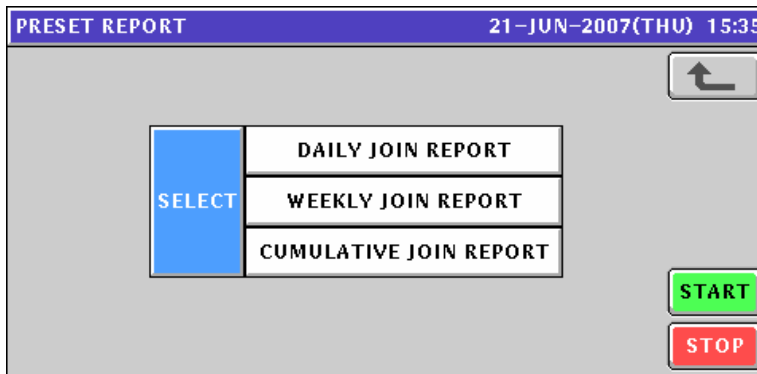

3. Select desired reports by pressing the corresponding fields. Press the [STRAT] button to issue selected join reports.

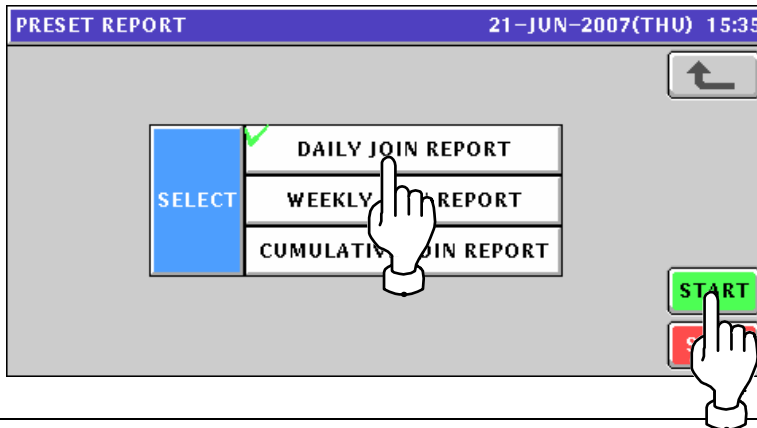

9.6 TOTAL CLEAR

1. Press the [▼] button on the screen.

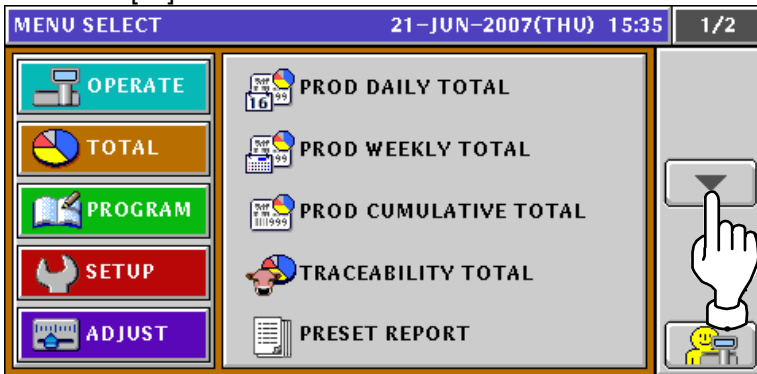

2. The second page of the Menu Select screen appears. To obtain the Total Clear screen, press the "TOTAL CLEAR" field on the screen.

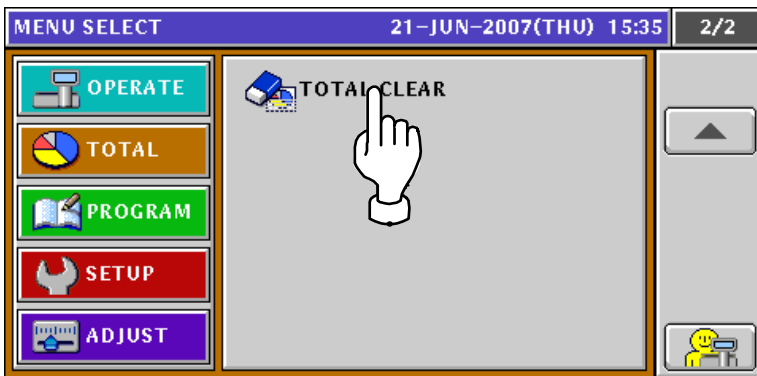

3. The Total Clear screen appears.

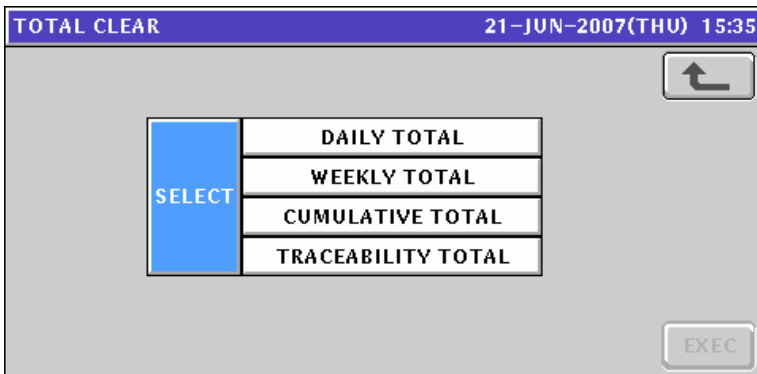

4. Select desired reports to be cleared by pressing the corresponding fields.

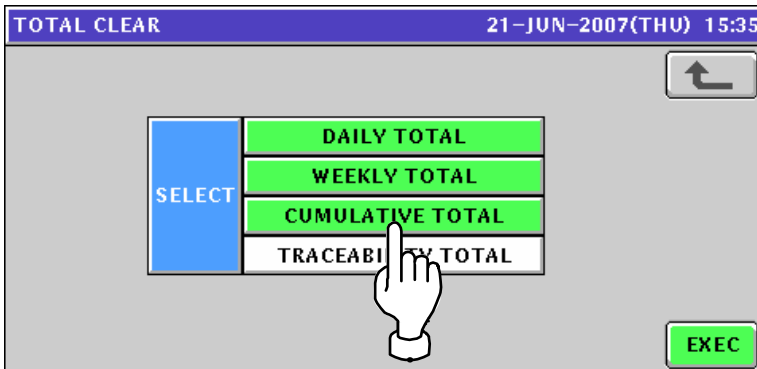

5. Press the [EXEC] button.

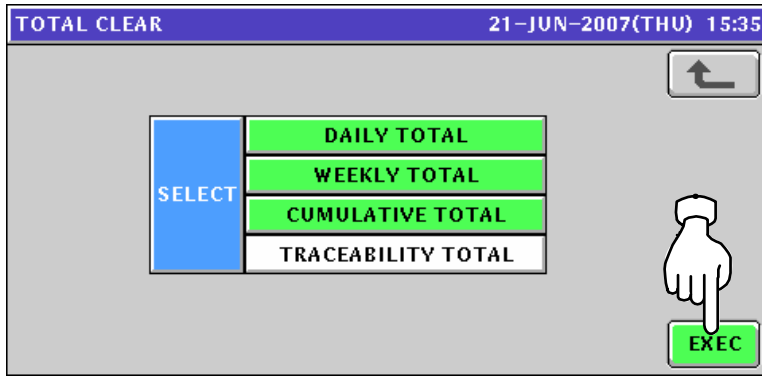

6. The confirmation screen appears. Then, press the [EXEC] button on the screen for execution.

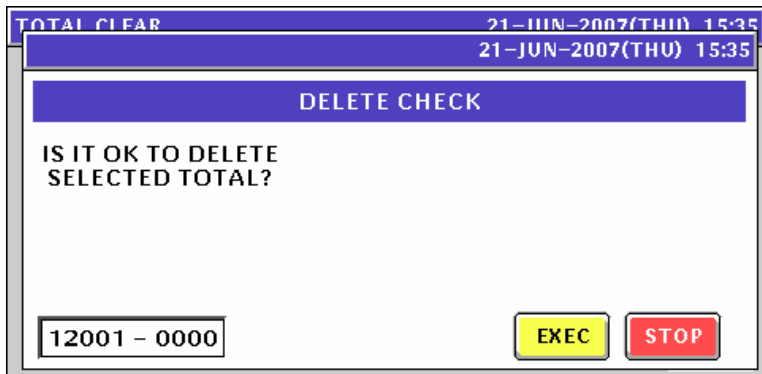

PROGRAM MODE

10.1 PROGRAM MODE ENTRY

1. Ensure that the initial screen is displayed.

PLU 0					21-JUN-2007(THU) 11:13		TARE	kg
Check the weight before operation. Enter PLU No. and press [PLU] key.								0.000
ZERO								WEIGHT kg
0.000								
UNIT PRICE £/kg								
0.00								
TOTAL PRICE £								
0.00								
GROUND BEEF (TEXAS)	GROUND BEEF (OREGON)	GROUND BEEF (UTAH)	SLICED BEEF	SLICED BEEF SPECIAL				
ROAST BEEF	ROAST BEEF SPECIAL	LAMB CHOP'S	LAMB CHOP'S SPECIAL	T-BONE STEAK				
OPERATOR GROUP	PRN MD. <AUTO>	CASSETTE 1	SUBTOTAL DISPLAY					

2. Press the [MODE] key on the key sheet.

Mode

The Operation Menu Select screen appears.
Then, press the [PROGRAM] button on the screen.

MENU SELECT		21-JUN-2007(THU) 11:13		1/1
OPERATE	SALES			
TOTAL	ACC1			
PROGRAM	ACC2			
SETUP	ACC3			
ADJUST	TOTAL ADJUST			

3. The Program Menu Select screen appears.
To change the pages, press the [▼] or [▲] button on the screen.

MENU SELECT		21-JUN-2007(THU) 11:13		1/8
OPERATE	PLU PLU FILE			
TOTAL	CAMPAIGN			
PROGRAM	OPERATORS			
SETUP	PRESET KEY			
ADJUST	AD MSG			



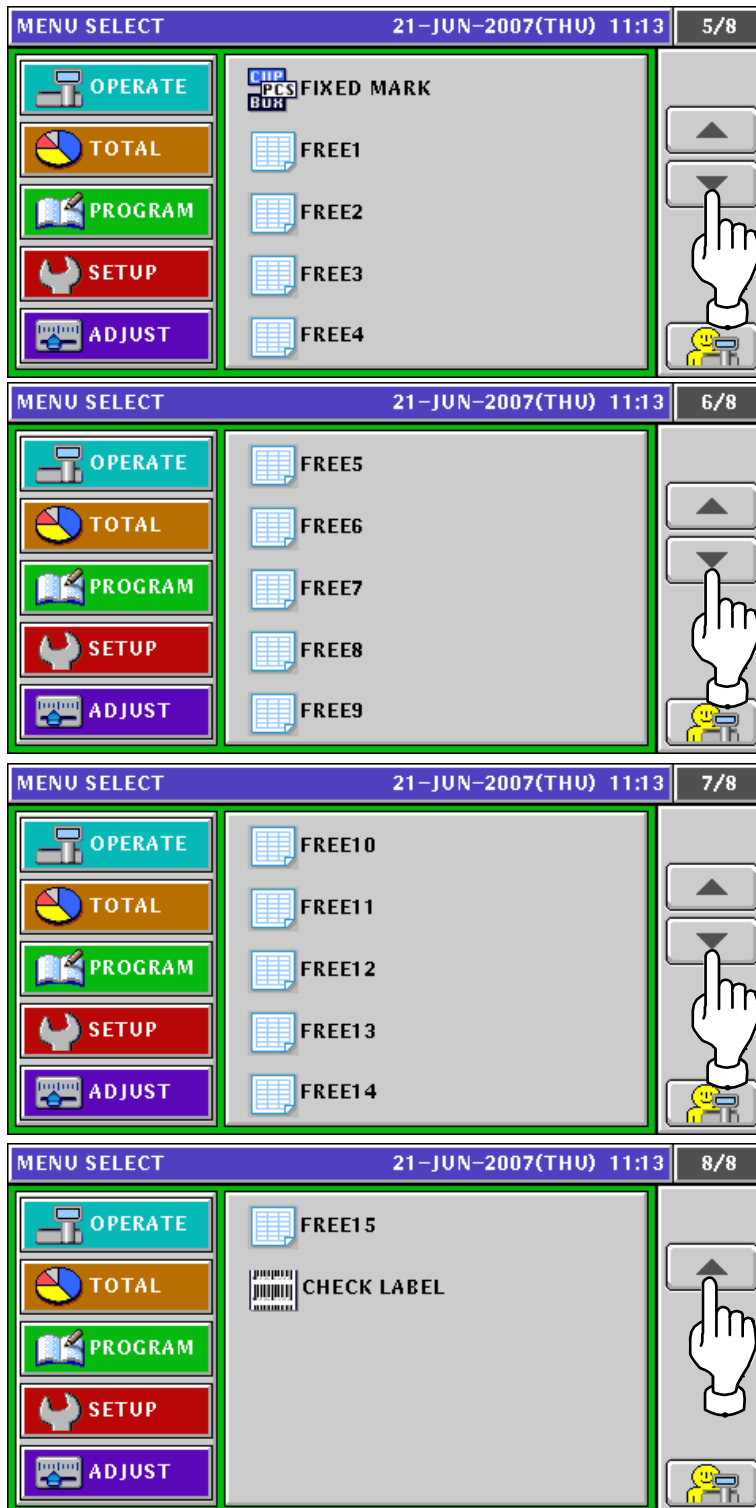

Note: To exit the Program Mode, press the [ESC] (Escape) key on the key sheet.

10.2 PLU FILE REGISTRATION

1. Press the "PLU FILE" field on the Program Menu Select screen.

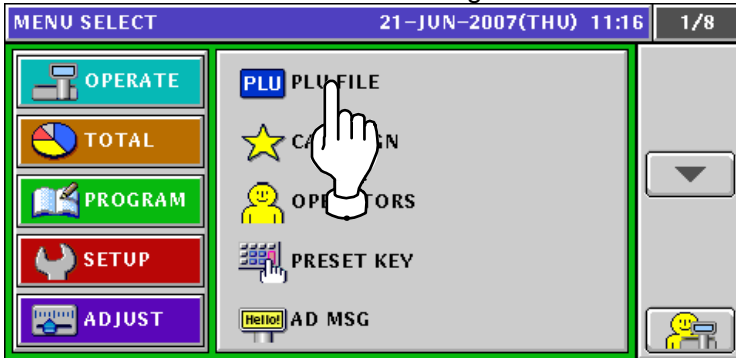

2. The Item List screen appears. To change the pages, press the [▼] or [▲] button on the screen



3. Press to select a desired field. Then, press the [DETAIL] button on the screen.

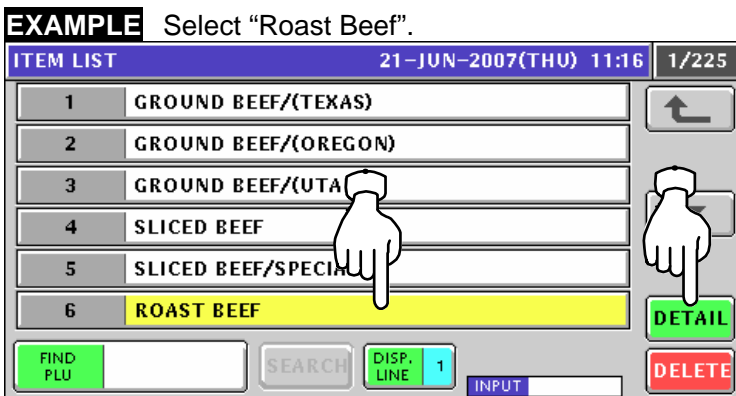

4. The Item Detail screen appears. To edit the PLU name, press the [EDIT] button on the screen.

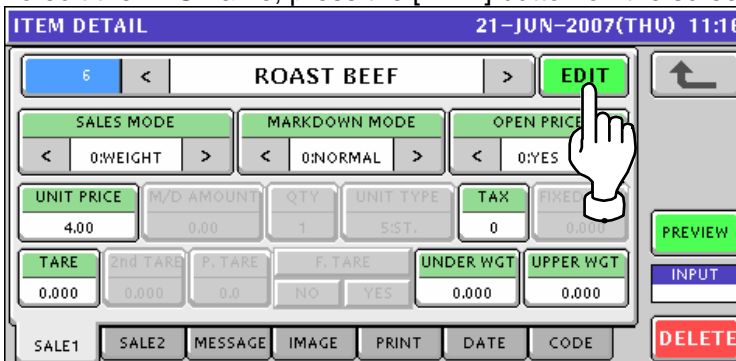

5. The text edit screen appears.
Edit a text according to the procedure explained in Appendix "Text Editing".

ITEM DETAIL(ITEM NAME EDIT)					21-JUN-2007(THU) 11:16	
ROAST BEEF						
Q	W	E	R	T	Y	U
A	S	D	F	G	H	J
	Z	X	C	V	B	N
No.	CHAR	REMAIN	STYLE	FONT	INPUT	ERASE
6	010	5109	/	30x15/30x15		

6. Ensure that the first sales related screen is displayed.

Sales Mode: Weighing Product

ITEM DETAIL					21-JUN-2007(THU) 11:16	
6	<	ROAST BEEF	>	EDIT		
SALES MODE		MARKDOWN MODE		OPEN PRICE		
<	0:WEIGHT	>	<	0:NORMAL	>	
UNIT PRICE	M/D AMOUNT	QTY	UNIT TYPE	TAX	FIXED WGT	
4.00	0.00	1	S:ST.	0	0.000	
TARE	END TARE	P. TARE	F. TARE	UNDER WGT	UPPER WGT	
0.000	0.000	0.0	NO YES	0.000	0.000	
SALE1	SALE2	MESSAGE	IMAGE	PRINT	DATE	CODE
						DELETE

Sales Mode: Fixed Price Product

ITEM DETAIL					21-JUN-2007(THU) 11:16	
6	<	ROAST BEEF	>	EDIT		
SALES MODE		MARKDOWN MODE		OPEN PRICE		
<	1:FIX PRI	>	<	0:NORMAL	>	
FIXED PRICE	M/D AMOUNT	QTY	UNIT TYPE	TAX	FIXED WGT	
4.00	0.00	0	0:NO PRN	0	0.000	
TARE	END TARE	P. TARE	F. TARE	UNDER WGT	UPPER WGT	
0.000	0.000	0.0	NO YES	0.000	0.000	
SALE1	SALE2	MESSAGE	IMAGE	PRINT	DATE	CODE
						DELETE

Sales Mode: Weighing Fixed Price Product

ITEM DETAIL					21-JUN-2007(THU) 11:16	
6	<	ROAST BEEF	>	EDIT		
SALES MODE		MARKDOWN MODE		OPEN PRICE		
<	2:WGT F/PRI	>	<	0:NORMAL	>	
FIXED PRICE	M/D AMOUNT	QTY	UNIT TYPE	TAX	FIXED WGT	
4.00	0.00	0	0:NO PRN	0	0.000	
TARE	END TARE	P. TARE	F. TARE	UNDER WGT	UPPER WGT	
0.000	0.000	0.0	NO YES	0.000	0.000	
SALE1	SALE2	MESSAGE	IMAGE	PRINT	DATE	CODE
						DELETE

Sales Mode: Fixed Unit Price Product

The screenshot shows the 'ITEM DETAIL' screen for 'ROAST BEEF' on 21-JUN-2007(THU) at 11:16. The screen is divided into several sections:

- Item Information:** Item number '6', name 'ROAST BEEF', and an 'EDIT' button.
- Mode Selection:** Three main sections: 'SALES MODE' (set to '3:FIX UP'), 'MARKDOWN MODE' (set to '0:NORMAL'), and 'OPEN PRICE' (set to '0:YES'). Each has left and right arrow buttons for navigation.
- Input Fields:** Fields for 'UNIT PRICE' (4.00), 'M/D AMOUNT' (0.00), 'QTY' (0), 'UNIT TYPE' (0:NO PRN), 'TAX' (0), and 'FIXED WGT' (0.000). Below these are 'TARE' (0.000), 'END TARE' (0.000), 'P. TARE' (0.0), 'F. TARE' (NO), 'UNDER WGT' (0.000), and 'UPPER WGT' (0.000).
- Buttons:** 'PREVIEW', 'INPUT', and 'DELETE' buttons are visible on the right side.
- Footer:** A row of buttons for 'SALE1', 'SALE2', 'MESSAGE', 'IMAGE', 'PRINT', 'DATE', 'CODE', and 'DELETE'.

ITEM	DESCRIPTION
SALES MODE	<p>Press the [<] or [>] button to select a desired sales mode.</p> <p>0: Weighing product 1: Fixed price product 2: Weighing fixed price product 3: Fixed unit price product</p>
MARKDOWN MODE	<p>Press the [<] or [>] button to select a desired markdown mode.</p> <p>0: Normal price 1: Special price 2: Amount discount for total price 3: Percent discount for total price 4: Special unit price 5: Amount discount for unit price 6: Percent discount for unit price</p>
OPEN PRICE	Press the [<] or [>] button to select whether or not to allow an open price system.
UNIT PRICE FIXED PRICE	Enter a unit price or fixed price, and press this field.
M/D AMOUNT	Enter a markdown amount or percentage and press this field.
QTY (Quantity)	Enter a packed quantity, and press this field.
UNIT TYPE	<p>Press this field to display the Fix Price Mark List screen.</p> <p>The 'FIX PRICE MARK LIST' screen shows a list of unit types with selection arrows on the right. A hand icon indicates the selection process. At the bottom, there are 'FIND PLU' and 'SEARCH' buttons, and an 'INPUT' button.</p> <p>Press to select a desired field.</p>
TAX	Enter a desired number and press this field.
FIXED WEIGHT	Enter a fixed weight, and press this field.
TARE	Enter a tare weight, and press this field.
UNDER WEIGHT	Enter a lower weight limit, and press this field.
UPPER WEIGHT	Enter a upper weight limit, and press this field.

7. Press the [SALE2] tab to select the second sales related screen.

ITEM DETAIL 21-JUN-2007(THU) 11:16

6 < ROAST BEEF > EDIT

POINT FLAG: 0:OFF POINT TYPE: 0:WGT POINTS: 0

SALE1 SALE2 MESSAGE IMAGE PRINT DATE CODE PREVIEW INPUT DELETE

ITEM	DESCRIPTION
POINT FLAG	Press the [<] or [>] button to select whether or not to use the Point Flag. 0: OFF 1: ON
POINT TYPE	Press the [<] or [>] button to select a desired Point Type. 0: Weight 1: Fixed weight
POINTS	Enter a desired number and press this field

- 8-1 Press the [MESSAGE] tab to select the message related screen.

ITEM DETAIL(MESSAGE) 21-JUN-2007(THU) 11:16 1/6

6 < ROAST BEEF >

NUTRITION(USA) 0 NONE
EXTRA MESSAGE1 0 NONE
EXTRA MESSAGE2 0 NONE
EXTRA MESSAGE3 0 NONE

SALE1 SALE2 MESSAGE IMAGE PRINT DATE CODE PREVIEW INPUT

- 8-2 Press to select a desired field.

EXAMPLE "Extra Message 1".

ITEM DETAIL(MESSAGE) 21-JUN-2007(THU) 11:16 1/6

6 < ROAST BEEF >

NUTRITION(USA) 0 NONE
EXTRA MESSAGE1 0 NONE
EXTRA MESSAGE2 0 NONE
EXTRA MESSAGE3 0 NONE

SALE1 SALE2 MESSAGE IMAGE PRINT DATE CODE PREVIEW INPUT

8-3 The Extra Message List screen appears. Then, press to select a desired field.

EXAMPLE "Extra Message BB".

The screenshot shows the 'EXTRA MSG1 LIST' screen for '21-JUN-2007(THU) 11:16'. The list contains the following items:

0	NONE
1	EXTRA MESSAGE AA
2	EXTRA MESSAGE BB
3	EXTRA MESSAGE

Below the list are buttons for 'FIND PLU', 'SEARCH', 'DISP. LINE' (set to 1), and 'INPUT'.

The second screenshot shows the 'ITEM DETAIL(MESSAGE)' screen for '21-JUN-2007(THU) 11:17'. The item is 'ROAST BEEF'. The message details are:

NUTRITION(USA)	0	NONE
EXTRA MESSAGE1	2	EXTRA MESSAGE BB
EXTRA MESSAGE2	0	NONE
EXTRA MESSAGE3	0	NONE

At the bottom, there are tabs for 'SALE1', 'SALE2', 'MESSAGE', 'IMAGE', 'PRINT', 'DATE', and 'CODE'. A 'PREVIEW' button is also visible.

9-1 Press the [IMAGE] tab to select the image related screen.

The screenshot shows the 'ITEM DETAIL(IMAGE)' screen for '21-JUN-2007(THU) 11:16'. The item is 'ROAST BEEF'. The image selection options are:

IMAGE1	0	IMAGE2	0
IMAGE3	0	DISP IMG	3
SH IMAGE	2	SAFE HANDLING IMAGE	

The 'SAFE HANDLING IMAGE' section has a checked box and 'NO PRINT' and 'PRINT' buttons. A 'PREVIEW' button is also visible.

9-2 Press to select a desired field.

EXAMPLE Select a desired image for "Image 1".

The screenshot shows the 'ITEM DETAIL(IMAGE)' screen for '21-JUN-2007(THU) 11:16'. The item is 'ROAST BEEF'. The image selection options are:

IMAGE1	0	IMAGE2	0
IMAGE3	0	DISP IMG	3
SH IMAGE	2	SAFE HANDLING IMAGE	

The 'SAFE HANDLING IMAGE' section has a checked box and 'NO PRINT' and 'PRINT' buttons. A 'PREVIEW' button is also visible.

- 9-3** The Image List screen appears. Then, press to select a desired field and press the [SET] button.

EXAMPLE Select "Image No.8".

IMAGE LIST		21-JUN-2007(THU) 11:16		1/4
No.	IMAGE	No.	IMAGE	
0	NO IMAGE	5		<input type="button" value="↑"/> <input type="button" value="↓"/> <input type="button" value="MAIL"/> <input type="button" value="SET"/>
1		6		
2		8	MEMBER SAVINGS	
3		9	THANK YOU FOR YOUR BUSINESS	
4		10	YOU SAVED	

- 10.** Select whether or not to print Safe handling Image by pressing a desired field.

ITEM DETAIL(IMAGE)		21-JUN-2007(THU) 11:16	
6	< ROAST BEEF >		
IMAGE1		IMAGE2	0
IMAGE3	0	DISP IM	3
SH IMAGE		SAFE HANDLING IMAGE	<input checked="" type="checkbox"/> NO PRINT <input type="checkbox"/> PRINT
SALE1 SALE2 MESSAGE IMAGE PRINT DATE CODE		<input type="button" value="PREVIEW"/> <input type="button" value="INPUT"/>	

- 11-1** Press the [PRINT] tab to select the print related screen.

ITEM DETAIL(PRINT)		21-JUN-2007(THU) 11:16	
6	< ROAST BEEF >		
FIRST LABEL FORMAT NO.	3	SECOND LABEL FORMAT NO.	0
FIRST LABEL PRINT	< 1:YES >	SECOND LABEL PRINT	< >
SALE1 SALE2 MESSAGE IMAGE PRINT DATE CODE		<input type="button" value="PREVIEW"/> <input type="button" value="INPUT"/>	

- 11-2** Press the [First Label Format No.] button.

ITEM DETAIL(PRINT)		21-JUN-2007(THU) 11:16	
6	< ROAST BEEF >		
FIRST LABEL FORMAT NO.	3	SECOND LABEL FORMAT NO.	0
FIRST LABEL PRINT	< 2:NO >	SECOND LABEL PRINT	< >
SALE1 SALE2 MESSAGE IMAGE PRINT DATE CODE		<input type="button" value="PREVIEW"/> <input type="button" value="INPUT"/>	

11-3 The Format List screen appears.
Then, select a desired format by pressing the corresponding field.

EXAMPLE Select "Format No.5".

FORMAT LIST 21-JUN-2007(THU) 11:16 1/9

0	NONE
1	/ W:56.00 X H:76.00
2	/ W:56.00 X H:85.00
3	/ W:56.00 X H:59.00
4	/ W:56.00 X H:73.00
5	/ W:56.00 X H:59.00

INPUT

ITEM DETAIL(PRINT) 21-JUN-2007(THU) 11:16

6 < ROAST BEEF >

FIRST LABEL FORMAT No.	SECOND LABEL FORMAT No.
5	0
FIRST LABEL PRINT	SECOND LABEL PRINT
< 1:YES >	< 2:NO >

PREVIEW
INPUT

SALE1 SALE2 MESSAGE IMAGE PRINT DATE CODE

ITEM	DESCRIPTION
FIRST LABEL PRINT	Press the [<] or [>] button to select whether or not to print the first labels. 1: YES 2: NO
SECOND LABEL PRINT	Press the [<] or [>] button to select whether or not to print the second labels. 1: YES 2: NO

Note: The same procedure applies to the Second Label Format Number setting.

12. Pressing the [DATE] tab to select the date related screen.

ITEM DETAIL(DATE) 21-JUN-2007(THU) 11:16

6 < ROAST BEEF >

PACK DATE PRINT: YES (checked) NO

PACK TIME PRINT: < 1:DESIGNATE >

PACK TIME DATA: 00:00

SB DATE PRINT: YES (checked) NO

SB TIME PRINT: < 0:NO PRINT >

SB TIME DATA: 48 HOUR(S) AFTER

SHELF LIFE(days): 2 days

UB DATE PRINT: YES (checked) NO

UB DATE DATA: 5 days

SALE1 SALE2 MESSAGE IMAGE PRINT DATE CODE

PREVIEW INPUT

ITEM	DESCRIPTION
PACK DATE PRINT	Select whether or not to print the Pack Date.
PACK TIME PRINT	Press the [<] or [>] button to select a desired printing method. 0: No print 1: Designated time 2: System clock time
PACK TIME DATA	This field is available only when "Designated time" is selected in "PACK TIME PRINT". Enter the time and press this field.
SB DATE PRINT	Select whether or not to print the Sell-By Date.
SB TIME PRINT	Press the [<] or [>] button to select a desired printing method. 0: No print 1: Designated time 2: Relative time
SB TIME DATA	This field is available only when "Yes" is selected in "SB TIME PRINT". Enter the number of hours and press this field.
SHELF LIFE (days)	This field is available only when "Yes" is selected in "SB DATE PRINT". Enter the number of days and press this field.
UB DATE PRINT	Select whether or not to print the Use-By Date.
UB DATE DATA	This field is available only when "Yes" is selected in "UB DATE PRINT". Enter the number of hours and press this field

13. Select the code related screen by pressing the [CODE] tab.

ITEM DETAIL(CODE) 21-JUN-2007(THU) 11:17

6 < ROAST BEEF >

ITEM CODE: 00311006 REGI CODE: 0 POS FLAG: 02 BARCODE: 00000000000000

POS REFERENCE: < 0:REFER > BARCODE TYPE: 0:REFER POS FORMAT: REFER







TRACE ENABLE: YES NO

DEPARTMENT No.: 3 GROUP: []

SALE1 SALE2 MESSAGE IMAGE PRINT DATE CODE

PREVIEW INPUT

ITEM	DESCRIPTION
ITEM CODE	Enter an item code and press this field.
REGISTER CODE	Enter the register code and press this field.
POS FLAG	This field is available only when "PLU File" is selected in "POS REFERENCE". Enter the POS flag number and press this field.
BARCODE	Enter the barcode number and press this field.
POS REFERENCE	Select one of the following reference methods 0: Refer 1: PLU file
BARCODE TYPE	This field is available only when "PLU File" is selected in "POS REFERENCE". Press this field to get the Barcode Type screen and press to select one of the PLU types.
POS FORMAT	Press this field to get the Barcode Format screen and press to select one of the barcode formats.

	<div style="border: 1px solid black; padding: 5px; margin-bottom: 10px;"> <p style="text-align: right; margin: 0;">BARCODE FORMAT 21-JUN-2007(THU) 11:18 2/3</p> <table border="1" style="width: 100%; border-collapse: collapse;"> <tr> <td style="width: 50%;">0E Not Available</td> <td style="width: 50%;">15 FFCPPPPPP(C/D)</td> <td rowspan="8" style="text-align: center; vertical-align: middle;">  </td> </tr> <tr> <td>0F FFC(0)PPP(C/D)</td> <td>16 FCCWWWWPPP(C/D)</td> </tr> <tr> <td>10 FFCWWWW(C/D)</td> <td>17 FFCQQPPP(C/D)</td> </tr> <tr> <td>11 FFCPPPP(/10)(C/D)</td> <td>18 FIIIIPPP(C/D)</td> </tr> <tr> <td>12 FFC(C/P)PPP(/10)(C/D)</td> <td>19 FIIIIPPP(C/D)</td> </tr> <tr> <td>13 FFC(C/W)WWW(C/D)</td> <td>1A FCPPPPP(C/D)</td> </tr> <tr> <td>14 FCPPPPP(C/D)</td> <td>1B FIIIIPPP(/10)(C/D)</td> </tr> <tr> <td></td> <td></td> </tr> </table> </div> <div style="border: 1px solid black; padding: 5px;"> <p style="text-align: right; margin: 0;">BARCODE FORMAT 21-JUN-2007(THU) 11:18 3/3</p> <table border="1" style="width: 100%; border-collapse: collapse;"> <tr> <td style="width: 50%;">1C FIIIIPPP(/10)(C/D)</td> <td style="width: 50%;"></td> <td rowspan="8" style="text-align: center; vertical-align: middle;">  </td> </tr> <tr> <td>1D FFCPPPP(/10)(C/D)</td> <td></td> </tr> <tr> <td>1E FFCPPPP(/10)(C/D)</td> <td></td> </tr> <tr> <td>1F FFCQQQQ(C/D)</td> <td></td> </tr> <tr> <td></td> <td></td> </tr> <tr> <td></td> <td></td> </tr> <tr> <td></td> <td></td> </tr> <tr> <td></td> <td></td> </tr> </table> </div>	0E Not Available	15 FFCPPPPPP(C/D)		0F FFC(0)PPP(C/D)	16 FCCWWWWPPP(C/D)	10 FFCWWWW(C/D)	17 FFCQQPPP(C/D)	11 FFCPPPP(/10)(C/D)	18 FIIIIPPP(C/D)	12 FFC(C/P)PPP(/10)(C/D)	19 FIIIIPPP(C/D)	13 FFC(C/W)WWW(C/D)	1A FCPPPPP(C/D)	14 FCPPPPP(C/D)	1B FIIIIPPP(/10)(C/D)			1C FIIIIPPP(/10)(C/D)			1D FFCPPPP(/10)(C/D)		1E FFCPPPP(/10)(C/D)		1F FFCQQQQ(C/D)									
0E Not Available	15 FFCPPPPPP(C/D)																																		
0F FFC(0)PPP(C/D)	16 FCCWWWWPPP(C/D)																																		
10 FFCWWWW(C/D)	17 FFCQQPPP(C/D)																																		
11 FFCPPPP(/10)(C/D)	18 FIIIIPPP(C/D)																																		
12 FFC(C/P)PPP(/10)(C/D)	19 FIIIIPPP(C/D)																																		
13 FFC(C/W)WWW(C/D)	1A FCPPPPP(C/D)																																		
14 FCPPPPP(C/D)	1B FIIIIPPP(/10)(C/D)																																		
1C FIIIIPPP(/10)(C/D)																																			
1D FFCPPPP(/10)(C/D)																																			
1E FFCPPPP(/10)(C/D)																																			
1F FFCQQQQ(C/D)																																			
TRACE ENABLE	Select whether or not to enable a traceability function.																																		
DEPARTMENT No.	Press this field to get the Department List screen. Set the desired department simply by pressing the field on the list, or pressing the "Department No." field after a numeric entry.																																		
GROUP No.	Pressing this field displays the Group List. Set the desired group simply by pressing the field on the list, or pressing the "Group No." field after a numeric entry.																																		

10.3 CAMPAIGN LIST REGISTRATION

1. Press the "CAMPAIGN" field on the Program Menu Select screen.

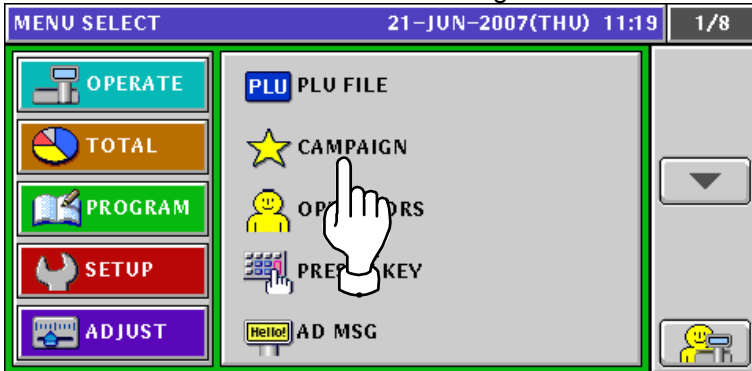

2. The Campaign List appears. To change the pages, press the [▼] or [▲] button on the screen.

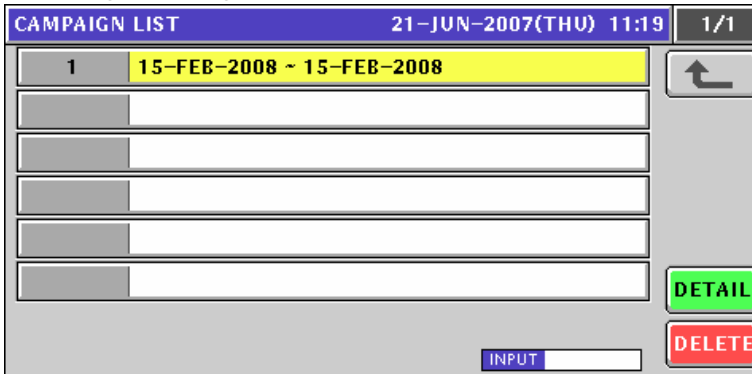

3. Create a new campaign file by entering a campaign number and pressing the [PLU] key on the key sheet.

EXAMPLE Campaign number "2".

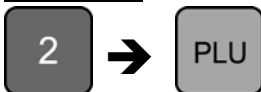

The confirmation screen appears. Then, press the [ENTER] button.

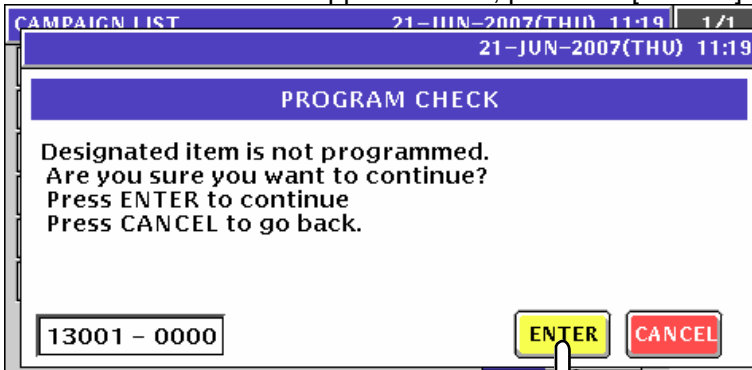

4. The designated Campaign Data List screen appears.

CAMPAIGN DATA LIST		21-JUN-2007(THU) 11:20		1/1
CAMPAIGN No	2	INPUT THE TIMES(24 HOUR) AND DATES(8 DIGIT)		
START DATE(DD/MM/YYYY)	21-JUN-2007	START TIME(HH:MM)	00:00	
END DATE(DD/MM/YYYY)	21-JUN-2007	END TIME(HH:MM)	23:59	
ITEM No	ITEM NAME	MD MODE	MD PRI	
INPUT				DELETE

5. Enter the campaign start date and press the "Start Date" display field. .

EXAMPLE Start date "June 25, 2007"

2	5	0	6	2	0	0	7
---	---	---	---	---	---	---	---

CAMPAIGN DATA LIST		21-JUN-2007(THU) 11:20		1/1
CAMPAIGN No	2	INPUT THE TIMES(24 HOUR) AND DATES(8 DIGIT)		
START DATE(DD/MM/YYYY)	25-JUN-2007	START TIME(HH:MM)	08:00	
END DATE(DD/MM/YYYY)	21-JUN-2007	END TIME(HH:MM)	23:59	
ITEM No	ITEM NAME	MD MODE	MD PRI	
INPUT 29062007				DELETE

6. Enter the start time and press the "Start Time" display field. .

EXAMPLE Start time "08:00"

0	8	0	0
---	---	---	---

CAMPAIGN DATA LIST		21-JUN-2007(THU) 11:21		1/1
CAMPAIGN No	2	INPUT THE TIMES(24 HOUR) AND DATES(8 DIGIT)		
START DATE(DD/MM/YYYY)	25-JUN-2007	START TIME(HH:MM)	08:00	
END DATE(DD/MM/YYYY)	27-JUN-2007	END TIME(HH:MM)	23:59	
ITEM No	ITEM NAME	MD MODE	MD PRI	
INPUT				DELETE

7. Enter the campaign end date and press the “End Date” display field. .

EXAMPLE End date "June 27, 2007"



CAMPAIGN DATA LIST		21-JUN-2007(THU) 11:21		1/1
CAMPAIGN No	2	INPUT THE TIMES(24 HOUR) AND DATES(8 DIGIT)		↶
START DATE(DD/MM/YYYY)	25-JUN-2007	START TIME(HH:MM)	08:00	CALL
END DATE(DD/MM/YYYY)	27-JUN-2007	END TIME(HH:MM)	21:00	
ITEM No	ITEM NAME	MD MODE	MD PRI	DELETE
INPUT				

8. Enter the end time and press the “End Time” display field.

EXAMPLE End time "21:00"

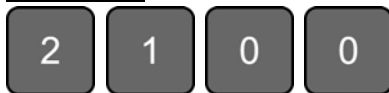

CAMPAIGN DATA LIST		21-JUN-2007(THU) 11:21		1/1
CAMPAIGN No	2	INPUT THE TIMES(24 HOUR) AND DATES(8 DIGIT)		↶
START DATE(DD/MM/YYYY)	25-JUN-2007	START TIME(HH:MM)	08:00	CALL
END DATE(DD/MM/YYYY)	27-JUN-2007	END TIME(HH:MM)	21:00	
ITEM No	ITEM NAME	MD MODE	MD PRI	DELETE
INPUT				

9. Press the [CALL] button to call up Item List screens

CAMPAIGN DATA LIST		21-JUN-2007(THU) 11:21		1/1
CAMPAIGN No	2	INPUT THE TIMES(24 HOUR) AND DATES(8 DIGIT)		↶
START DATE(DD/MM/YYYY)	25-JUN-2007	START TIME(HH:MM)	08:00	CALL
END DATE(DD/MM/YYYY)	27-JUN-2007	END TIME(HH:MM)	21:00	
ITEM No	ITEM NAME	MD MODE	MD PRI	DELETE
INPUT				

10. The Item List screen appears. Then, press to select a desired item field.

EXAMPLE PLU number "4"

ITEM LIST		21-JUN-2007(THU) 11:21	1/225
1	GROUND BEEF/(TEXAS)		
2	GROUND BEEF/(OREGON)		
3	GROUND BEEF/(UTAH)		
4	SLICED BEEF		
5	SLICED BEEF/SPECIAL		
6	ROAST BEEF		

FIND PLU SEARCH DISP. LINE 1 INPUT

11. The Campaign Data List screen appears. Then, press the [CALL] button again when selecting the next item.

CAMPAIGN DATA LIST		21-JUN-2007(THU) 11:21	1/1
CAMPAIGN No	2	INPUT THE TIMES(24 HOUR) AND DATES(8 DIGIT)	
START DATE(DD/MM/YYYY)	25-JUN-2007	START TIME(HH:MM)	08:00
END DATE(DD/MM/YYYY)	27-JUN-2007	END TIME(HH:MM)	21:00
ITEM No	ITEM NAME	MD MODE	MD PRI
4	SLICED BEEF	SPECIAL	0.00

CALL DELETE INPUT

The pop-up list appears. Then, press to select a desired field.

EXAMPLE Percent discount "-%"

CAMPAIGN DATA LIST		21-JUN-2007(THU) 11:21	1/1
CAMPAIGN No	2	INPUT THE TIMES(24 HOUR) AND DATES(8 DIGIT)	
START DATE(DD/MM/YYYY)	25-JUN-2007	START TIME(HH:MM)	08:00
END DATE(DD/MM/YYYY)	27-JUN-2007	END TIME(HH:MM)	21:00
ITEM No	ITEM NAME	MD MODE	MD PRI
4	SLICED BEEF	SPECIAL	0.00

CALL DELETE INPUT

CAMPAIGN DATA LIST		21-JUN-2007(THU) 11:22	1/1
CAMPAIGN No	2	INPUT THE TIMES(24 HOUR) AND DATES(8 DIGIT)	
START DATE(DD/MM/YYYY)	25-JUN-2007	START TIME(HH:MM)	08:00
END DATE(DD/MM/YYYY)	27-JUN-2007	END TIME(HH:MM)	21:00
ITEM No	ITEM NAME	MD MODE	MD PRI
4	SLICED BEEF	-%	0.0

CALL DELETE INPUT

12. Enter a numeric value and press the “Markdown Price” field for registration.

EXAMPLE 10%



CAMPAIGN DATA LIST				21-JUN-2007(THU) 11:22		1/1
CAMPAIGN No		2		INPUT THE TIMES(24 HOUR) AND DATES(8 DIGIT)		
START DATE(DD/MM/YYYY)		25-JUN-2007		START TIME(HH:MM)		08:00
END DATE(DD/MM/YYYY)		27-JUN-2007		END TIME(HH:MM)		21:00
ITEM No	ITEM NAME	MD MODE	MD PRI			
4	SLICED BEEF	-%	10.0	CALL		
				DELETE		
INPUT						

13. Repeat steps 9 through 12 for further registration. Then, press the Return button to finalize this procedure.

CAMPAIGN DATA LIST				21-JUN-2007(THU) 11:23		1/1
CAMPAIGN No		2		INPUT THE TIMES(24 HOUR) AND DATES(8 DIGIT)		
START DATE(DD/MM/YYYY)		25-JUN-2007		START TIME(HH:MM)		08:00
END DATE(DD/MM/YYYY)		27-JUN-2007		END TIME(HH:MM)		21:00
ITEM No	ITEM NAME	MD MODE	MD PRI			
4	SLICED BEEF	-%	10.0	CALL		
6	ROAST BEEF	SPECIAL	1.00	DELETE		
INPUT						

The Campaign List screen appears.

CAMPAIGN LIST		21-JUN-2007(THU) 11:23		1/1
1	15-FEB-2008 ~ 15-FEB-2008			
2	25-JUN-2007 ~ 27-JUN-2007	DETAIL		
		DELETE		
INPUT				

10.4 OPERATOR REGISTRATION

1. Press the "OPERATORS" field on the Program Menu Select screen.

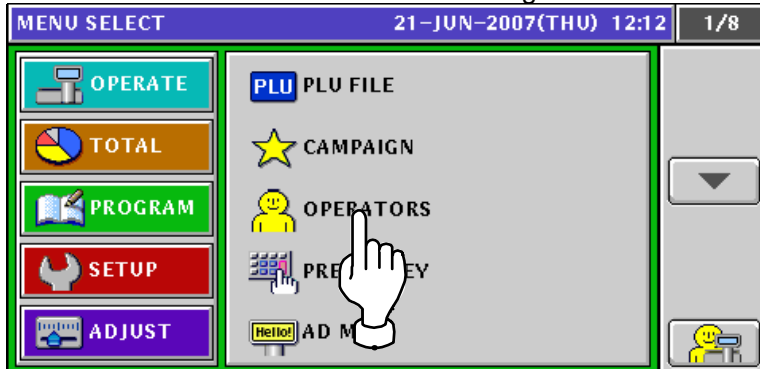

2. The Operator List screen appears.

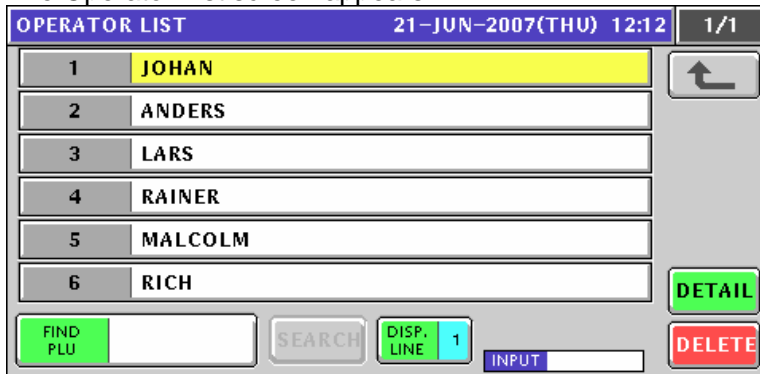

3. To create a new operator, enter the operator number and press the [PLU] key on the key sheet.

EXAMPLE Operator number "7".



The confirmation screen appears. Press the [ENTER] button.

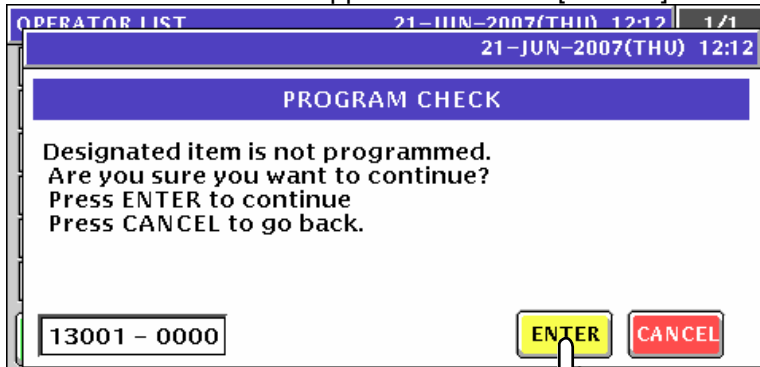

4. The Operator Edit screen appears for the selected operator number.



Edit a text according to the procedures described in Appendix "Text Editing".

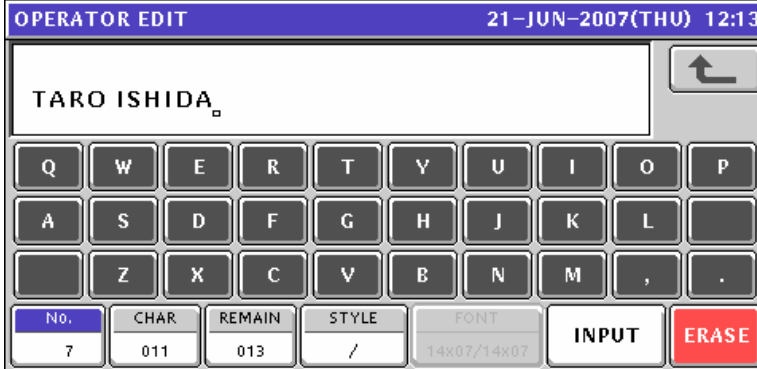

5. Press the [ESC] key on the key sheet to escape from text editing mode.



The confirmation screen appears.
Then, press the [SAVE] button to save the data.

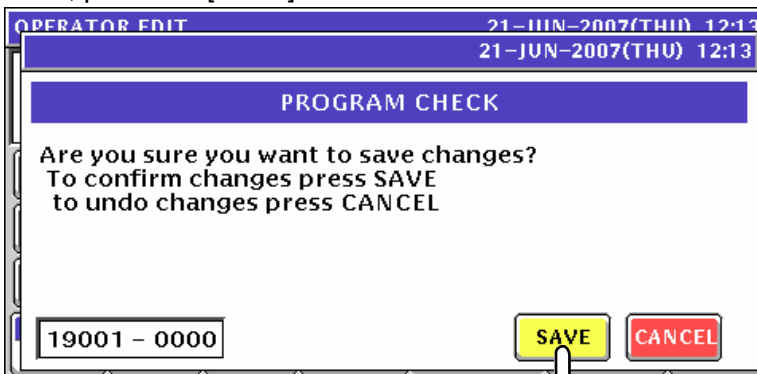

6. The edited text has been registered.

The screenshot shows the 'OPERATOR LIST' screen. At the top, it displays '21-JUN-2007(THU) 12:13' and '2/2'. The first entry is '7 TARO ISHIDA', which is highlighted in yellow. Below this are four empty rows. On the right side, there are two buttons: a return key (↵) and an up arrow key (↑). At the bottom, there are several controls: a 'FIND PLU' button, a 'SEARCH' button, a 'DISP. LINE' button with '1' next to it, an 'INPUT' field, a 'DETAIL' button, and a 'DELETE' button.

7. Press the Return button to finalize this procedure.

This screenshot is identical to the one above, but with a hand cursor pointing to the return key (↵) on the right side of the screen, indicating the next step in the procedure.

10.5 PRESET KEY REGISTRATION

10.5.1 SETTING PRESET FUNCTIONS

1. Press the "PRESET KEY" field on the screen.

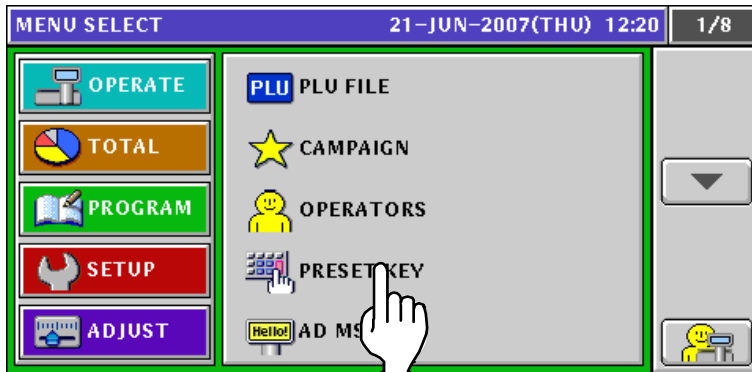

2. The Preset Key (Panel) screen appears.

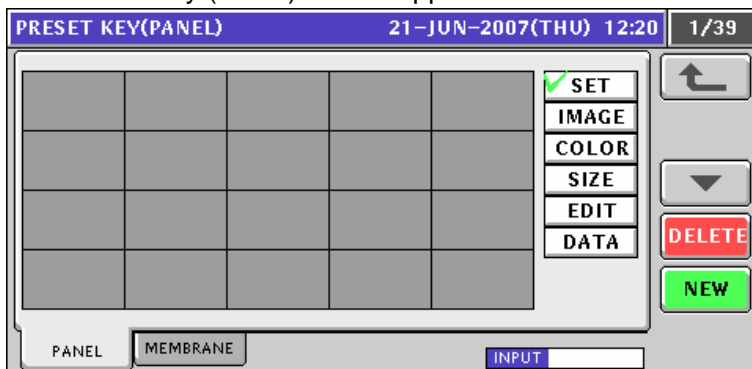

3. Ensure that the [SET] button is selected.

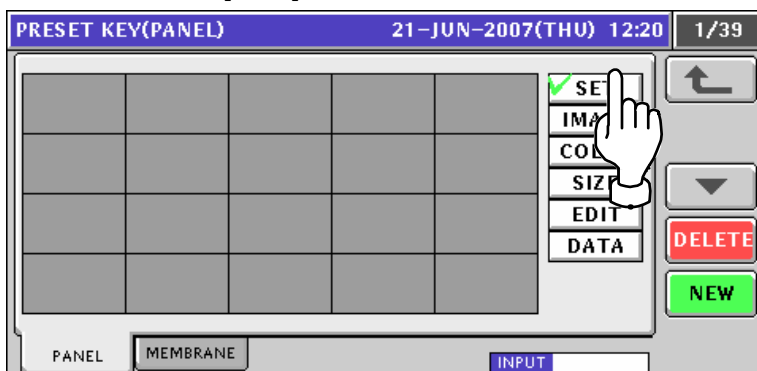

4. Press a desired button to which a preset function will be assigned.

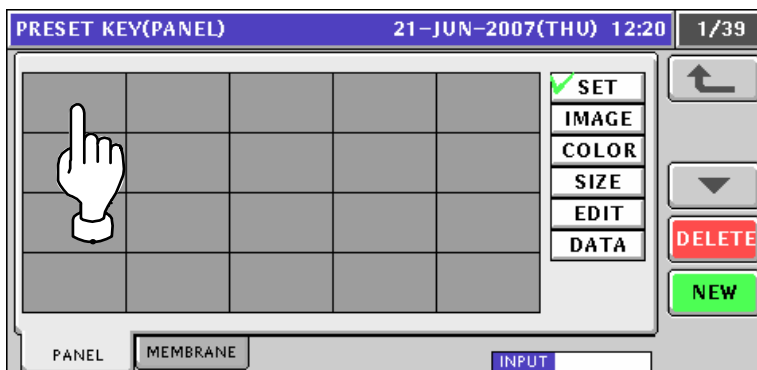

5. Available functions are listed on the screens. To change the pages, press the [▼] or [▲] button on the screen.

FUNCTION LIST		21-JUN-2007(THU) 12:20	1/5
0	NO	31	FEED
64	CATEGORY SELECT	30	PRINT
62	GROUP SELECT	68	2nd LABEL ONLY PRINT
94	FUNCTION GROUP	46	PRN QTY
95	OPERATOR GROUP	70	CASSETTE
1	PLU	75	AUTO PRINT MODE
76	PLU No.	26	PEEL MD.
		INPUT	SET

FUNCTION LIST		21-JUN-2007(THU) 12:20	2/5
27	LABEL BATCH	43	TOTAL DISPLAY
65	TARGET	15	SUBTOTAL DISPLAY
2	TARE	44	CALCULATOR
8	SAVE	73	ERROR LOG
78	TOTAL ADD	4	MULTI
74	KEY LOCK	77	1/2
10	VOID	32	U/P
		INPUT	SET

FUNCTION LIST		21-JUN-2007(THU) 12:20	3/5
3	F/P	25	-E(U/P)
72	FIX UPR	66	-%(U/P)
19	FIX UPR +WEIGHT	33	P DATE
5	SPECIAL	34	S DATE
6	-E	9	POP
7	-%	11	COUPON MSG
20	SP.(U/P)	16	EXTRA1
		INPUT	SET

FUNCTION LIST		21-JUN-2007(THU) 12:20	4/5
17	EXTRA2	52	FREE6
18	EXTRA3	53	FREE7
47	FREE1	54	FREE8
48	FREE2	55	FREE9
49	FREE3	56	FREE10
50	FREE4	57	FREE11
51	FREE5	58	FREE12
		INPUT	SET

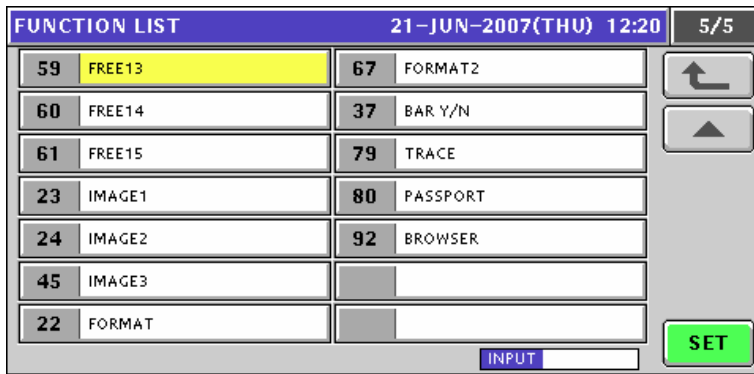

6. Press to select the desired function on the list, and press the [SET] button.

EXAMPLE Select PLU function.

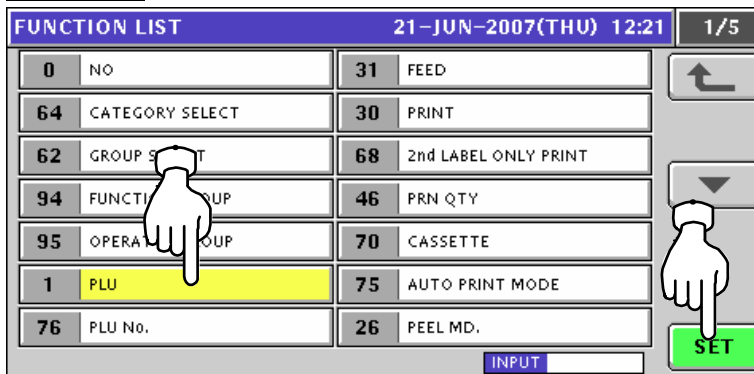

7. The Item List screen appears. Then, press to select a desired field.

EXAMPLE Select PLU No.2.



8. The selected PLU has been assigned.

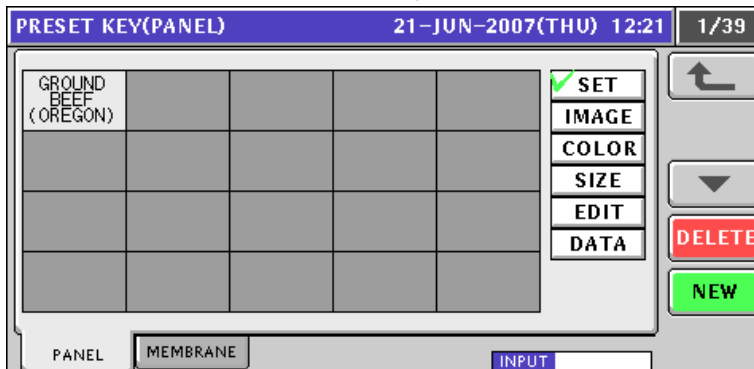

9. Repeat steps 4 through 8 for more registrations.

10.5.2 ASSIGNING IMAGES ON THE PRESET KEYS

1. Press the "PRESET KEY" field on the screen.

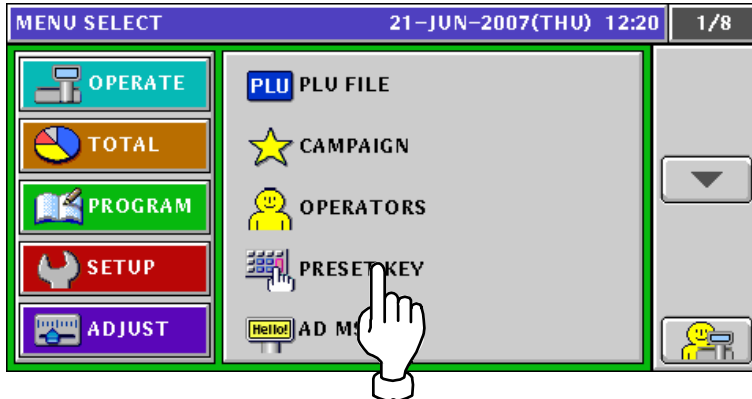

2. The Preset Key (Panel) screen appears.

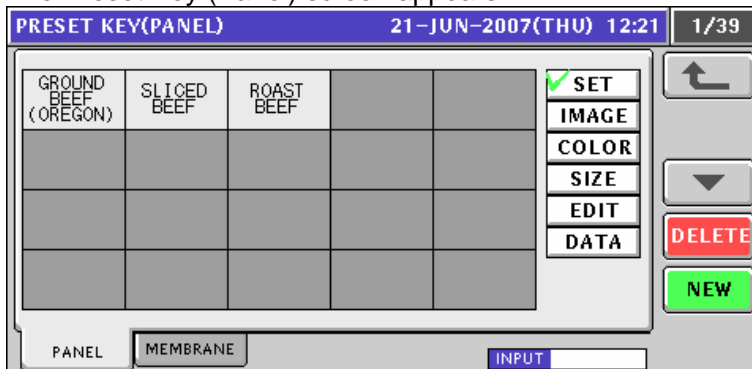

3. Press the [IMAGE] button.

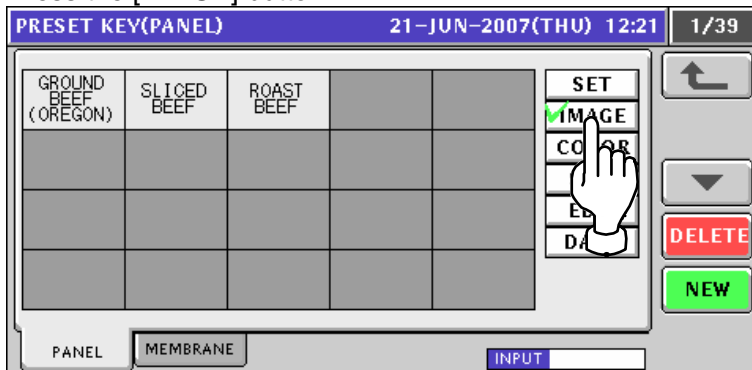

4. Press a desired preset key where the function is already assigned.

EXAMPLE Select "Roast Beef"

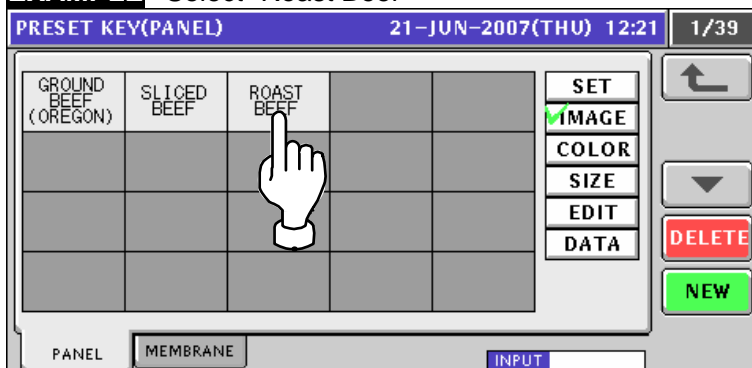

5. The Image List screen appears.

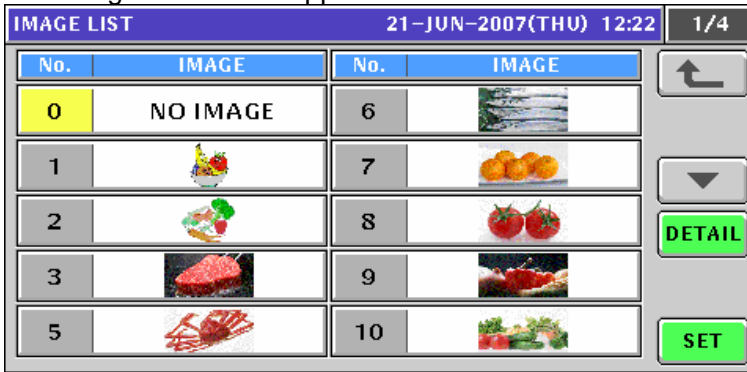

6. Press to select a desired image.

EXAMPLE Image No.3



7. The image has been assigned.

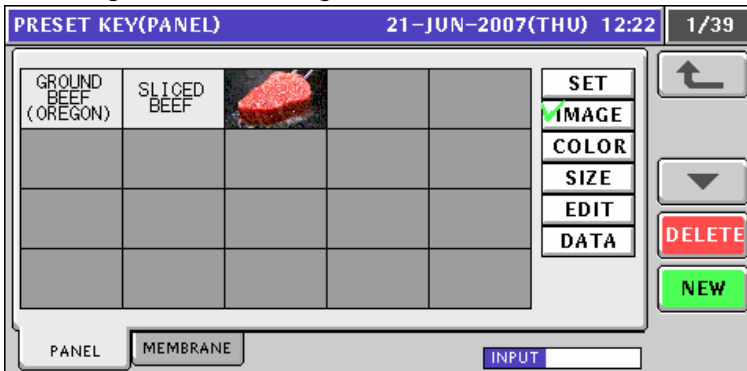

8. Repeat steps 4 through 7 for more registrations.

10.5.3 COLORING PRESET KEYS

1. Press the “PRESET KEY” field on the screen.

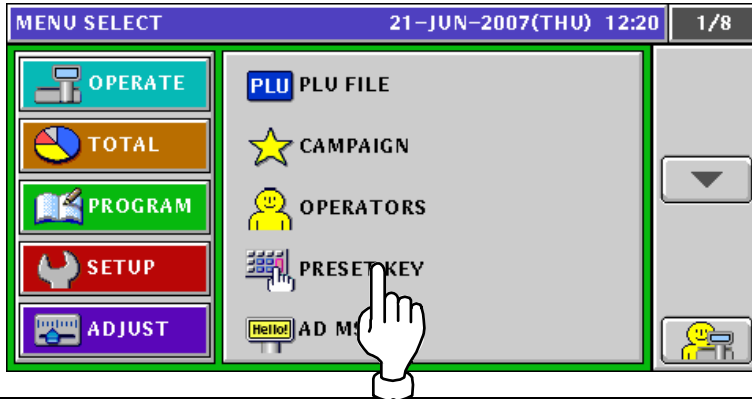

2. The Preset Key (Panel) screen appears.

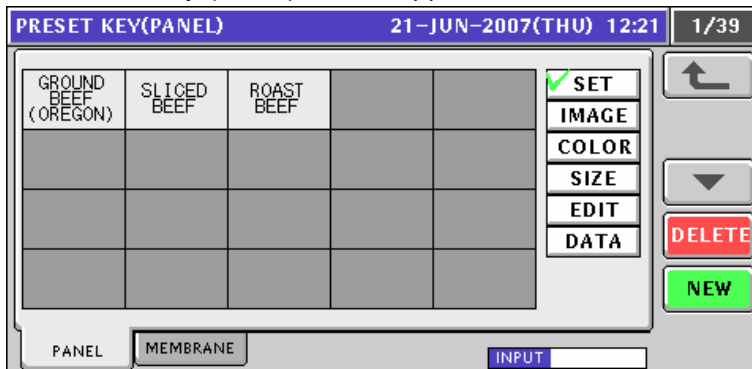

3. Press the [COLOR] button. Then, ensure that “Back Color” is selected.

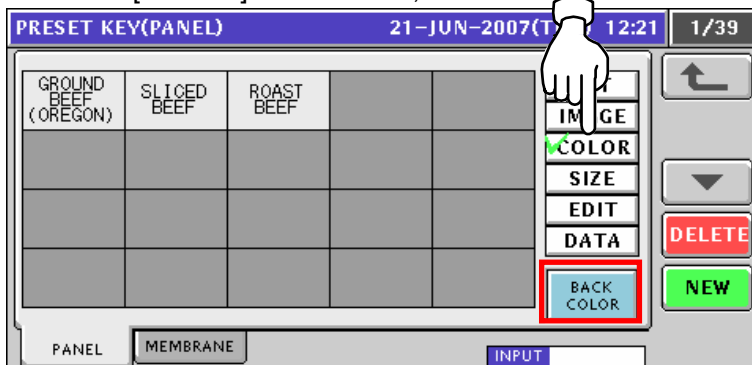

4. Press to select a desired preset key.

EXAMPLE Select “Roast Beef”

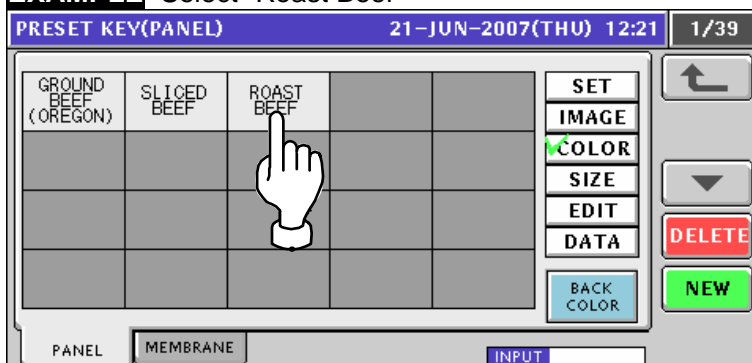

5. The Preset Key (Color) screen appears. Then, press to select a desired color.

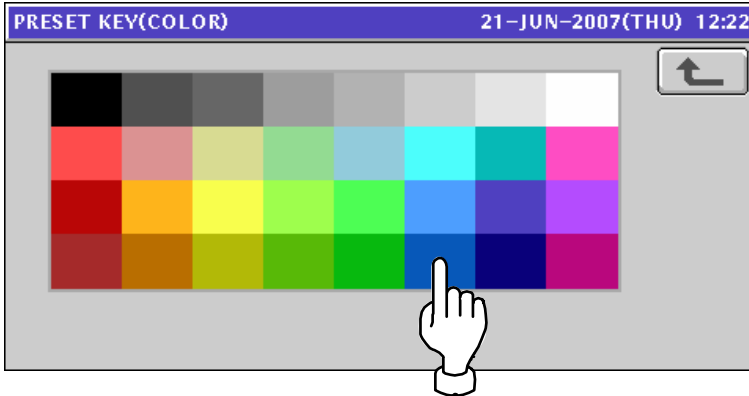

6. Selected color has been given to the background of the key.

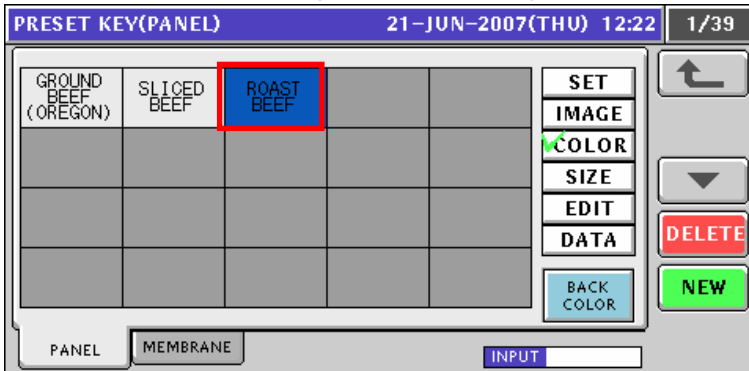

7. Press the [BACK COLOR] button to change to the [FORE COLOR] button.

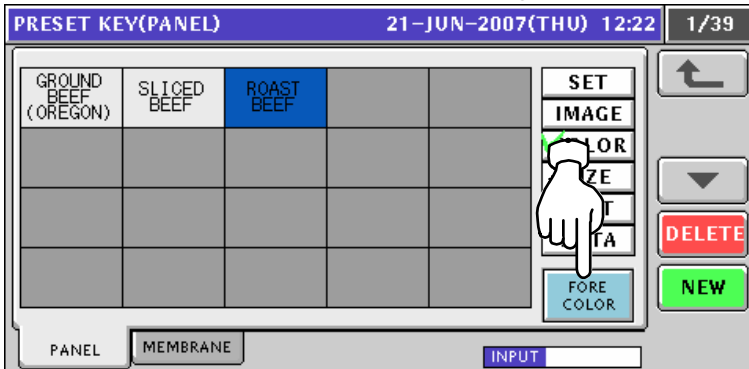

8. Press to select a desired preset key.

EXAMPLE Select "Roast Beef"

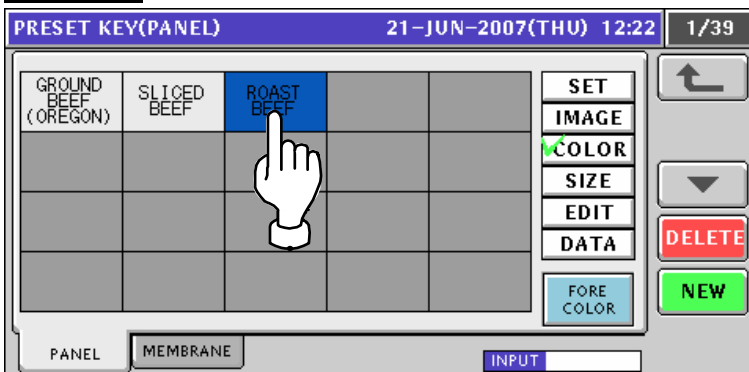

9. The Preset Key (Color) screen appears. Then, press to select a desired color.



10. Selected color has been given to the foreground of the key.

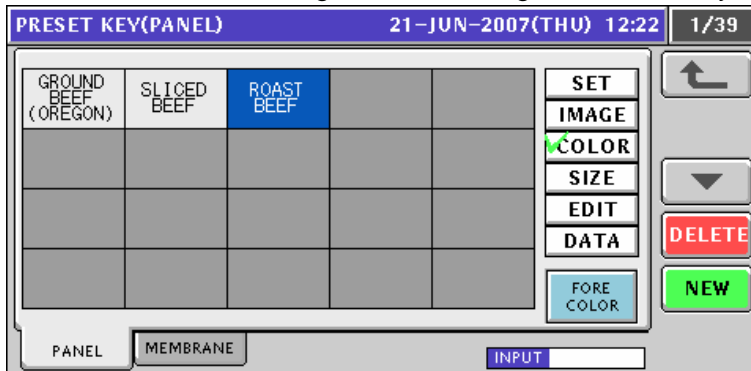

11. Repeat steps 4 through 10 for more registrations.

10.5.4 CHANGING PRESET KEY SIZES

1. Press the "PRESET KEY" field on the screen.

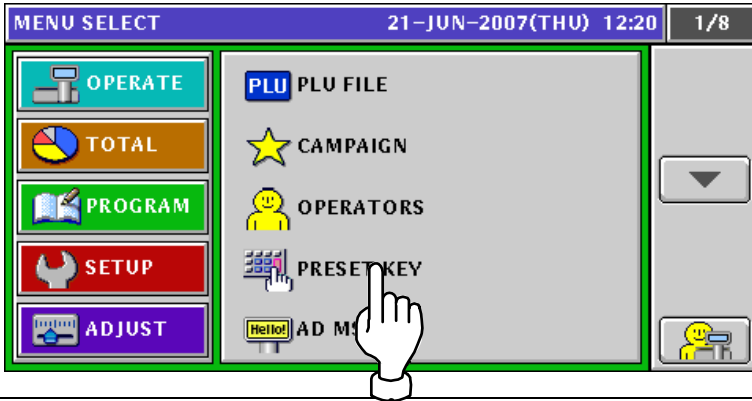

2. The Preset Key (Panel) screen appears.

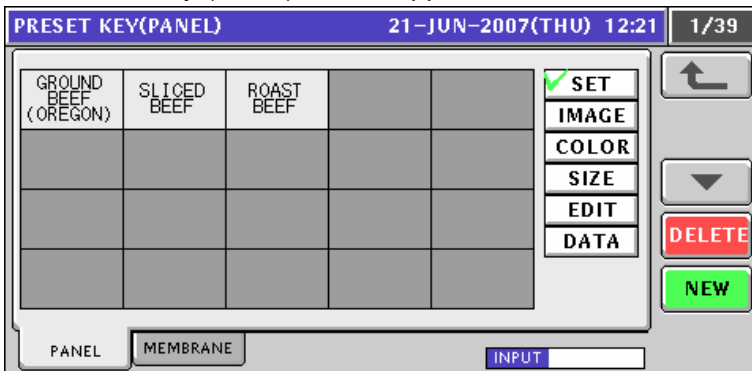

3. Press the [SIZE] button, and ensure that "SMALL" is selected.

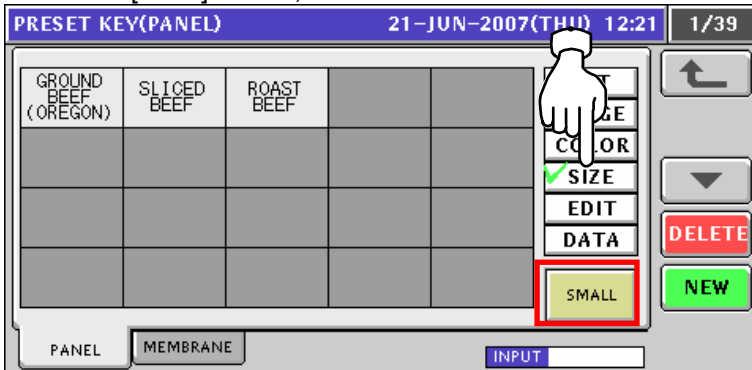

Press the [SMALL] button to change to the [MIDDLE] button.

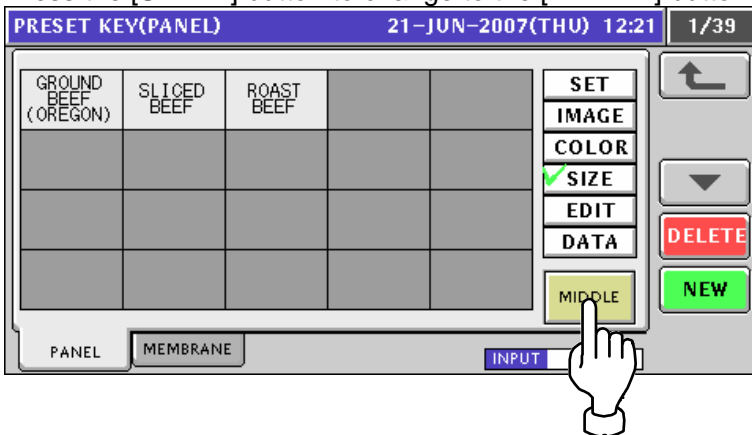

Press the [MIDDLE] button to change to the [LARGE] button.

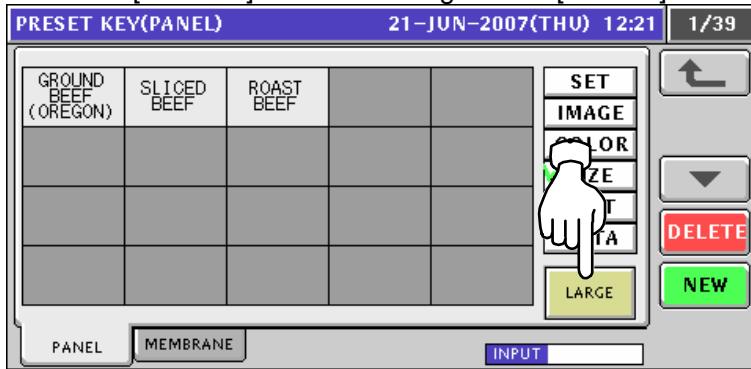

4-1 Change the size of a desired key.

EXAMPLE Change to the middle size of the “Roast Beef” key.

Ensure that the [MIDDLE] button is selected.

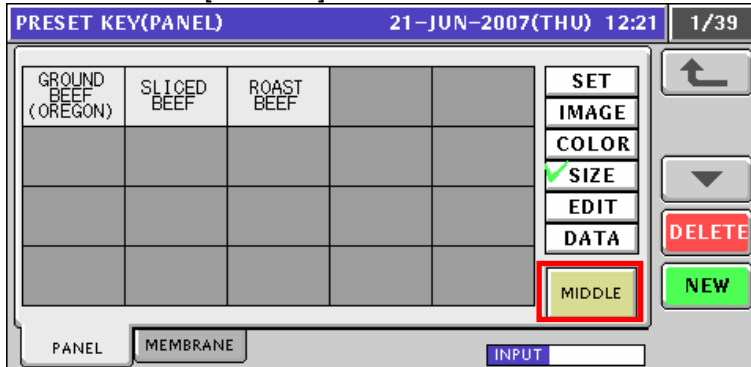

Press the “Roast Beef” key.

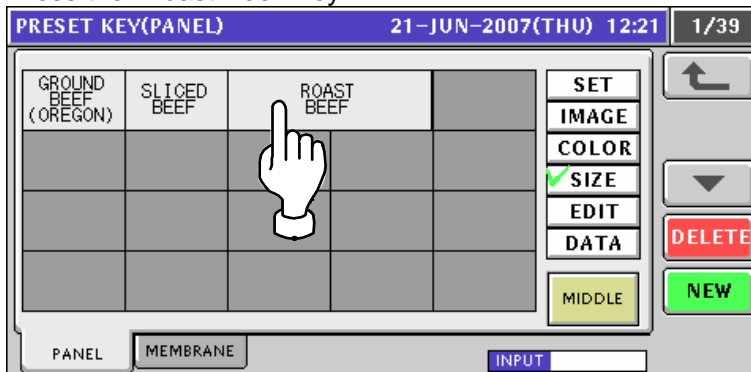

4-2 Change the size of a desired key.**EXAMPLE** Change to the large size of the “Roast Beef” key.

Ensure that the [LARGE] button is selected.

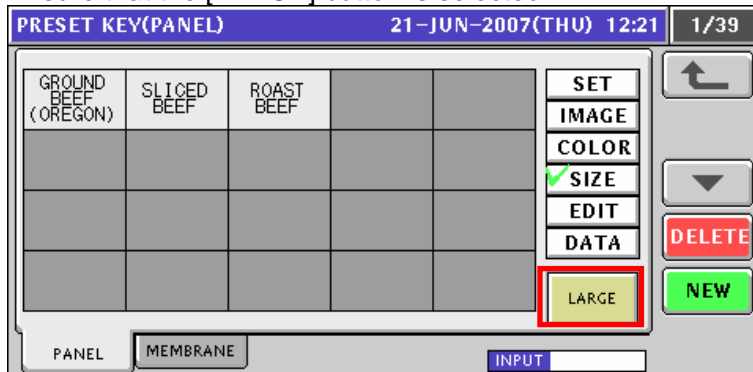

Press the “Roast Beef” key.

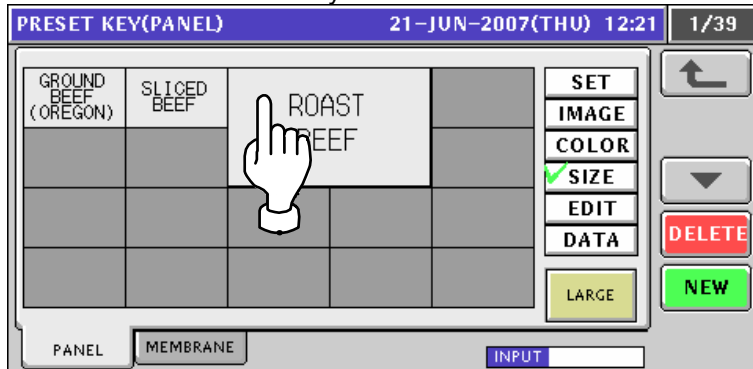
**5.** Repeat steps 3 through 4-2 for more registrations.

10.5.5 EDITING PRESET KEY NAMES

1. Press the "PRESET KEY" field on the screen.

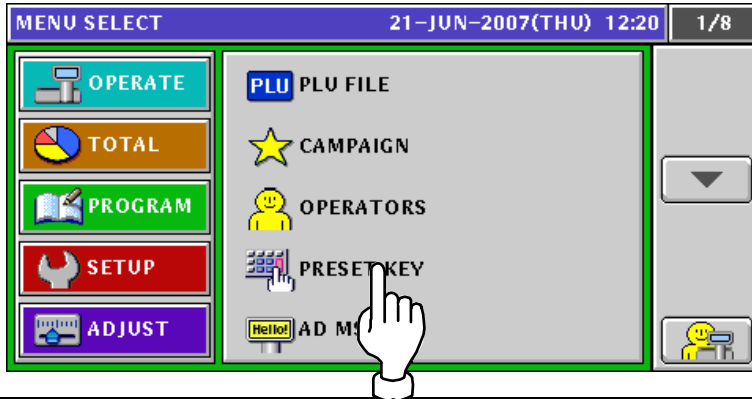

2. The Preset Key (Panel) screen appears.

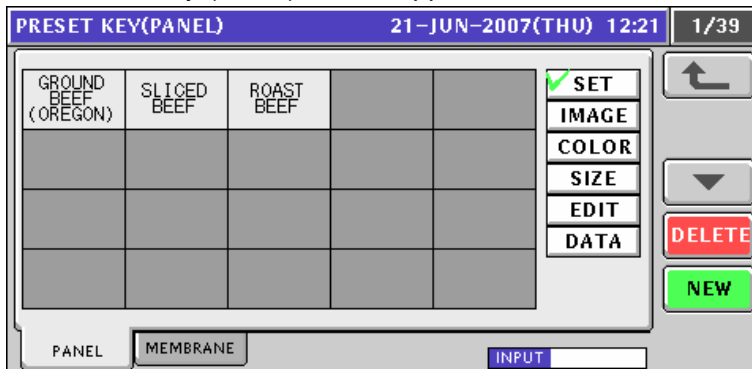

3. Press to select the [EDIT] button.

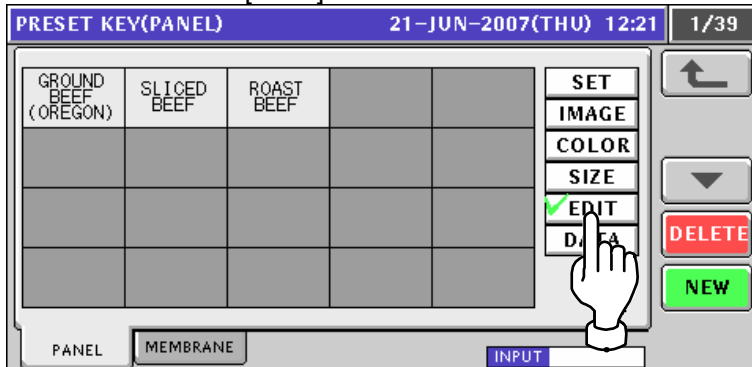

4. Press to select a desired preset key.

EXAMPLE Select the [Roast Beef] key.

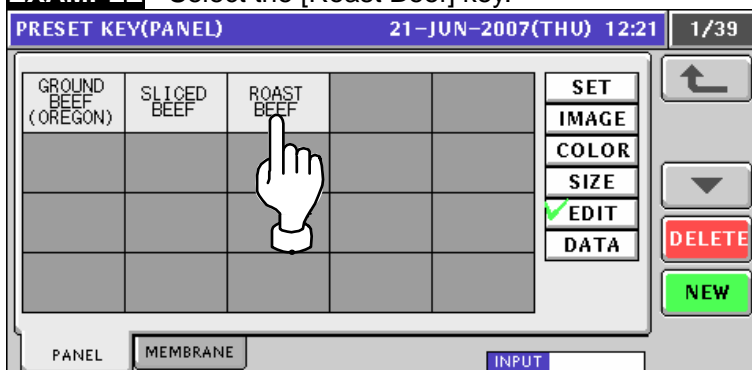

5. The text edit screen appears.

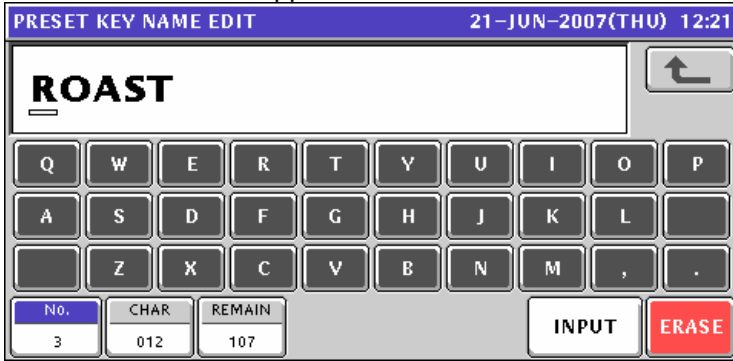

6. Edit a desired text according to the procedures described in Appendix "Text Editing".

EXAMPLE "Beef Fillet".

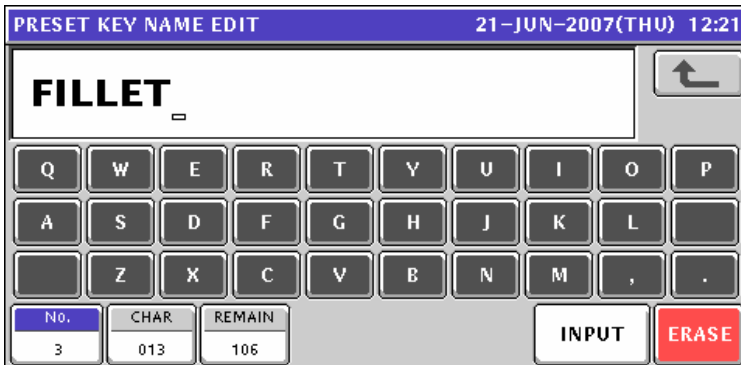
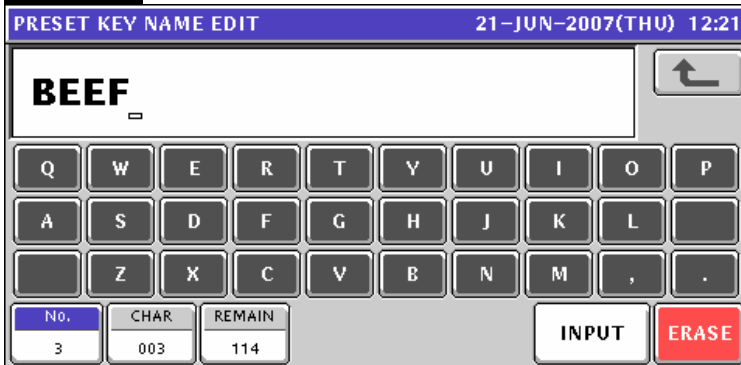

7. To finalize the editing, press the [ESC] key on the key sheet.



The confirmation screen appears. Then, press the [SAVE] button to save the data.

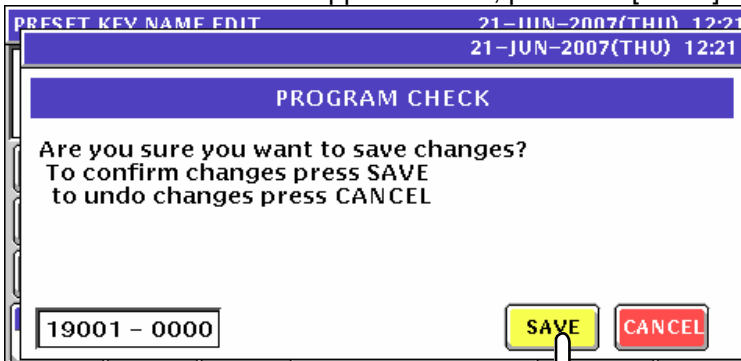

8. The edited text has been registered.

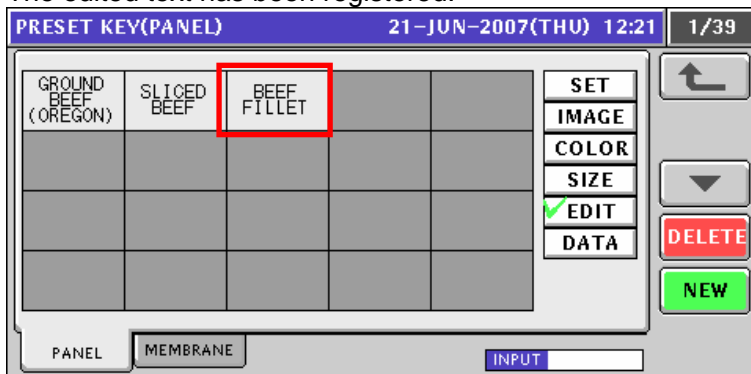

9. Repeat steps 4 through 8 for more registrations.

10.5.6 CONFIRMING PRESET KEY DATA

1. Press the “PRESET KEY” field on the screen.

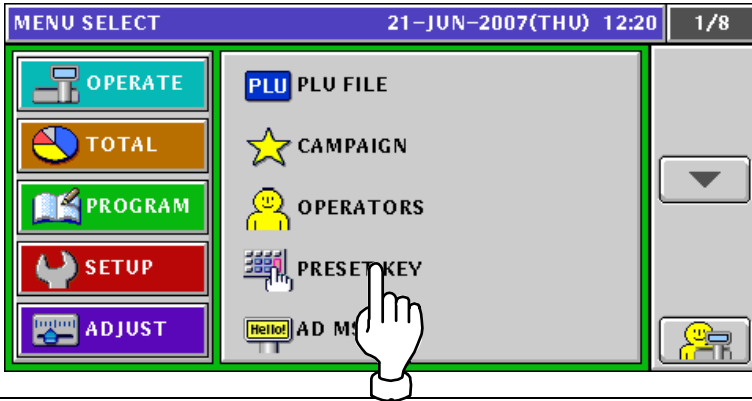

2. The Preset Key (Panel) screen appears.

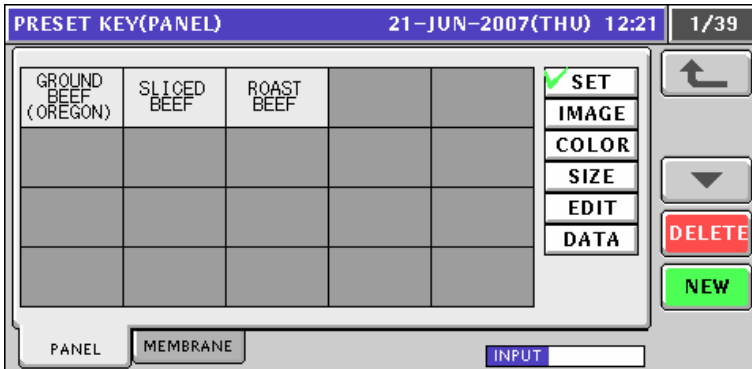

3. Press to select the [DATA] button.

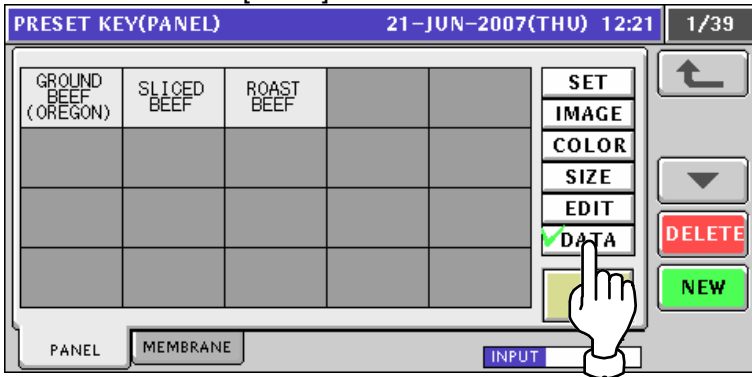

4. Press a desired preset key. The related data is displayed on the button.

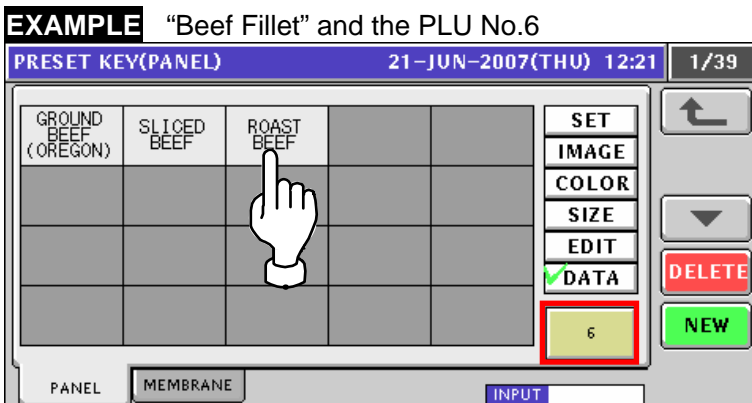

10.5.7 DELETING PRESET KEYS

1. Press the "PRESET KEY" field on the screen.

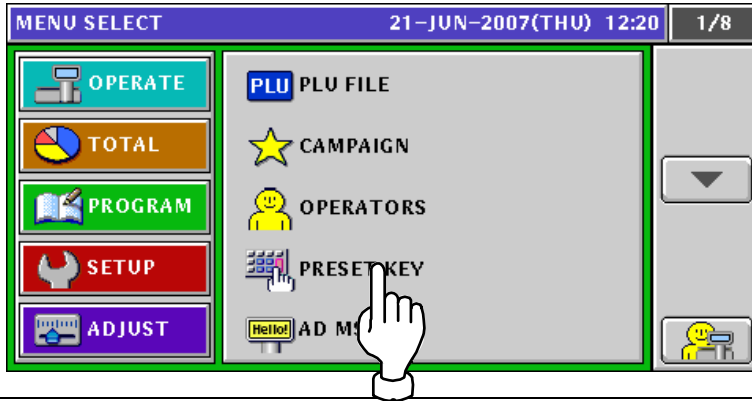

2. The Preset Key (Panel) screen appears. Ensure that the [SET] button is selected.

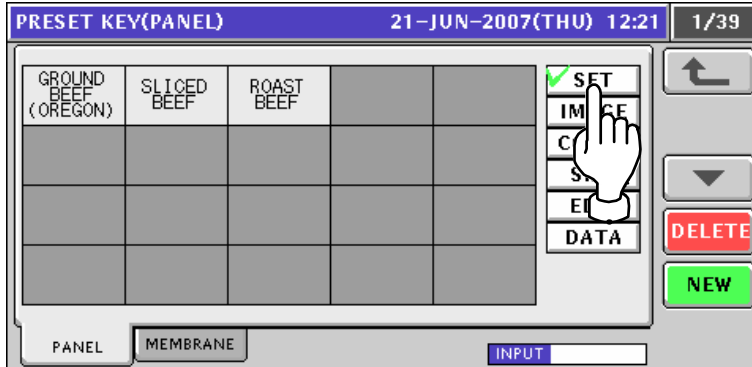

3. Press a desired preset key to be deleted.

EXAMPLE Delete the [Roast Beef] key".

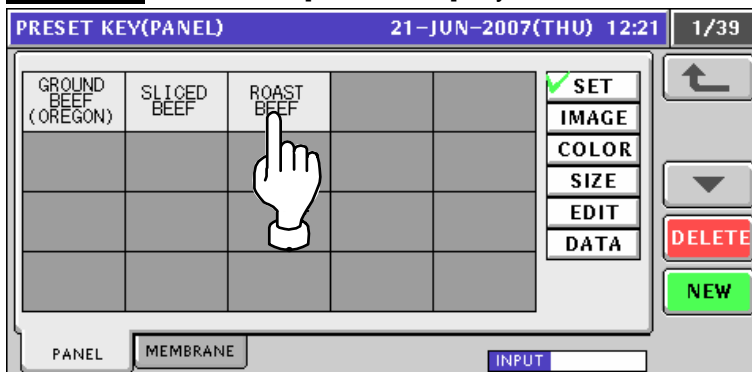

4. The Function List screen appears, and the assigned function field is highlighted.

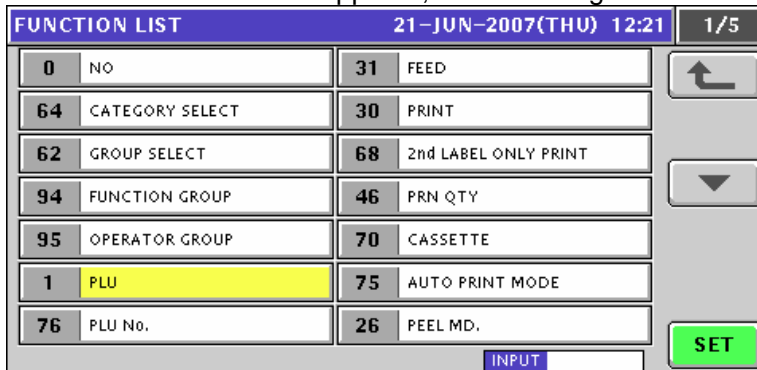

5. Press to select the "NO" field, and press the [SET] button.

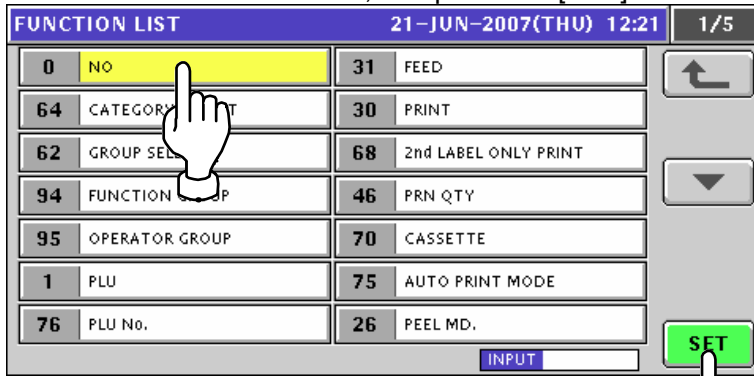

6. The selected key has been deleted.

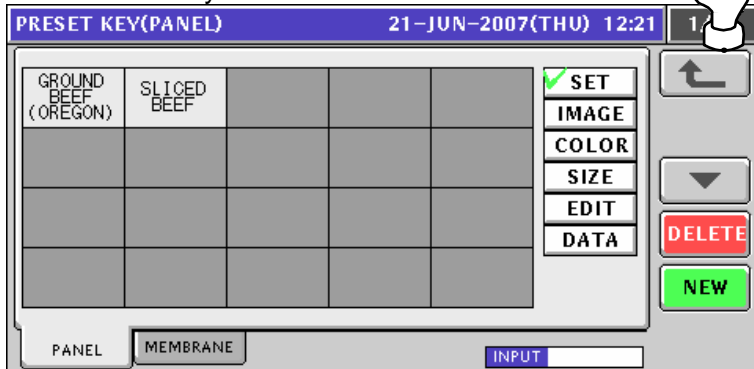

7. Repeat steps 3 through 6 for more deletions.

10.5.8 MEMBRANE KEYS

1. Press the "PRESET KEY" field on the screen.

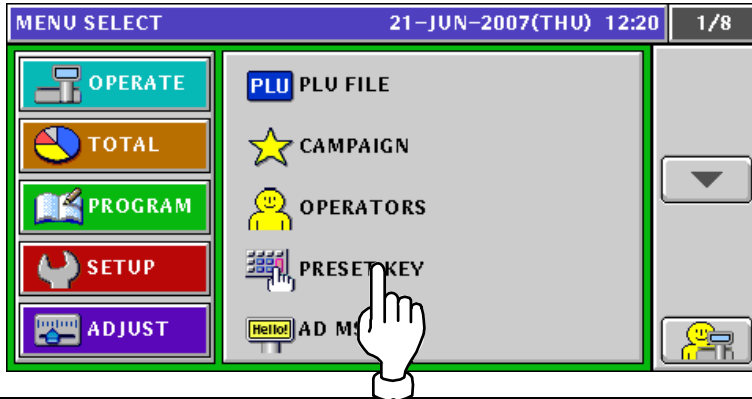

2. The Preset Key (Panel) screen appears. Then, press the [MEMBRANE] tab.

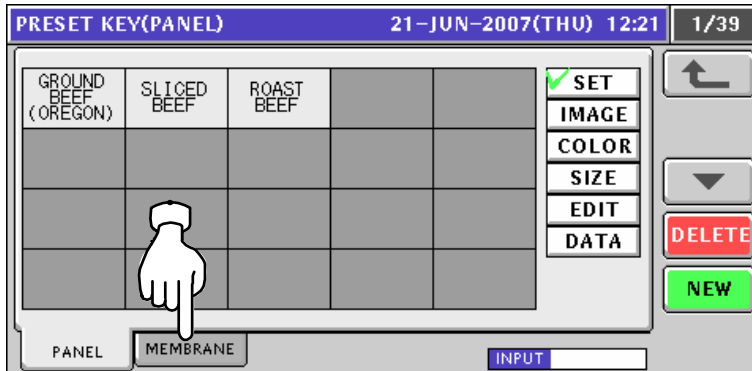

3. The Preset Key (Membrane) screen appears.

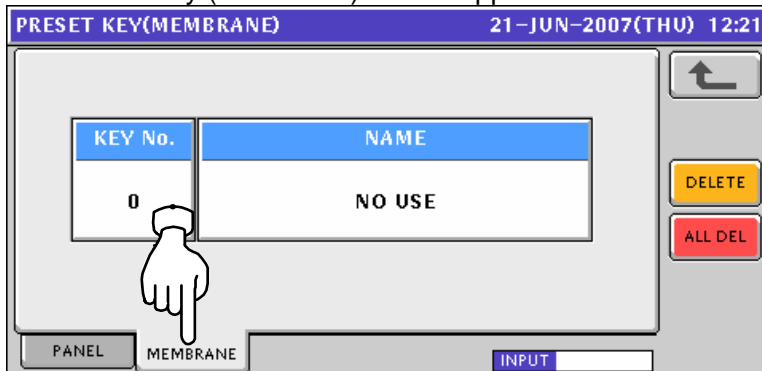

4. Press to select a desired membrane key to which the preset data is assigned.

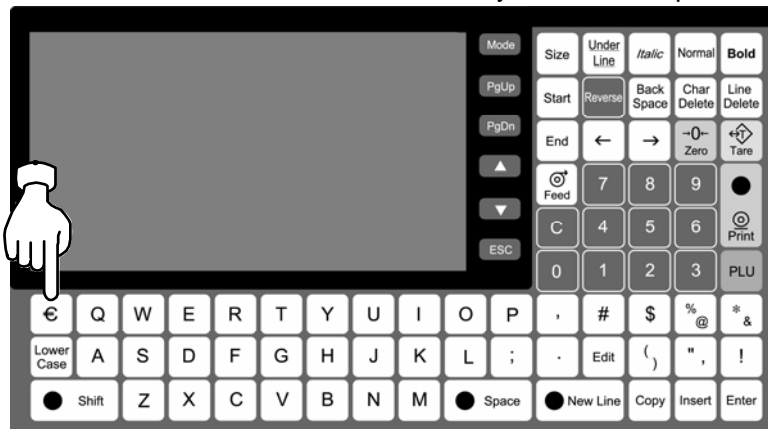

The selected key number and name are shown on the screen.
To assign a desired function to the selected key, press the Name field.

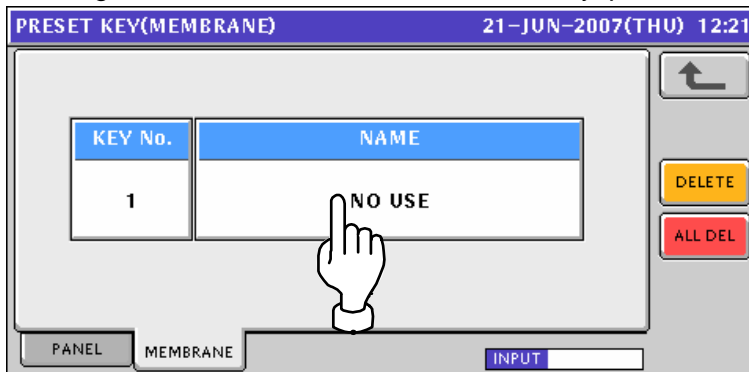

5. The Function List screen appears.

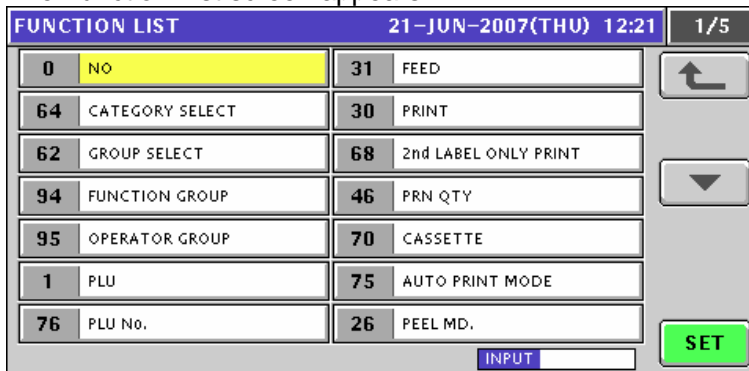

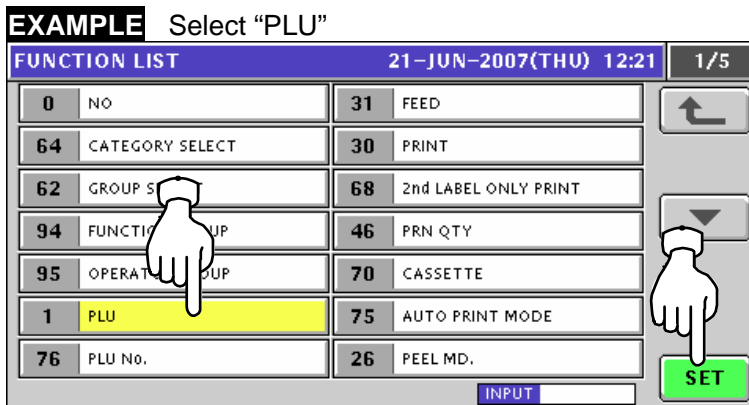

6. Select a desired function to be assigned by pressing the corresponding field, and press the [SET] button.

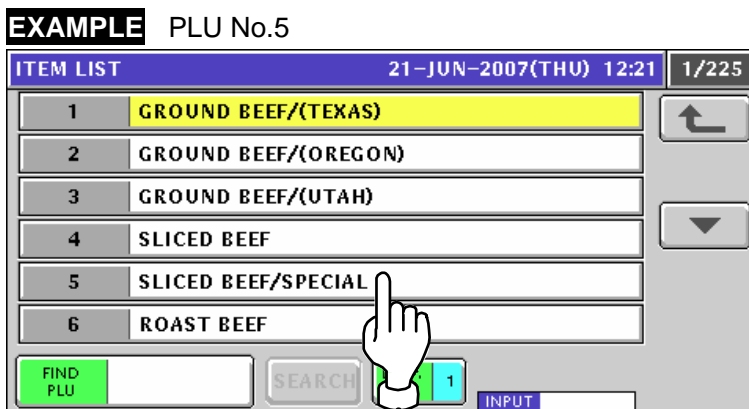

7. The Item List screen appears. Then, press to select a desired field.



8. The selected PLU has been assigned to the selected membrane key.

PRESET KEY(MEMBRANE)		21-JUN-2007(THU) 12:21	
KEY No.	NAME	  	
1	SLICED BEEFSPECIAL (0000005)		
PANEL	MEMBRANE	INPUT	

10.6 ADVERTISEMENT MESSAGE REGISTRATION

1. Press the "AD MSG (Advertisement Message)" field on the Program Menu Select screen.

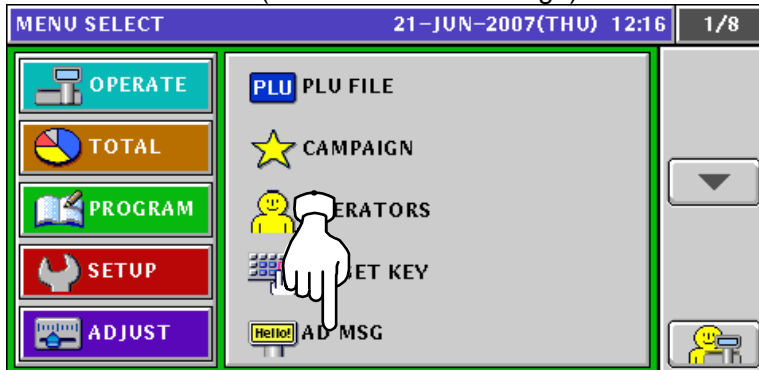

- 2-1 The Advertisement Message List screen appears. When creating the first message, press the [NEW] button.

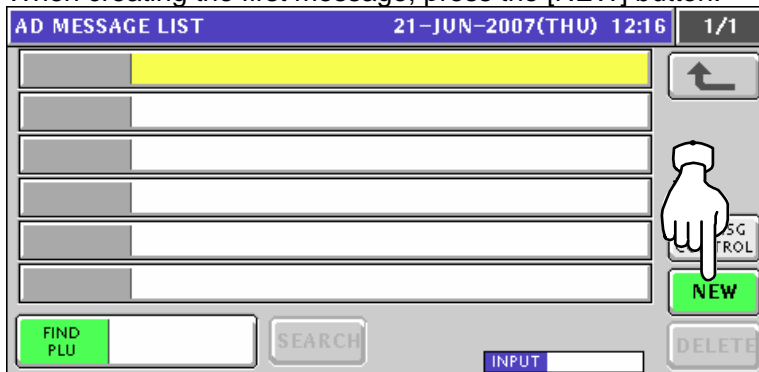

- 2-2 When creating a message other than the first one, enter a desired message number using the numeric keys and press the [PLU] key on the key sheet.

EXAMPLE Message number "2".



3. The confirmation screen appears. Then, press the [ENTER] button.

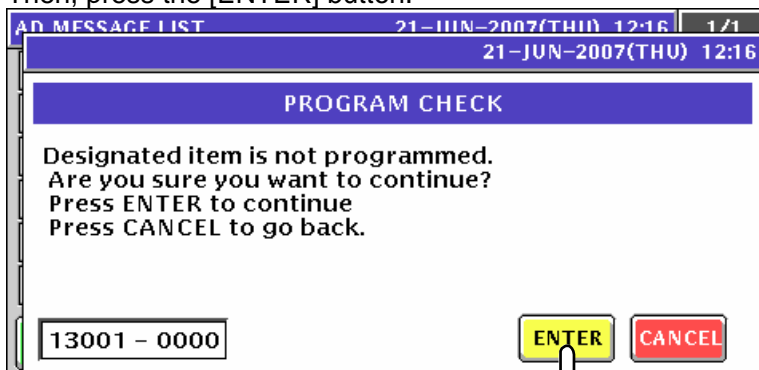

4. The Advertisement Message (Text) screen appears. Then, press the [EDIT] button.

The Advertisement Message Edit screen appears.

No.	CHAR	REMAIN
1	000	060

Edit a desired message according to the procedures described in Appendix "Text Editing".

No.	CHAR	REMAIN
1	014	046

Press the [ESC] key on the key sheet to escape from text editing mode.

ESC

The confirmation screen appears. Then, press the [SAVE] button to save the data.

5. The Advertisement Message (Text) screen for the designated message number appears.

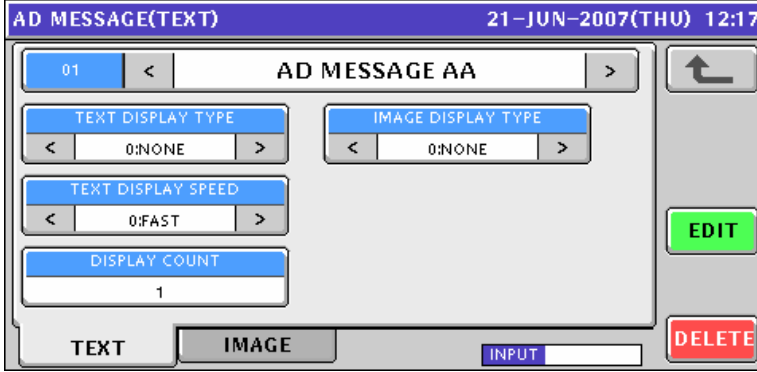

ITEM	DESCRIPTION
TEXT DISPLAY TYPE	Press the [<] or [>] button to select a desired display type.
	0: None
	1: Slide 2: Flash
IMAGE DISPLAY TYPE	Press the [<] or [>] button to select a desired display type.
	0: None
	1: Slide 2: Flash
TEXT DISPLAY SPEED	Press the [<] or [>] button to select a desired display speed.
	0: Fast
	1: Medium 2: Slow
DISPLAY COUNT	Enter a display count data and press this field.

6. Press the [IMAGE] tab. Then, the Advertisement Message (Image) screen appears.

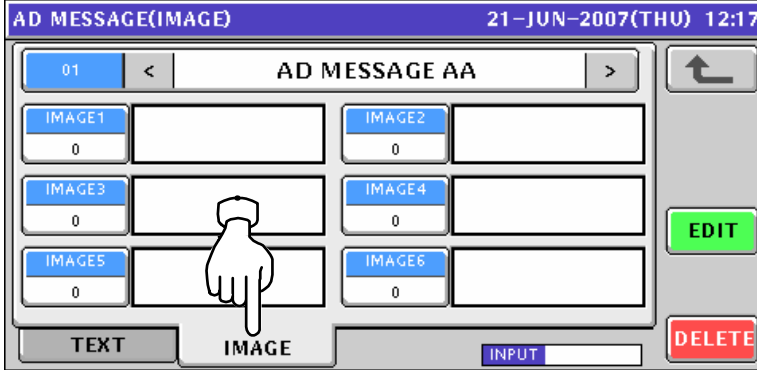

7. When setting an image, press a desired field.

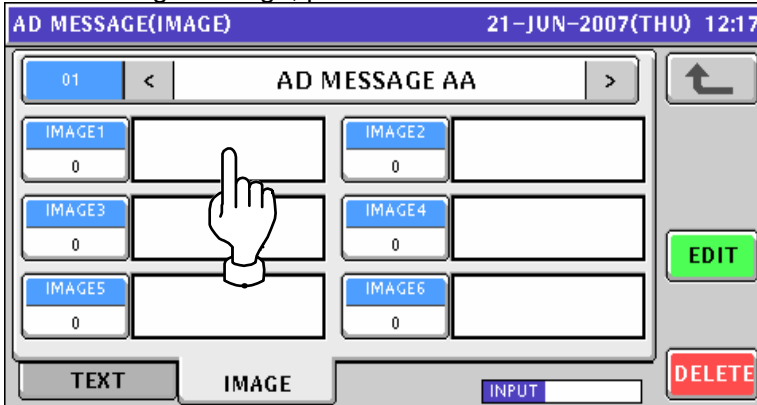

8. The Image List appears.

IMAGE LIST				21-JUN-2007(THU) 12:17		1/4
No.	IMAGE	No.	IMAGE			
0	NO IMAGE	6		<input type="button" value="↑"/> <input type="button" value="↓"/> <input type="button" value="DETAIL"/> <input type="button" value="SET"/>		
1		7				
2		8				
3		9				
5		10				

9. Press to select a desired field and press the [SET] button.

IMAGE LIST				21-JUN-2007(THU) 12:17		1/4
No.	IMAGE	No.	IMAGE			
0	NO IMAGE	6		<input type="button" value="↑"/> <input type="button" value="↓"/> <input type="button" value="DETAIL"/> <input type="button" value="SET"/>		
1		7				
2		8				
3		9				
5		10				

The selected image has been assigned in the designated field.

AD MESSAGE (IMAGE)				21-JUN-2007(THU) 12:18		
01	<	AD MESSAGE AA	>	<input type="button" value="↑"/> <input type="button" value="EDIT"/> <input type="button" value="DELETE"/>		
IMAGE1	3		IMAGE2			0
IMAGE3	0		IMAGE4			0
IMAGE5	0		IMAGE6			0
TEXT		IMAGE				INPUT

10. Repeat steps 7 through 9 for more registrations.
Then, press the Return button to finalize this procedure.
The edited message has been registered.

AD MESSAGE LIST				21-JUN-2007(THU) 12:19		1/1
1	AD MESSAGE AA			<input type="button" value="↑"/> AD MSG CONTROL <input type="button" value="DETAIL"/> <input type="button" value="DELETE"/>		
FIND PLU	SEARCH	INPUT				

10.7 STORE NAME REGISTRATION

10.7.1 CHANGING EXISTING STORE DATA

1. Press the "STORE NAME" field on the Program Menu Select screen.

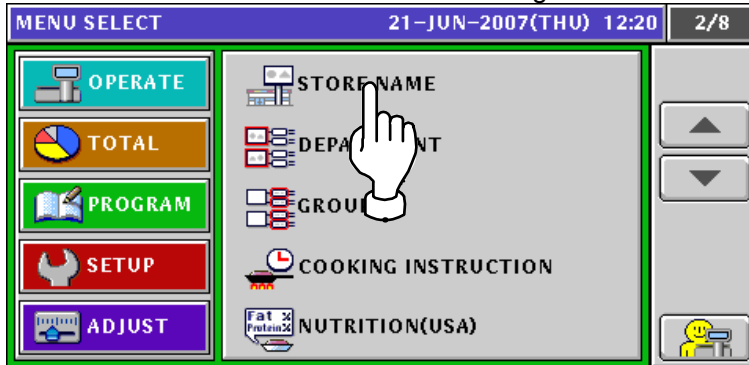

2. The default store data screen appears. When changing the store data, press the [EDIT] button.

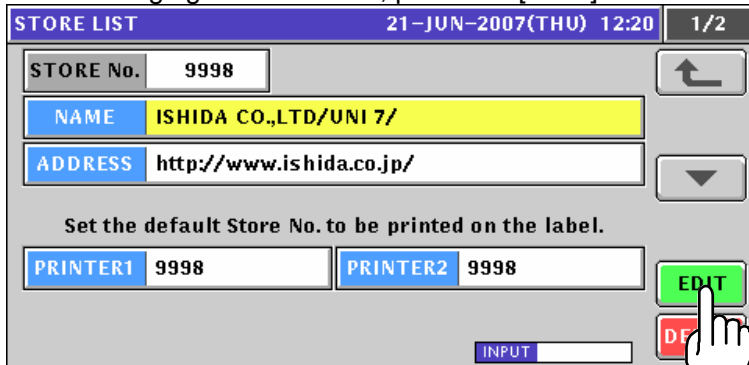

3. The Store Name Edit screen appears.



4. Edit a text according to the procedures described in Appendix "Text Editing".

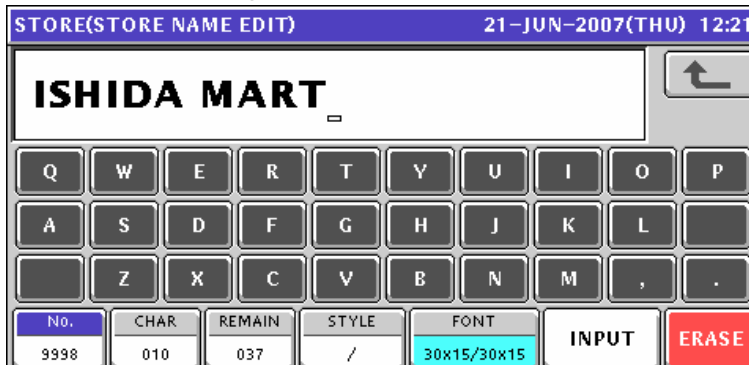

5. Press the [ESC] key on the key sheet to escape from text editing mode.

ESC

The confirmation screen appears. Then, press the [SAVE] button.

6. The store name has been changed.

7. Press to select the address field line and press the [EDIT] button.

8. The Store Address Edit screen appears.

9. Edit a text according to the procedures described in Appendix "Text Editing".

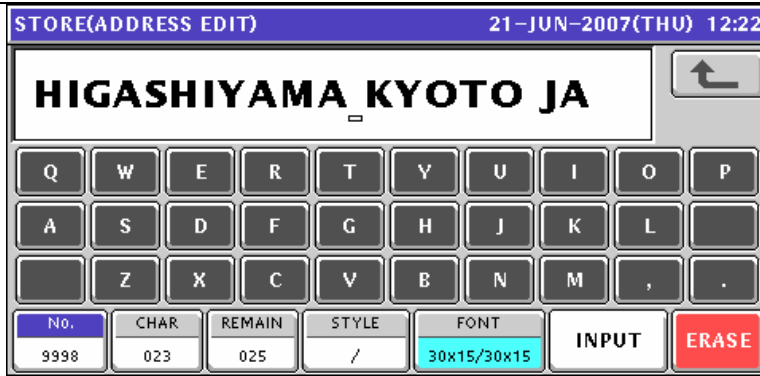

10. Press the [ESC] key on the key sheet to escape from text editing mode.



The confirmation screen appears. Then, press the [SAVE] button.

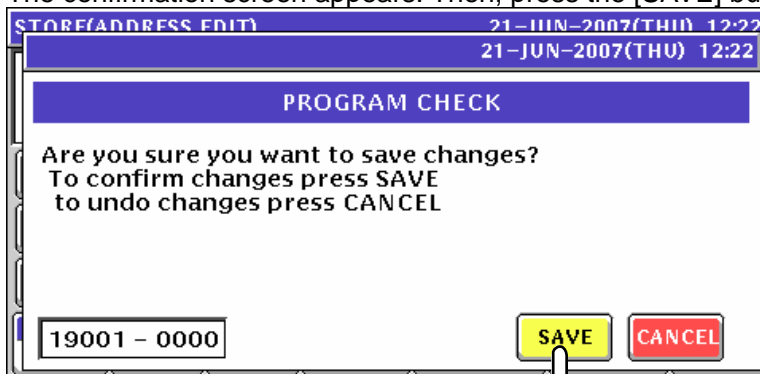

11. The store address has been changed.



10.7.2 CREATING NEW STORE DATA

1. Press the "STORE NAME" field on the Program Menu Select screen.

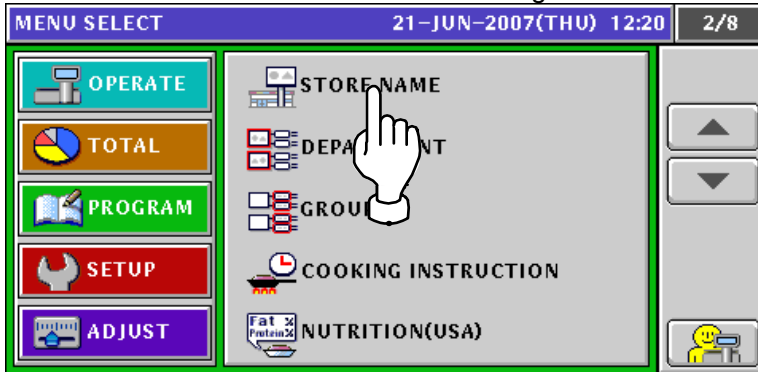

2. The default store data screen appears.

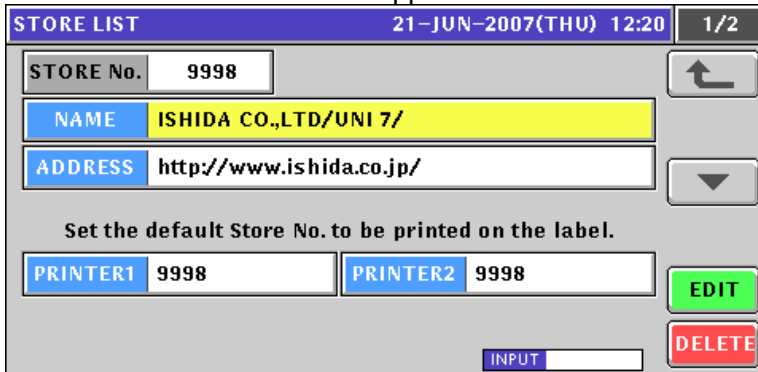

3. When creating a new store data, enter the desired store number and press the [PLU] key.

EXAMPLE Store number "1"



The confirmation screen appears. Then, press the [ENTER] button.

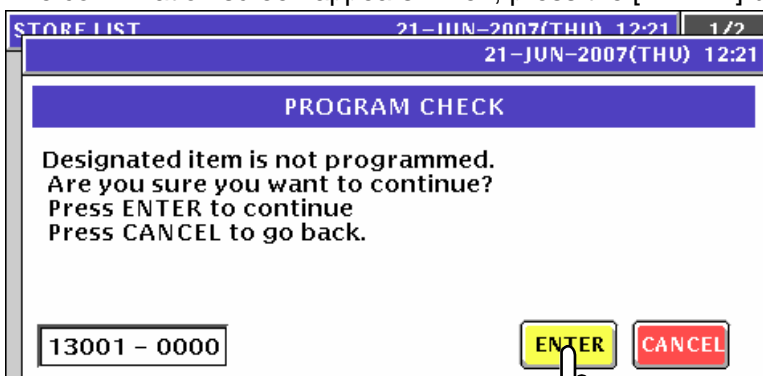

4. The Store Name Edit screen appears for the selected store number.



5. Edit a text according to the procedures described in Appendix "Text Editing".



6. Press the [ESC] key on the key sheet to escape from text editing mode.



The confirmation screen appears. Then, press the [SAVE] button.

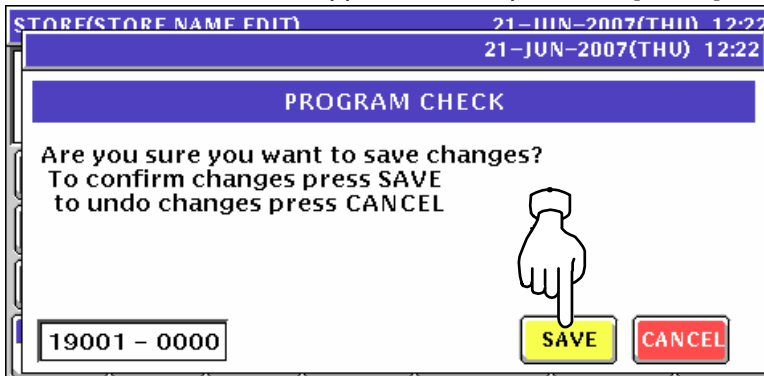

7. The store name has been registered

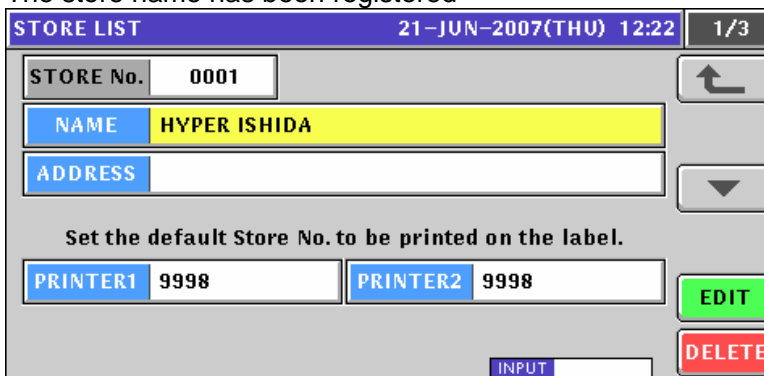

8. Press to select the “Address” field and press the [EDIT] button.

STORE LIST 21-JUN-2007(THU) 12:22 1/3

STORE No. 0001

NAME HYPER ISHIDA

ADDRESS

Set the default Store No. to [] entered on the label.

PRINTER1 9998 PRINTER2 9998

EDIT

INPUT

9. The Store Address Edit screen appears.

STORE(AADDRESS EDIT) 21-JUN-2007(THU) 12:22

Q W E R T Y U I O P

A S D F G H J K L

Z X C V B N M , .

No.	CHAR	REMAIN	STYLE	FONT	INPUT	ERASE
1	000	048	/	30x15/30x15	INPUT	ERASE

10. Edit a text according to the procedures described in Appendix “Text Editing”.

STORE(AADDRESS EDIT) 21-JUN-2007(THU) 12:23

BIWAKO SHIGA JAPAN

Q W E R T Y U I O P

A S D F G H J K L

Z X C V B N M , .

No.	CHAR	REMAIN	STYLE	FONT	INPUT	ERASE
1	018	030	/	30x15/30x15	INPUT	ERASE

11. Press the [ESC] key on the key sheet to escape from text editing mode.



The confirmation screen appears. Then, press the [SAVE] button.

STORE(AADDRESS EDIT) 21-JUN-2007(THU) 12:23



PROGRAM CHECK

Are you sure you want to save changes?
To confirm changes press SAVE
to undo changes press CANCEL

19001 - 0000

SAVE CANCEL



12. The store address has been registered.

STORE LIST		21-JUN-2007(THU) 12:23	1/3
STORE No.	0001		
NAME	HYPER ISHIDA		
ADDRESS	BIWAKO SHIGA JAPAN		
Set the default Store No. to be printed on the label.			
PRINTER1	9998	PRINTER2	9998
			
			
<input type="text" value="INPUT"/>			

13. Enter a desired store number as a default store data and press the "Printer 1" or "Printer 2" display field.

EXAMPLE Set the store number "1" for printer #1.

1

STORE LIST		21-JUN-2007(THU) 12:23	1/3
STORE No.	0001		
NAME	HYPER ISHIDA		
ADDRESS	BIWAKO SHIGA JAPAN		
Set the default Store No. to be printed on the label.			
PRINTER1	0001	PRINTER2	9998
			
			
<input type="text" value="INPUT"/>			



10.8 DEPARTMENT NAME REGISTRATION

10.8.1 CREATING NEW DEPARTMENT NAMES

1. Press the "Department" field on the Program Menu Select screen.



2. The Department List screen appears. Then, press the [NEW] button.

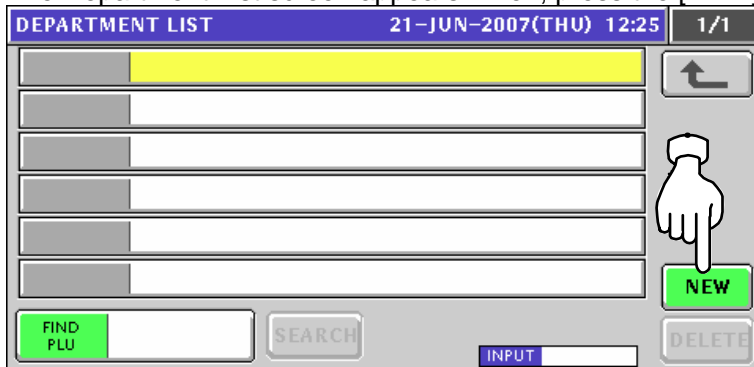

3. The confirmation screen appears. Then, press the [ENTER] button.

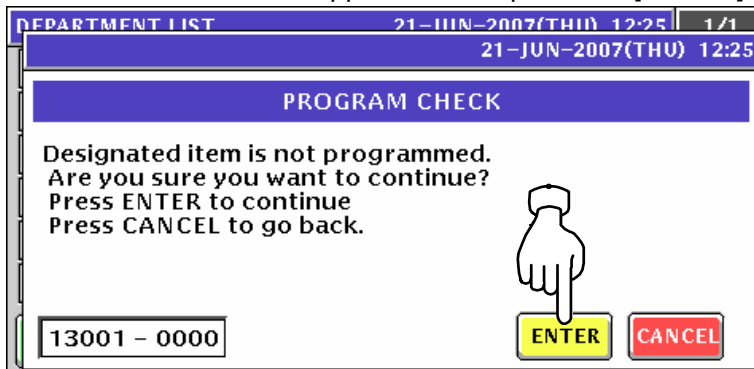

4. The Department Name Edit screen appears.



5. Edit a text according to the procedures described in Appendix “Text Editing”.

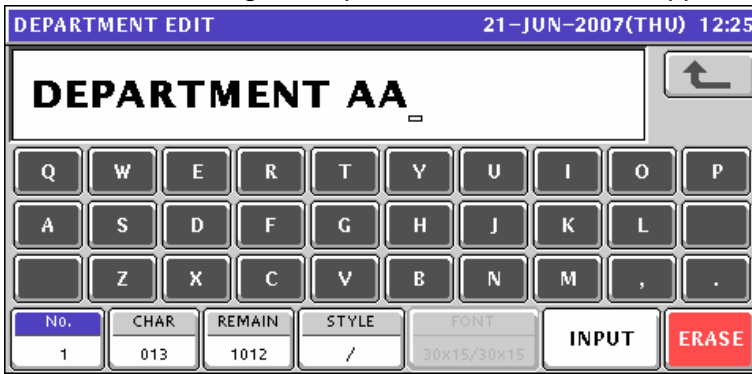

6. Press the [ESC] key on the key sheet to escape from text editing mode.



The confirmation screen appears. Then, press the [SAVE] button.

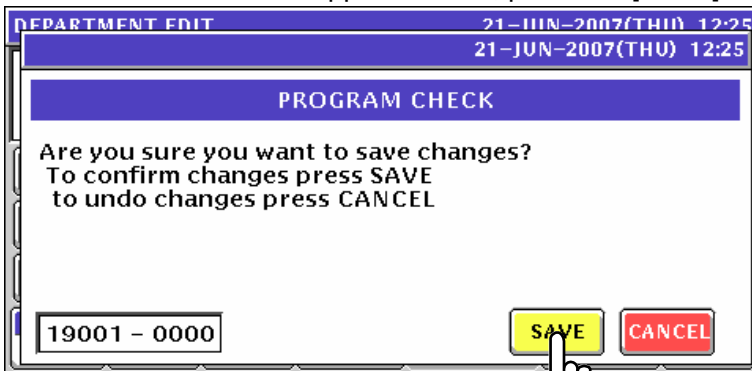

7. The edited text has been registered.

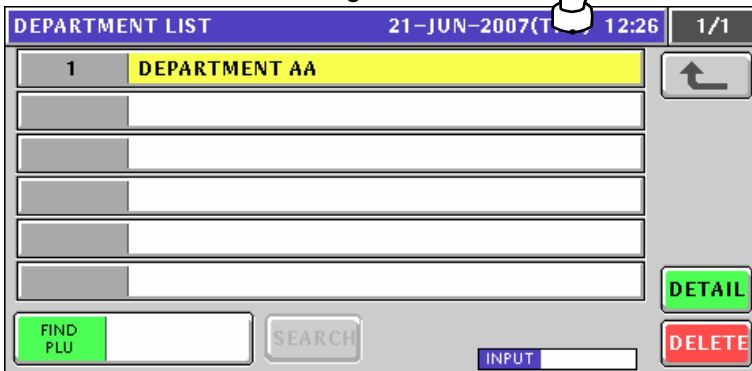

8. When creating more department names, enter a desired department number using the numeric keys and press the [PLU] key on the key sheet.

EXAMPLE Department number “2”.

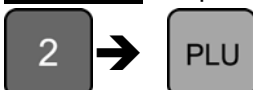

The confirmation screen appears. Then, press the [ENTER] button.

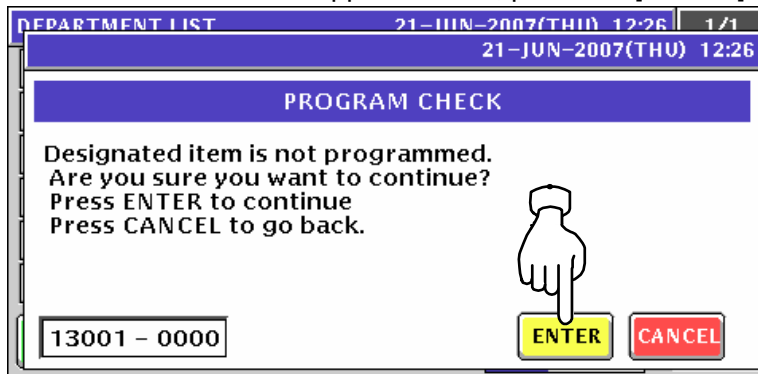

9. The Department Name Edit screen appears.

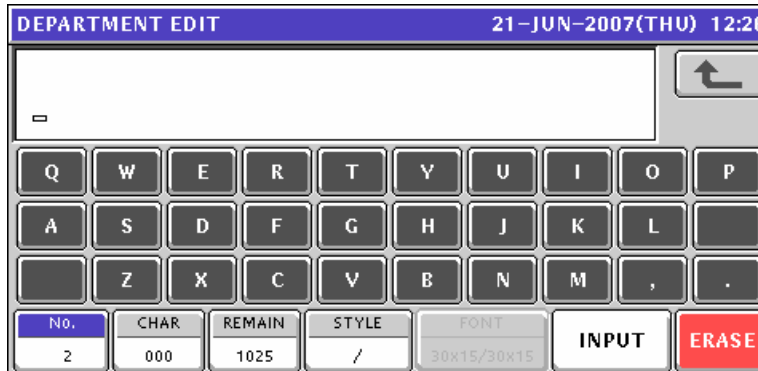

10. Edit a text according to the procedures described in Appendix "Text Editing".

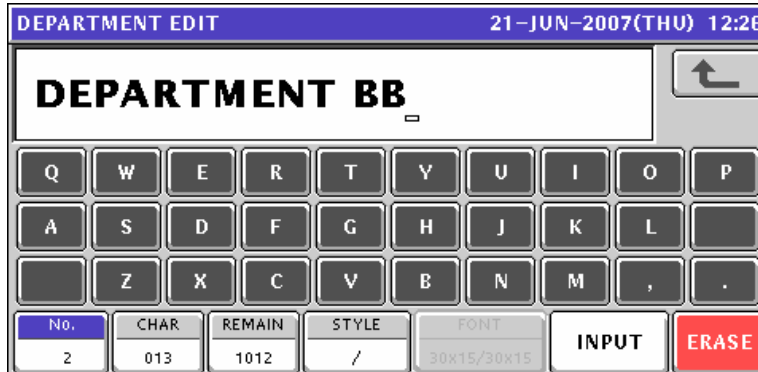

11. Press the [ESC] key on the key sheet to escape from text editing mode.

ESC

The confirmation screen appears. Then, press the [SAVE] button.

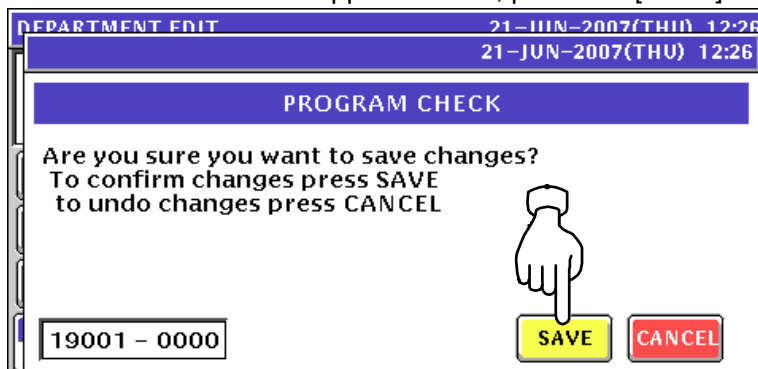

12. The edited text has been registered.

DEPARTMENT LIST		21-JUN-2007(THU) 12:26	1/1
1	DEPARTMENT AA		
2	DEPARTMENT BB		

FIND PLU SEARCH INPUT DETAIL DELETE

13. Repeat steps 8 through 12 for more registrations.

10.8.2 CHANGING EXISTING DEPARTMENT NAMES

1. Press the "Department" field on the Program Menu Select screen.



2. The Department List screen appears.

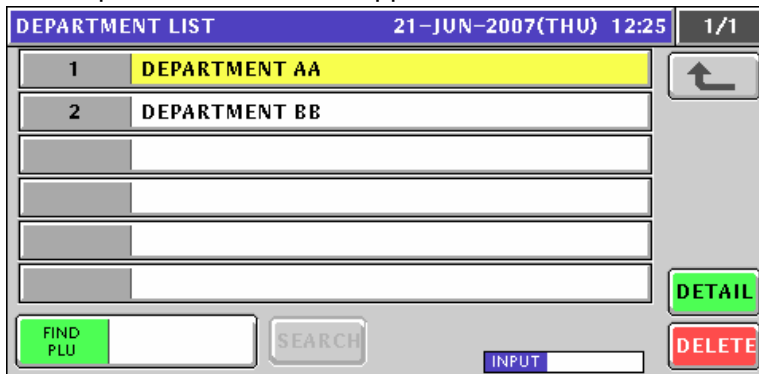

3. When changing an existing data, press to select a desired field.

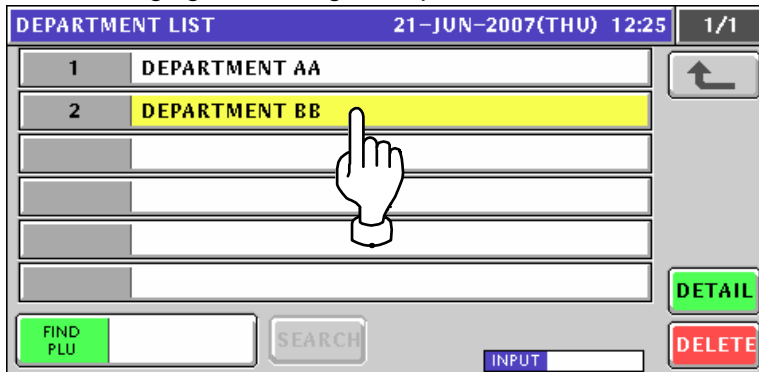

4. The Department Name Edit screen appears for the selected department.



5. Edit a text according to the procedures described in Appendix “Text Editing”.



6. Press the [ESC] key on the key sheet to escape from text editing mode.



The confirmation screen appears. Then, press the [SAVE] button.

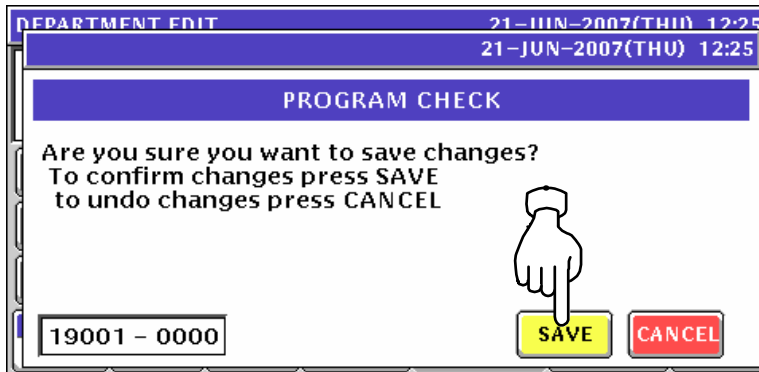

7. The edited text has been registered.

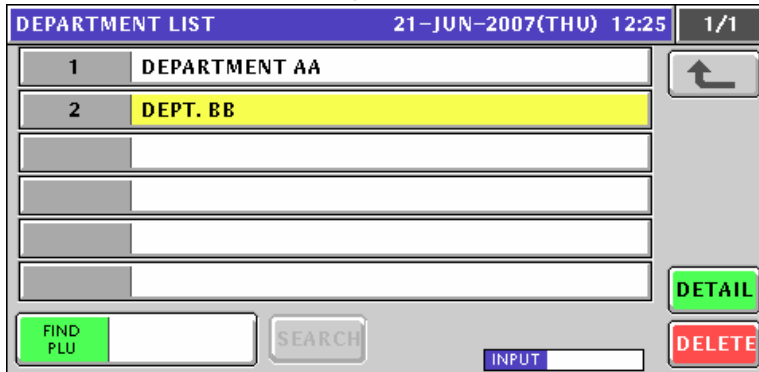

8. Repeat steps 3 through 7 for more registrations.

10.9 GROUP NAME REGISTRATION

10.9.1 CREATING NEW GROUP NAMES

1. Press the "Group" field on the Program Menu Select screen.



2. The Group List screen appears. Then, press the [NEW] button.

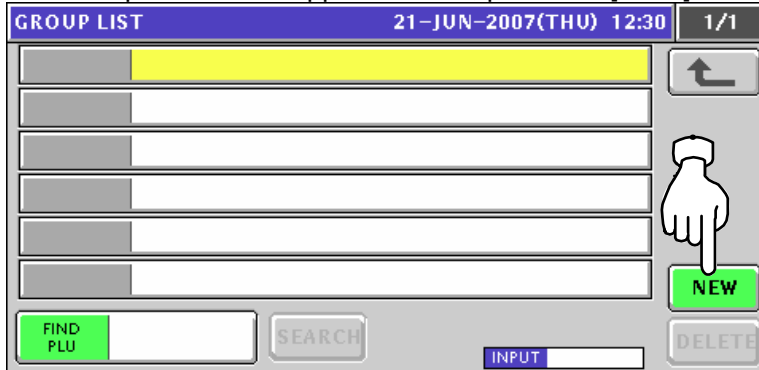

3. The confirmation screen appears. Then, press the [ENTER] button.

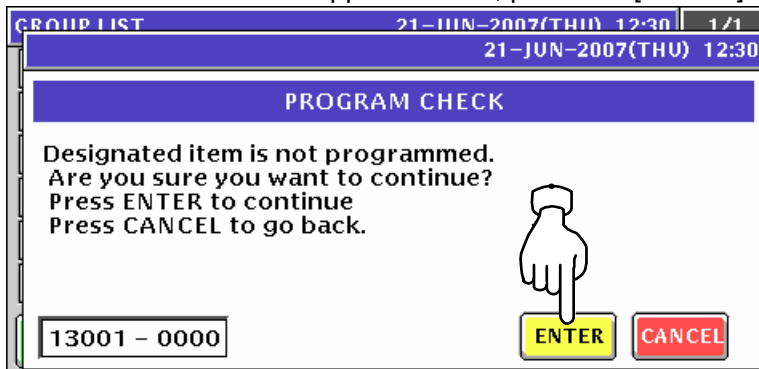

4. The Group Name Edit screen appears.

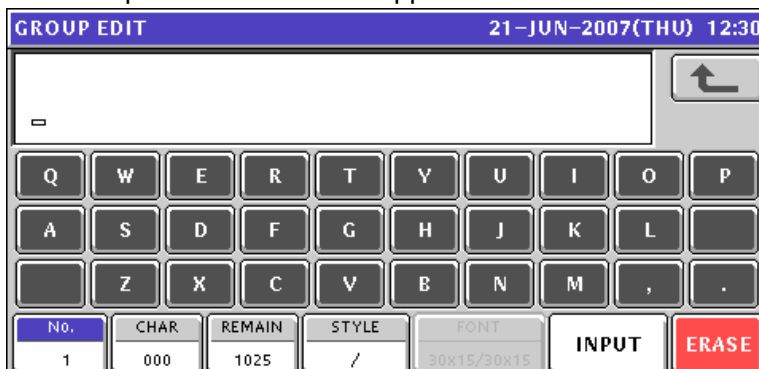

5. Edit a text according to the procedures described in Appendix “Text Editing”.

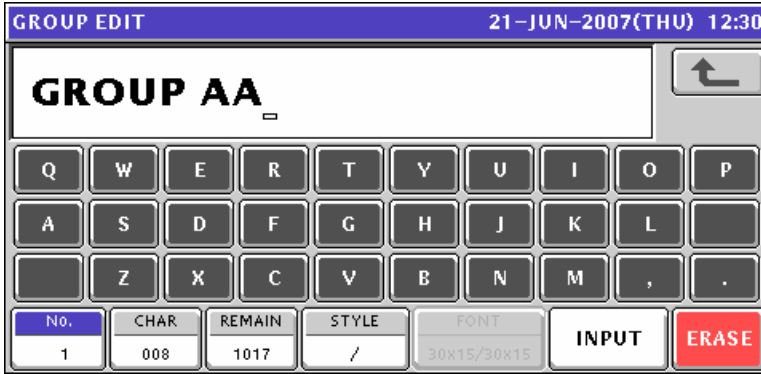

6. Press the [ESC] key on the key sheet to escape from text editing mode.



The confirmation screen appears. Then, press the [SAVE] button.

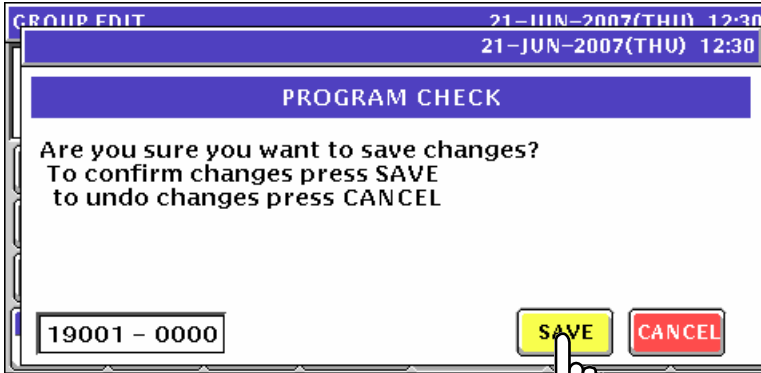

7. The edited text has been registered.

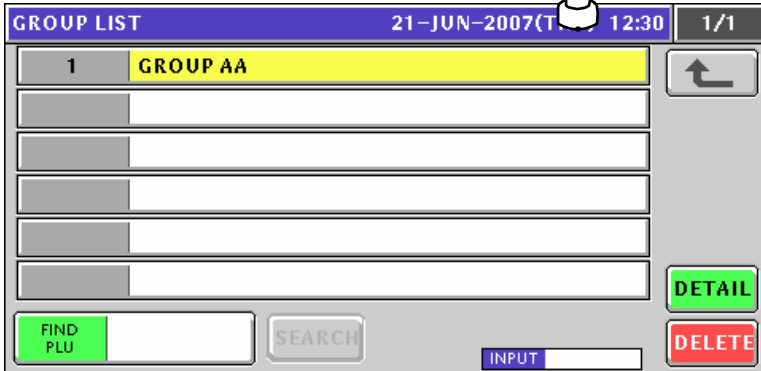

8. When creating more group names, enter a desired group number using the numeric keys and press the [PLU] key on the key sheet.

EXAMPLE Group number “2”.

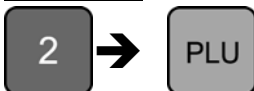

The confirmation screen appears. Then, press the [ENTER] button.

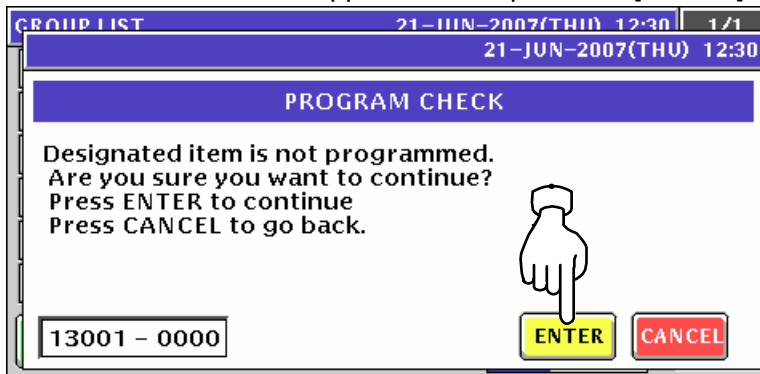

9. The Group Name Edit screen appears.



10. Repeat steps 5 through 9 for more registrations.

10.9.2 CHANGING EXISTING GROUP NAMES

1. Press the "Group" field on the Program Menu Select screen.



2. The Group List screen appears.

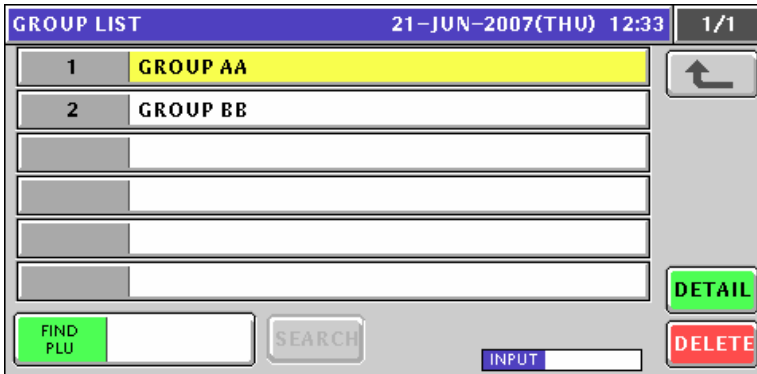

3. When changing an existing data, press to select a desired field.

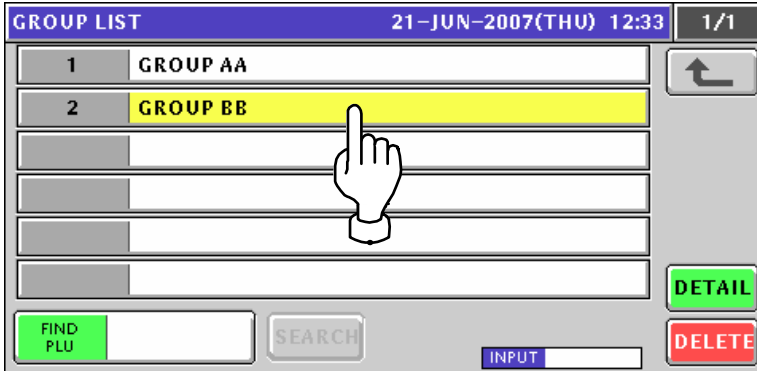

4. The Group Edit screen appears for the selected group



5. Edit a text according to the procedures described in Appendix “Text Editing”.

The screenshot shows the 'GROUP EDIT' screen with the title '21-JUN-2007(THU) 12:33'. The main display area contains the text 'GRP. BB'. Below the text is a keyboard layout with keys for Q, W, E, R, T, Y, U, I, O, P; A, S, D, F, G, H, J, K, L; and Z, X, C, V, B, N, M, comma, period. At the bottom, there is a control panel with fields for 'No.' (2), 'CHAR' (007), 'REMAIN' (1018), 'STYLE' (/), 'FONT' (30x15/30x15), and buttons for 'INPUT' and 'ERASE'.

6. Press the [ESC] key on the key sheet to escape from text editing mode.

ESC

The confirmation screen appears. Then, press the [SAVE] button.

The screenshot shows the 'PROGRAM CHECK' screen with the title '21-JUN-2007(THU) 12:33'. The main display area contains the text 'PROGRAM CHECK' and the question 'Are you sure you want to save changes? To confirm changes press SAVE to undo changes press CANCEL'. At the bottom, there is a control panel with a field for '19001 - 0000' and buttons for 'SAVE' and 'CANCEL'. A hand icon is pointing to the 'SAVE' button.

7. The edited text has been registered.

The screenshot shows the 'GROUP LIST' screen with the title '21-JUN-2007(THU) 12:33' and '1/1'. The main display area contains a list of groups: 1 GROUP AA, 2 GRP. BB, and several empty rows. The 'GRP. BB' row is highlighted in yellow. At the bottom, there is a control panel with buttons for 'DETAIL', 'FIND PLU', 'SEARCH', 'INPUT', and 'DELETE'.

8. Repeat steps 3 through 7 for more registrations.

10.10 COOKING INSTRUCTION REGISTRATION

10.10.1 CREATING NEW INSTRUCTIONS

1. Press the "Cooking Instruction" field on the Program Menu Select screen.



2. The Cooking Time List screen appears. Then, press the [NEW] button.

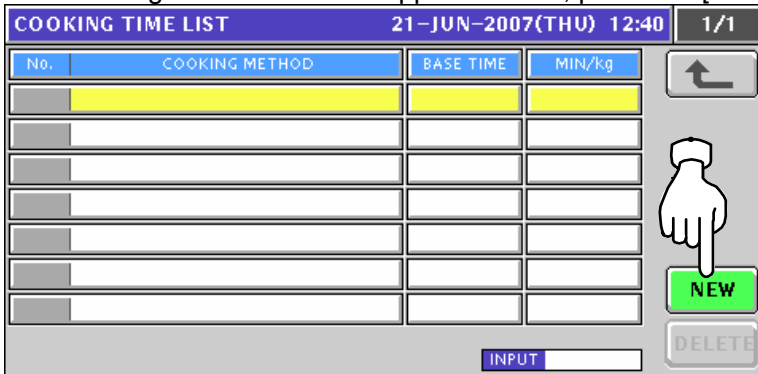

3. The confirmation screen appears. Then, press the [ENTER] button.

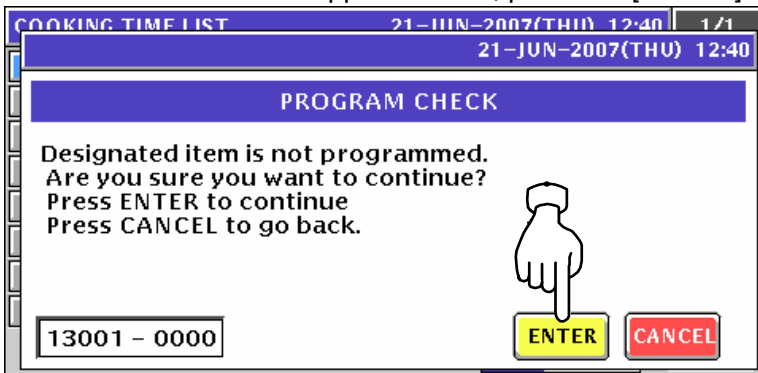

4. The Cooking Time Edit screen appears.

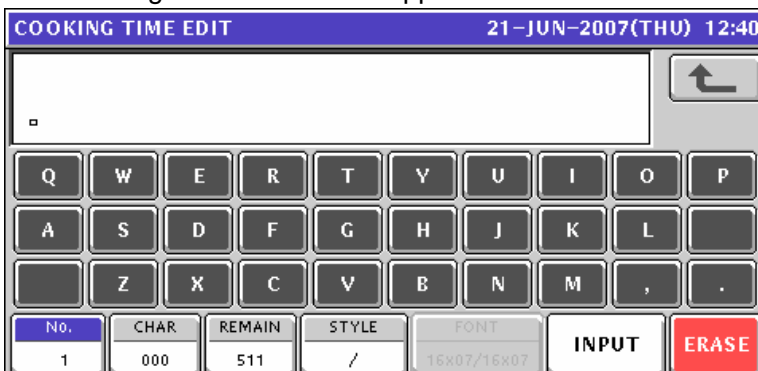

5. Edit a text according to the procedures described in Appendix “Text Editing”.

6. Press the [ESC] key on the key sheet to escape from text editing mode.

ESC

The confirmation screen appears. Then, press the [SAVE] button.

7. The edited text has been registered.

No.	COOKING METHOD	BASE TIME	MIN/kg
1	COOKING INSTRUCTION AA	0	0

8. Enter a numeric value for each filed using the numeric keys and press the corresponding field for registration.

EXAMPLE Base time “35 minutes”



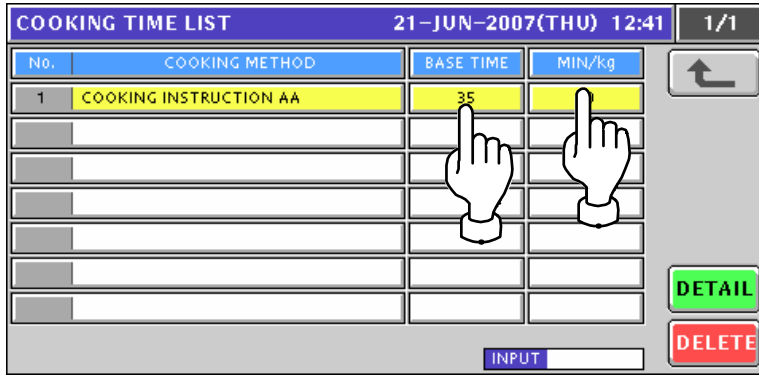

- When creating more instructions, enter a desired cooking instruction number using the numeric keys and press the [PLU] key on the key sheet.

EXAMPLE Cooking instruction number “2”.

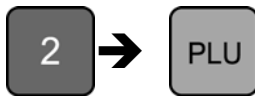

The confirmation screen appears. Then, press the [ENTER] button.

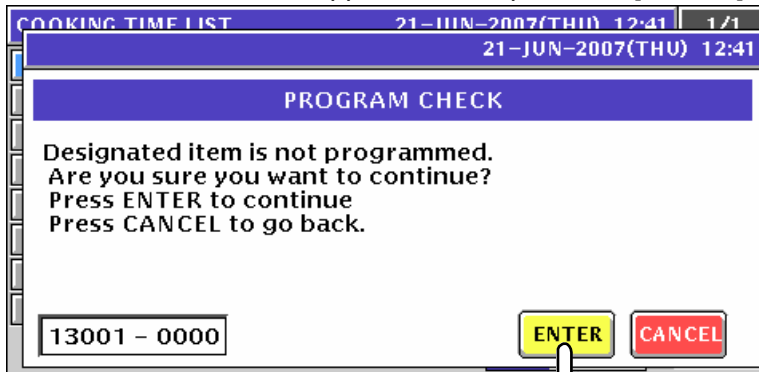

- The Cooking Time Edit screen appears.

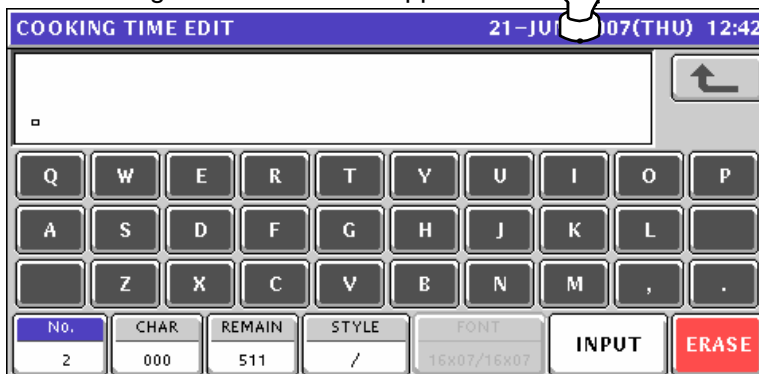

- Repeat steps 5 through 10 for more registrations.

10.10.2 CHANGING EXISTING INSTRUCTIONS

1. Press the "Cooking Instruction" field on the Program Menu Select screen.



2. The Cooking Time List screen appears.

The screenshot shows the 'COOKING TIME LIST' screen with a header bar displaying '21-JUN-2007(THU) 12:45' and '1/1'. The table below has the following data:

No.	COOKING METHOD	BASE TIME	MIN/kg
1	COOKING INSTRUCTION AA	35	20
2	COOKING INSTRUCTION BB	20	25

On the right side, there are up and down arrow buttons, a 'DETAIL' button, and a 'DELETE' button. At the bottom, there is an 'INPUT' field.

3. When changing an existing data, press to select a desired field and press the [DETAIL] button.

The screenshot shows the 'COOKING TIME LIST' screen with the same table as in step 2. The row for 'COOKING INSTRUCTION BB' is highlighted in yellow. A hand cursor is pointing at the 'COOKING METHOD' column of this row. Another hand cursor is pointing at the 'DETAIL' button on the right. The 'DELETE' button is also visible below it.

4. The Cooking Time Edit screen appears for the selected instruction

The screenshot shows the 'COOKING TIME EDIT' screen with a header bar displaying '21-JUN-2007(THU) 12:45'. The main area shows the text 'COOKING INSTRUCTION BB' in a large font. Below the text is a keyboard with letters Q through P, A through L, and Z through M. At the bottom, there are several fields: 'No.' (2), 'CHAR' (022), 'REMAIN' (489), 'STYLE' (/), 'FONT' (16x07/16x07), 'INPUT', and 'ERASE'.

5. Edit a text according to the procedures described in Appendix “Text Editing”.



6. Press the [ESC] key on the key sheet to escape from text editing mode.



The confirmation screen appears. Then, press the [SAVE] button.

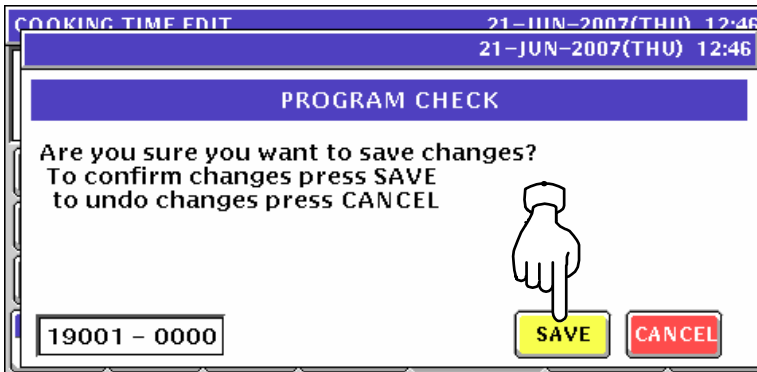

7. The edited text has been registered.

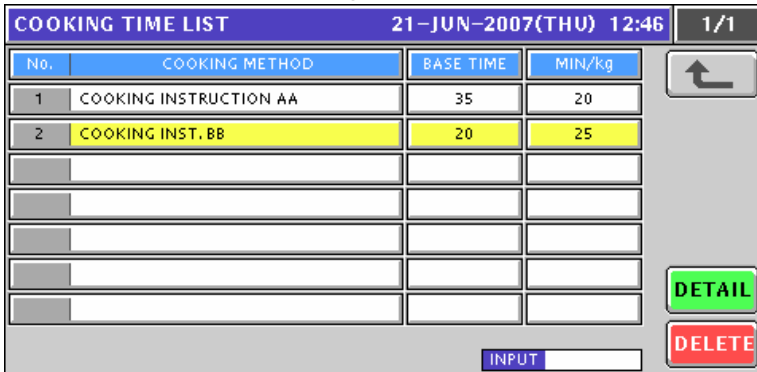

8. Repeat steps 3 through 7 for more registrations.

10.11 NUTRITION FILE REGISTRATION

10.11.1 CREATING NEW NUTRITION DATA

1. Press the "Nutrition (USA)" field on the Program Menu Select screen.

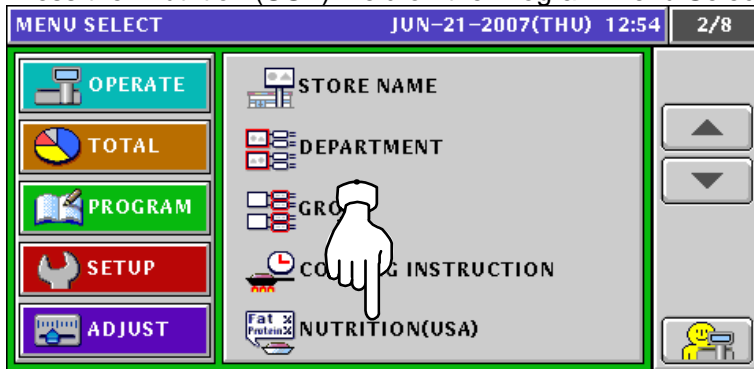

2. The Nutrition List screen appears. Then, press the [NEW] button.

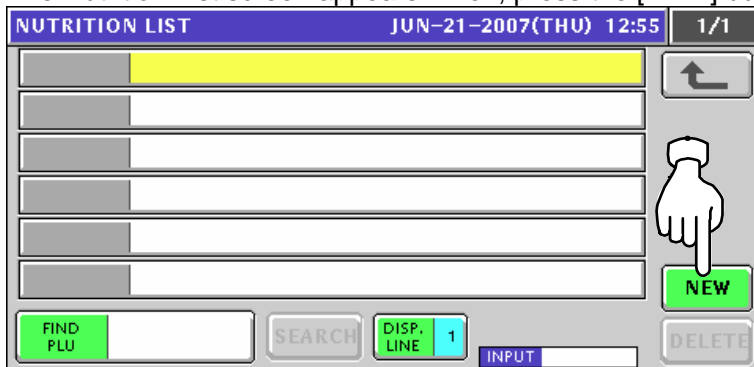

3. The confirmation screen appears. Then, press the [ENTER] button.

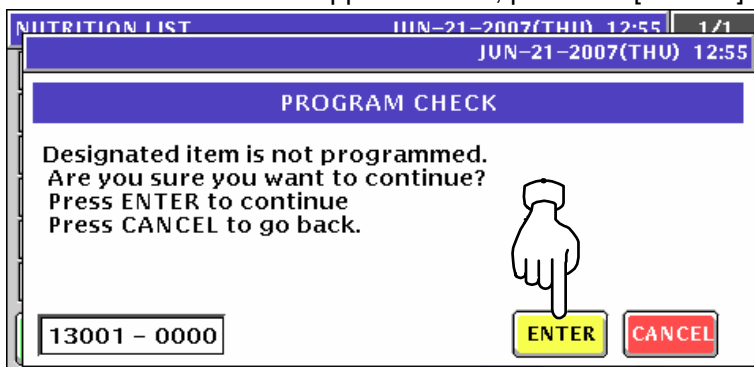

4. The Nutrition Data Programming screen for the selected nutrition number appears. When creating a text for "Serving Size", press the [EDIT] button.

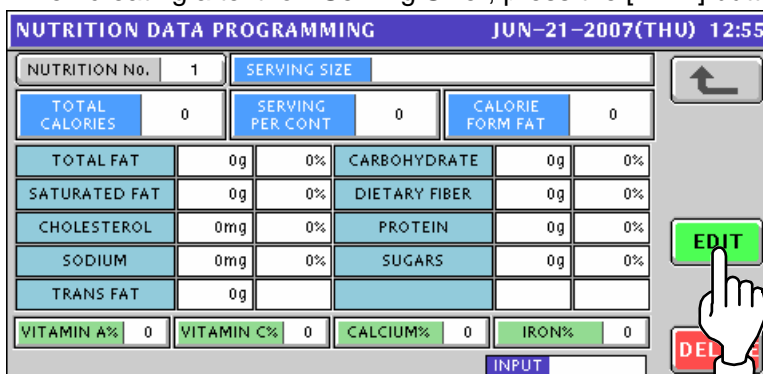

5. The Nutrition Edit screen appears.

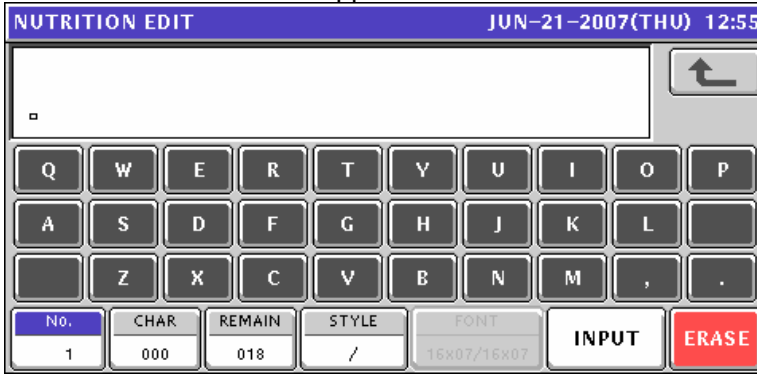

6. Edit a text according to the procedures described in Appendix “Text Editing”.



7. Press the [ESC] key on the key sheet to escape from text editing mode.



The confirmation screen appears. Then, press the [SAVE] button.

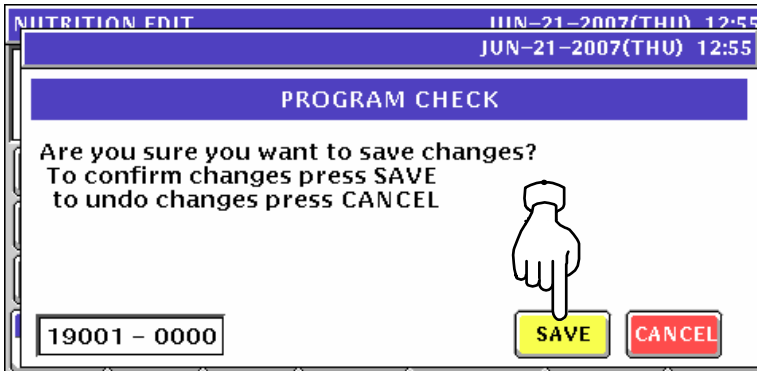

8. The edited text has been registered. Then, enter a nutrition data for each field using the numeric keys and press the corresponding field for registration.

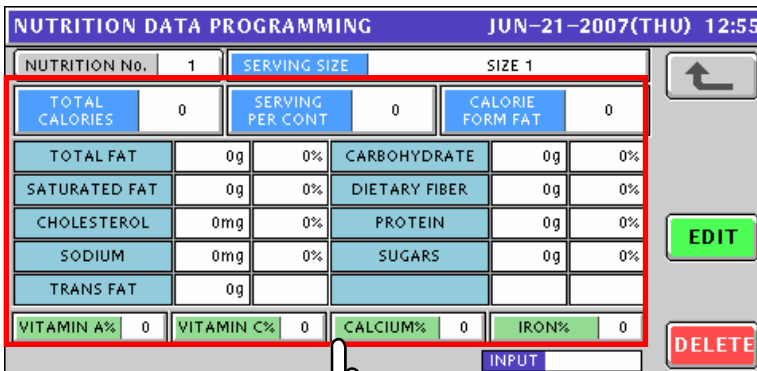

9. When creating more nutrition data, enter a desired nutrition number using the numeric keys and press the [PLU] key on the key sheet.

EXAMPLE Nutrition number "2".

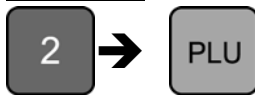

The confirmation screen appears. Then, press the [ENTER] button.

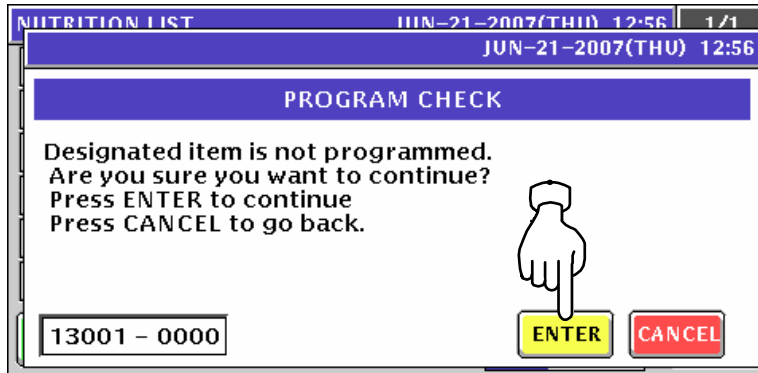

10. Repeat steps 4 through 9 for more registrations.

10.11.2 CHANGING EXISTING NUTRITION DATA

1. Press the "Nutrition (USA)" field on the Program Menu Select screen.



2. The Nutrition List screen appears.

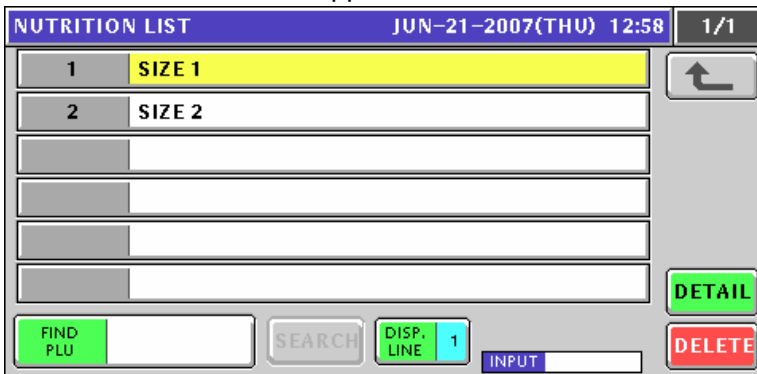

3. Select a desired nutrition number.

EXAMPLE Nutrition number "2".

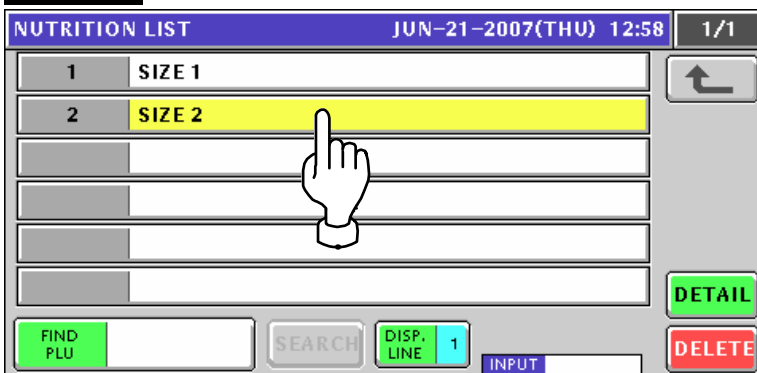

or press the [PLU] key on the key sheet after a numeric entry.

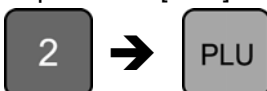

4. Press the [DETAIL] button,

NUTRITION LIST		JUN-21-2007(THU) 12:58		1/1
1	SIZE 1			
2	SIZE 2			
<input type="button" value="FIND PLU"/> <input type="button" value="SEARCH"/> <input type="button" value="DISP. LINE 1"/> <input type="text" value="INPUT"/> <input type="button" value="DELETE"/>				

5. The Nutrition Data Programming screen for the selected nutrition number appears. When changing a text for "Serving Size", press the [EDIT] button.

NUTRITION DATA PROGRAMMING				JUN-21-2007(THU) 12:58	
NUTRITION No.	2	SERVING SIZE	SIZE 2		
TOTAL CALORIES	0	SERVING PER CONT	0	CALORIE FORM FAT	0
TOTAL FAT	0g	0%	CARBOHYDRATE	0g	10%
SATURATED FAT	0g	0%	DIETARY FIBER	10g	0%
CHOLESTEROL	0mg	0%	PROTEIN	0g	0%
SODIUM	0mg	0%	SUGARS	0g	0%
TRANS FAT	0g				
VITAMIN A%	0	VITAMIN C%	20	CALCIUM%	0
				IRON%	0
<input type="button" value="EDIT"/>				<input type="button" value="DELETE"/>	
<input type="text" value="INPUT"/>					

6. The Nutrition Edit screen appears.

NUTRITION EDIT		JUN-21-2007(THU) 12:58							
<input type="text" value="SIZE 2"/>		<input type="button" value="↶"/>							
Q	W	E	R	T	Y	U	I	O	P
A	S	D	F	G	H	J	K	L	
	Z	X	C	V	B	N	M	,	.
No.	CHAR	REMAIN	STYLE	FONT	INPUT		ERASE		
2	006	012	/	16x07/16x07					

7. Edit a text according to the procedures described in Appendix "Text Editing".

NUTRITION EDIT		JUN-21-2007(THU) 12:58							
<input type="text" value="SIZE BB"/>		<input type="button" value="↶"/>							
Q	W	E	R	T	Y	U	I	O	P
A	S	D	F	G	H	J	K	L	
	Z	X	C	V	B	N	M	,	.
No.	CHAR	REMAIN	STYLE	FONT	INPUT		ERASE		
2	007	011	/	16x07/16x07					

8. Press the [ESC] key on the key sheet to escape from text editing mode.

ESC

The confirmation screen appears. Then, press the [SAVE] button.

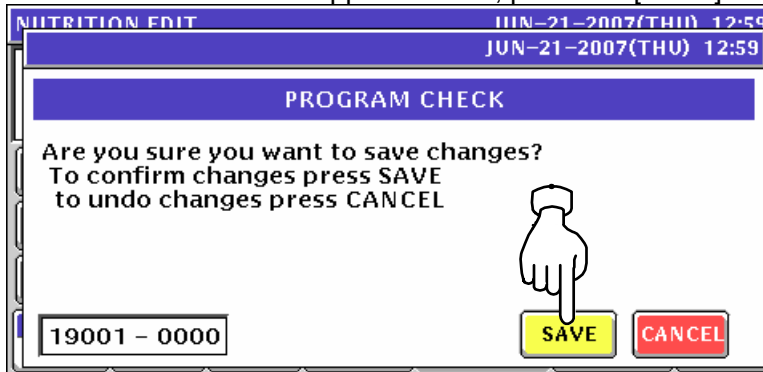

9. The edited text has been registered. When necessary, enter a nutrition data for each field using the numeric keys and press the corresponding field for registration.

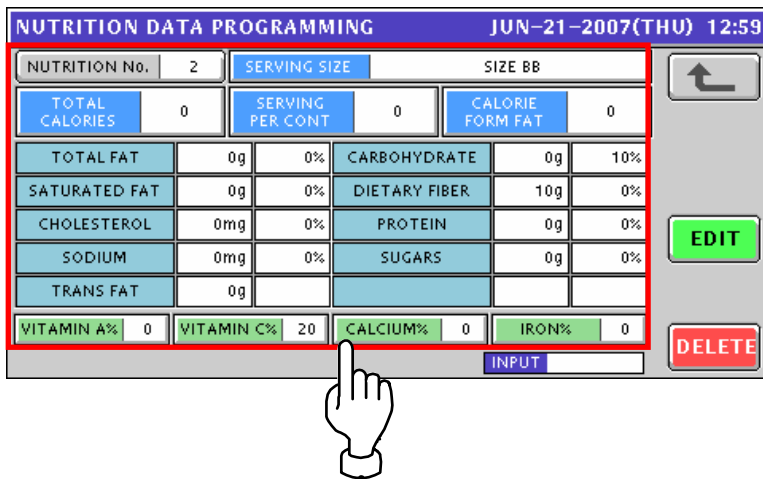

10. Press the Return button after making necessary changes.

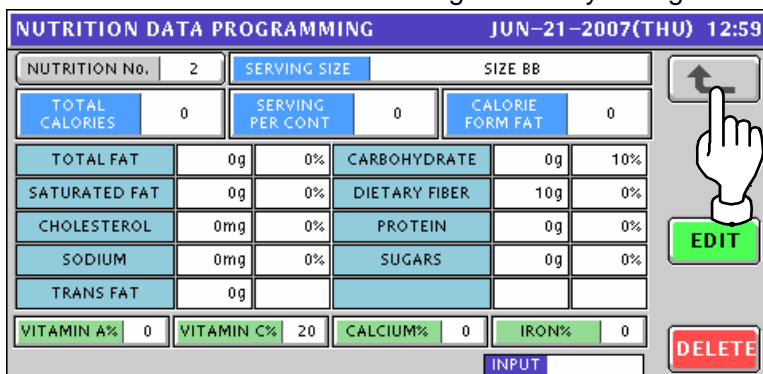

11. Repeat steps 3 through 10 for more registrations.

10.12 EXTRA MESSAGE REGISTRATION

10.12.1 CREATING NEW MESSAGES

1. Press the "Extra Message" field on the Program Menu Select screen.

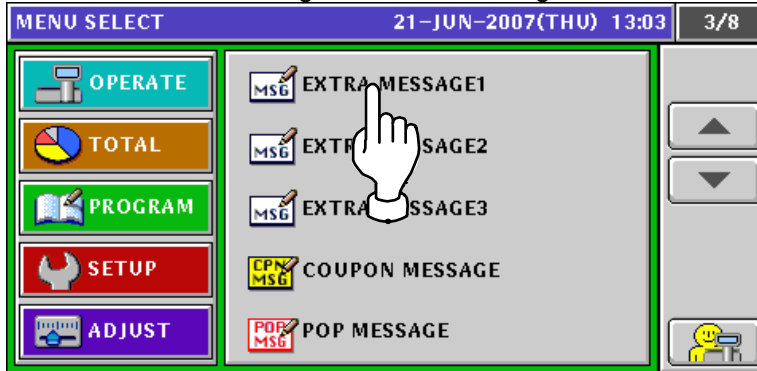

2. The Extra Message List screen appears. Then, press the [NEW] button.

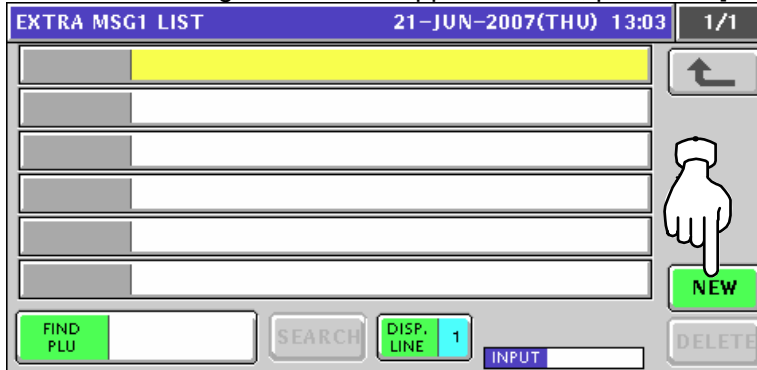

3. The confirmation screen appears. Then, press the [ENTER] button.

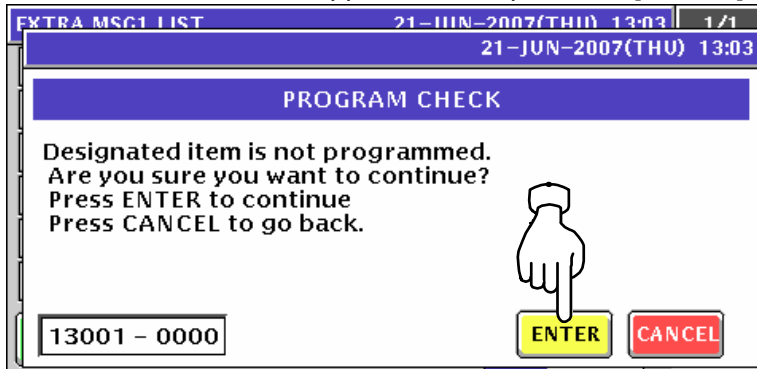

4. The Extra Message Edit screen appears.

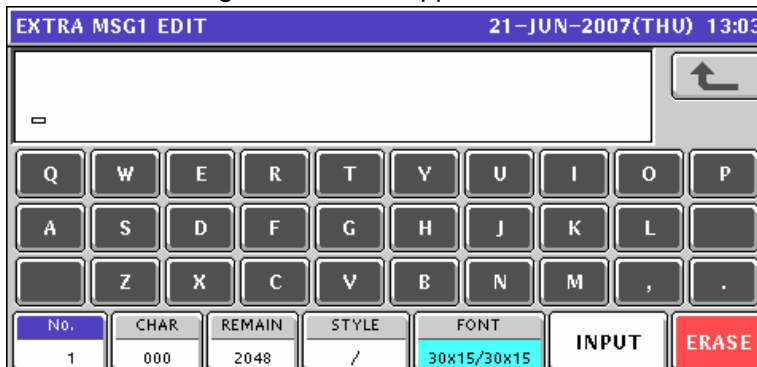

5. Edit a text according to the procedures described in Appendix “Text Editing”.



6. Press the [ESC] key on the key sheet to escape from text editing mode.



The confirmation screen appears. Then, press the [SAVE] button.

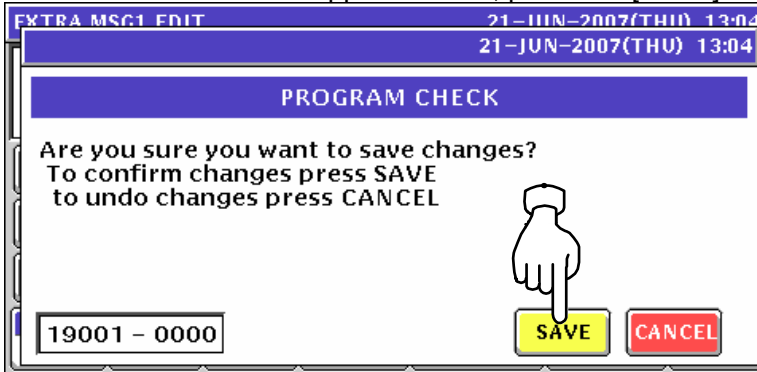

7. The edited text has been registered.

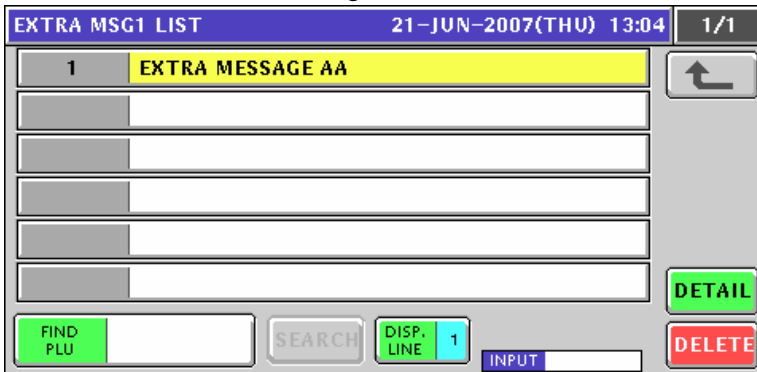

8. When creating more messages, enter a desired message number using the numeric keys and press the [PLU] key on the key sheet.

EXAMPLE Message number “2”.

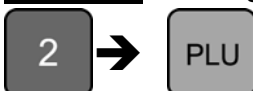

The confirmation screen appears. Then, press the [ENTER] button.

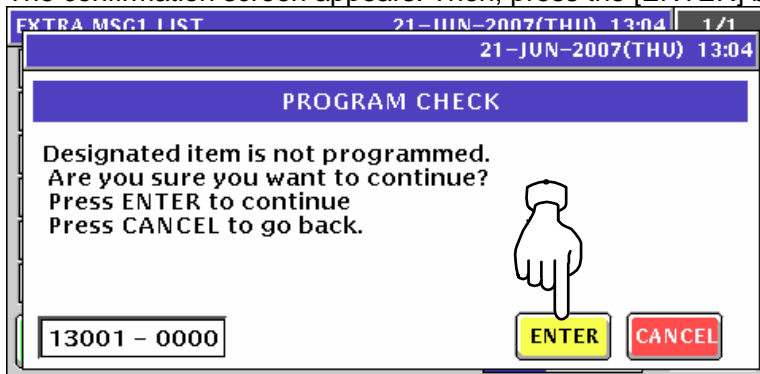

9. Repeat steps 4 through 8 for more registrations.

10.12.2 CHANGING EXISITING MESSAGES

1. Press the "Extra Message" field on the Program Menu Select screen.



2. The Extra Message List screen appears.



3. Select a desired message number.

EXAMPLE Message number "2".

Press a desired field,

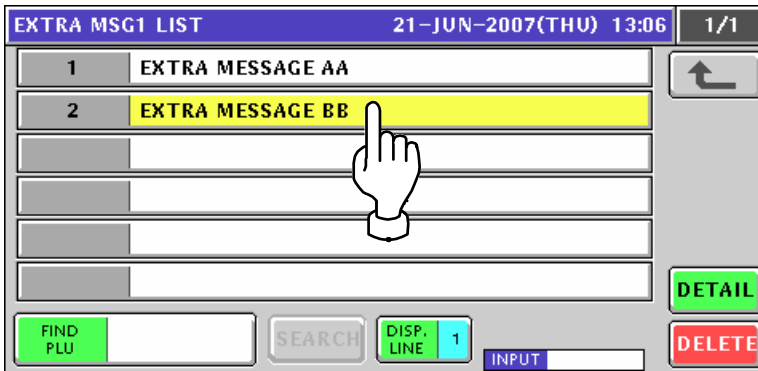

or press the [PLU] key on the key sheet after a numeric entry.



4. Press the [DETAIL] button.

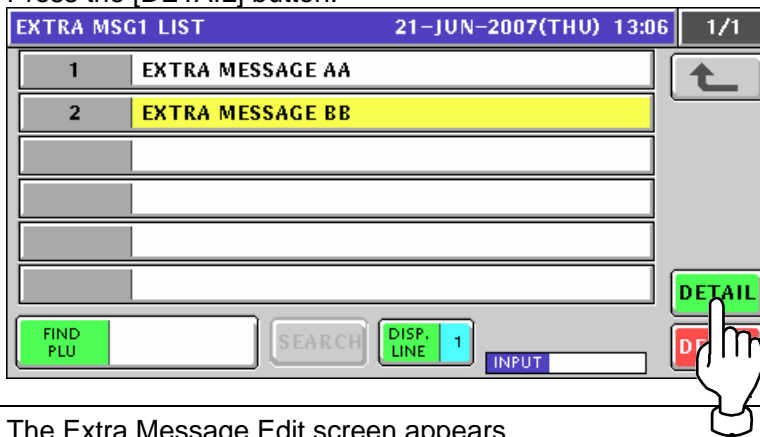

5. The Extra Message Edit screen appears.



6. Edit a text according to the procedures described in Appendix "Text Editing".



7. Press the [ESC] key on the key sheet to escape from text editing mode.

ESC

The confirmation screen appears. Then, press the [SAVE] button.

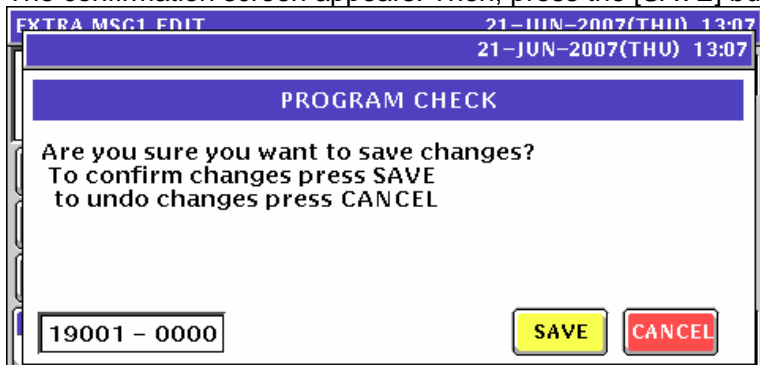

8. Repeat steps 3 through 7 for more registrations.

10.13 COUPON MESSAGE REGISTRATION

10.13.1 CREATING NEW MESSAGES

1. Press the "Coupon Message" field on the Program Menu Select screen.

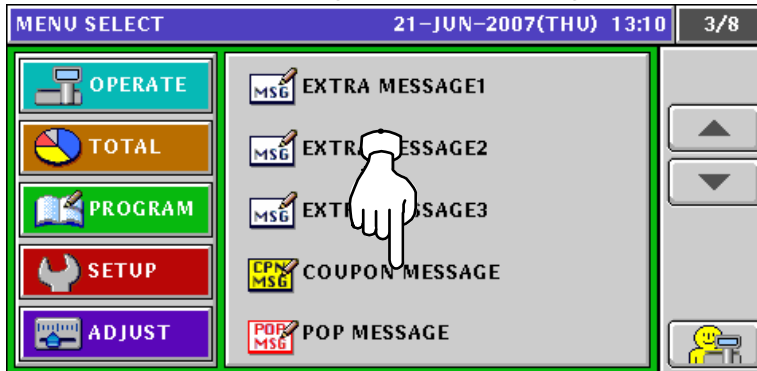

2. The Coupon Message List screen appears. Then, press the [NEW] button.

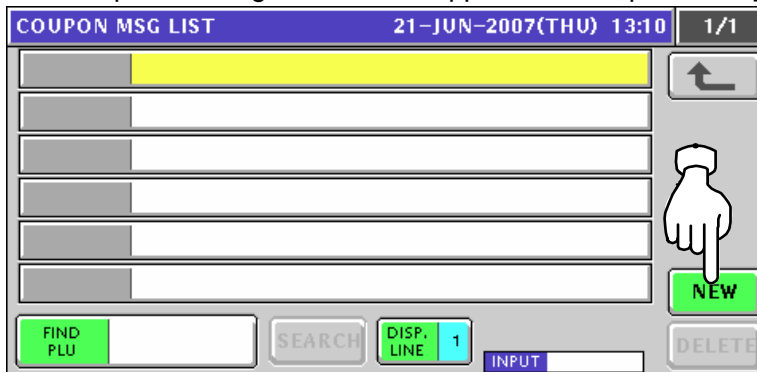

3. The confirmation screen appears. Then, press the [ENTER] button.

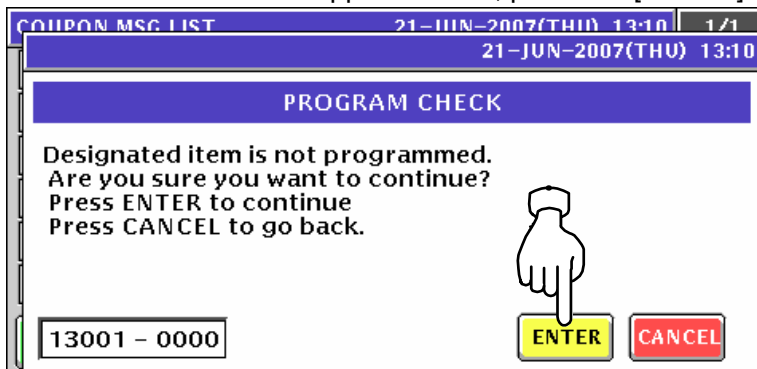

4. The Coupon Message Edit screen appears.

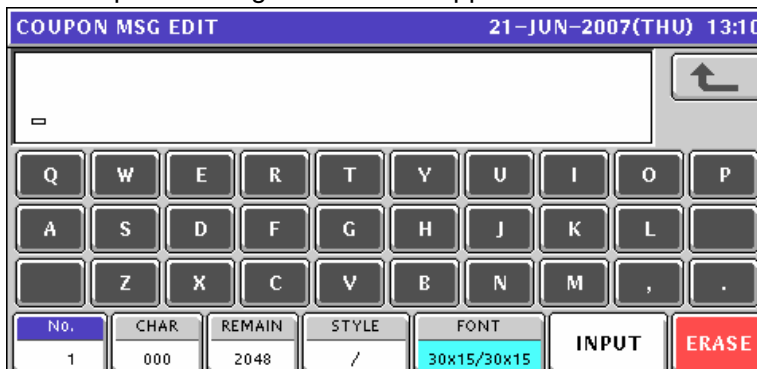

5. Edit a text according to the procedures described in Appendix “Text Editing”.

6. Press the [ESC] key on the key sheet to escape from text editing mode.

ESC

The confirmation screen appears. Then, press the [SAVE] button.

7. The edited text has been registered.

8. When creating more messages, enter a desired message number using the numeric keys and press the [PLU] key on the key sheet.

EXAMPLE Message number “2”.

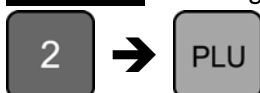

The confirmation screen appears. Then, press the [ENTER] button.

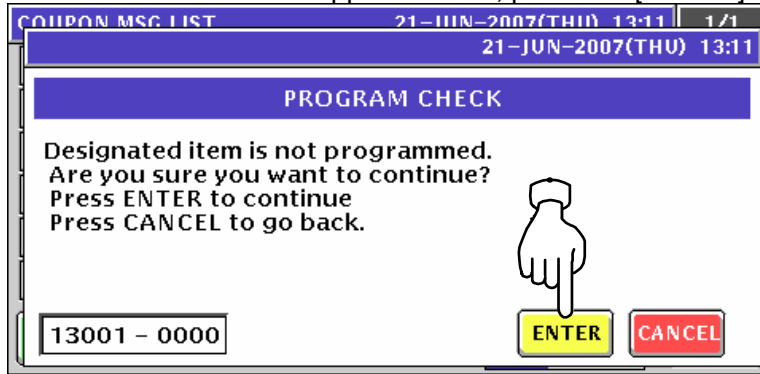

-
- 9.** Repeat steps 4 through 8 for more registrations.
-

10.13.2 CHANGING EXISTING MESSAGES

1. Press the "Extra Message" field on the Program Menu Select screen.

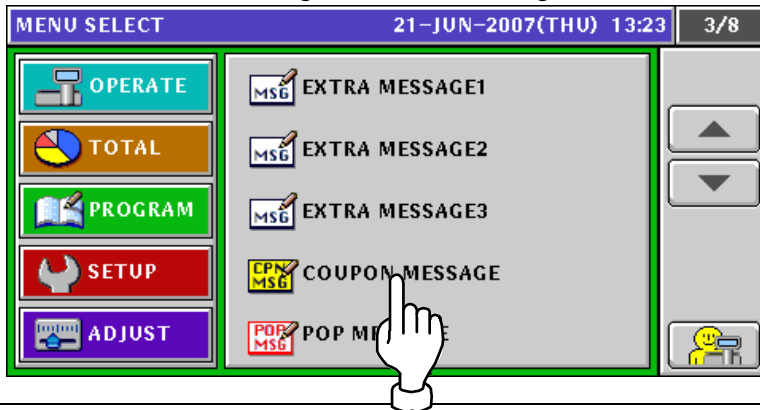

2. The Coupon Message List screen appears.

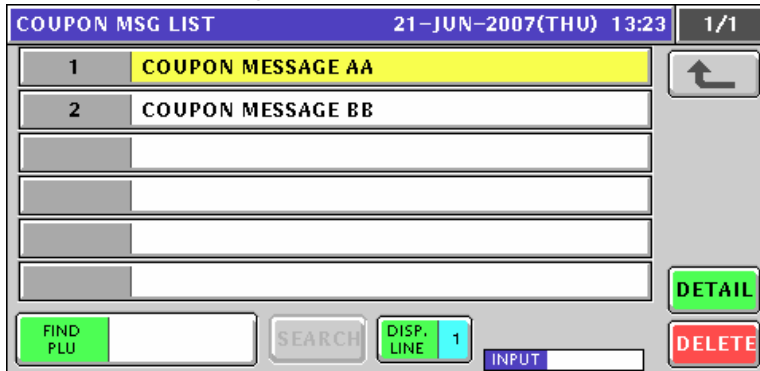

3. Select a desired message number.

EXAMPLE Message number "2".

Press a desired field,

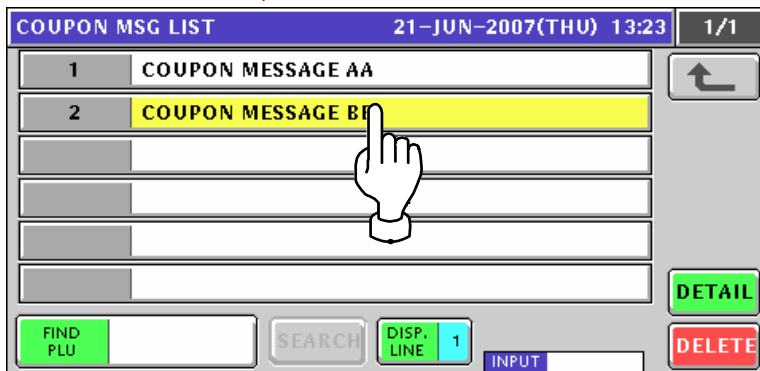

or press the [PLU] key on the key sheet after a numeric entry.



4. Press the [DETAIL] button.

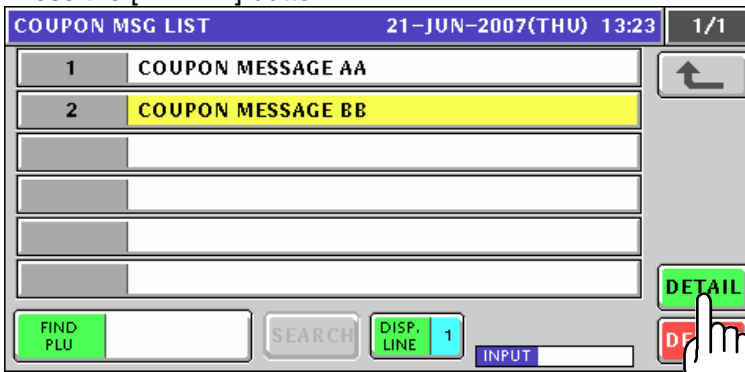

5. The Coupon Message Edit screen appears.



6. Edit a text according to the procedures described in Appendix “Text Editing”.



7. Press the [ESC] key on the key sheet to escape from text editing mode.



The confirmation screen appears. Then, press the [SAVE] button.

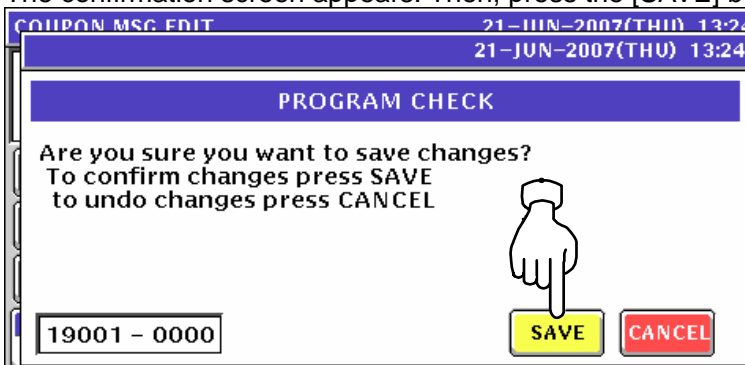

8. Repeat steps 3 through 7 for more registrations.

10.14 POP MESSAGE REGISTRATION

1. Press the "POP Message" field on the Program Menu Select screen.



2. The message list screen appears.



3. Enter a desired message number and press the [PLU] key on the key sheet.

EXAMPLE Message number "7".



The confirmation screen appears. Then, press the [ENTER] button.

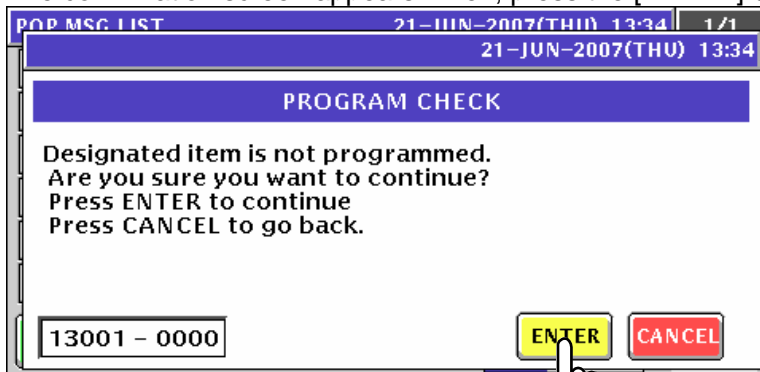

4. The POP Message Edit screen appears.



Edit a text according to the procedures described in Appendix "Text Editing".



5. P Press the [ESC] key on the key sheet to escape from text editing mode.



The confirmation screen appears. Then, press the [SAVE] button.

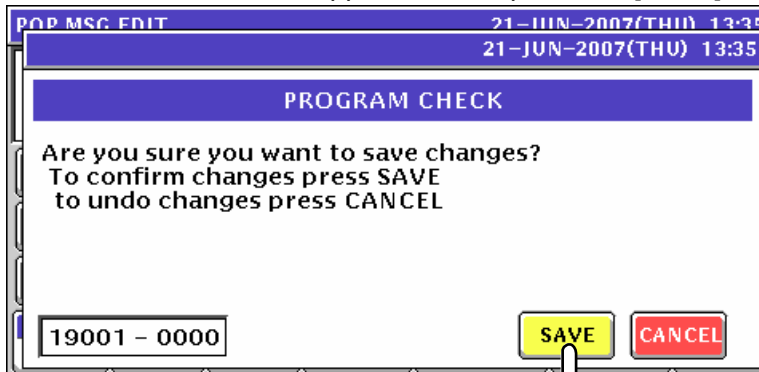

6. The edited text has been registered.

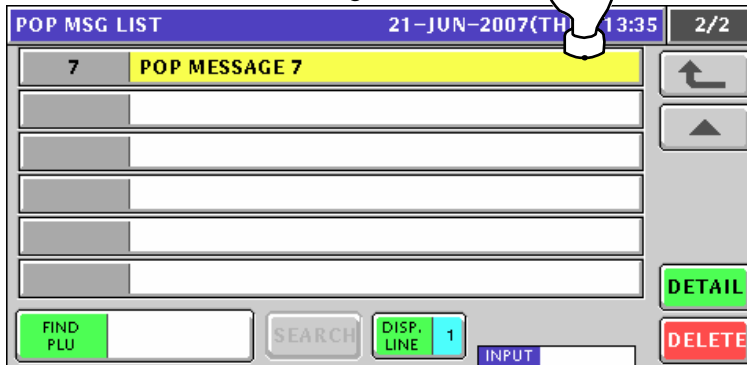

7. Repeat steps 3 through 6 for more registrations.

10.15 TAX REGISTRATION

1. Press the "Tax" field on the Program Menu Select screen.

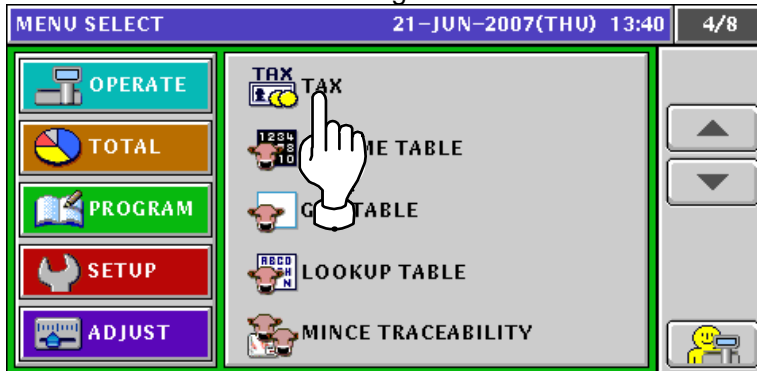

2. The Tax List screen appears.

TAX No.	TAX TYPE	TAX RATE
0	EXCLUSIVE	5.00 %
1	EXCLUSIVE	5.00 %
2	EXCLUSIVE	5.00 %
3	EXCLUSIVE	5.00 %
4	EXCLUSIVE	5.00 %

3. When changing a tax system, press to select a desired field.

TAX No.	TAX TYPE	TAX RATE
0	EXCLUSIVE	5.00 %
1	EXCLUSIVE	5.00 %
2	EXCLUSIVE	5.00 %
3	EXCLUSIVE	5.00 %
4	EXCLUSIVE	5.00 %

ITEM	DESCRIPTION
TAX TYPE	Press to select one of tax types. Exclusive tax Inclusive tax Tax exemption
TAX RATE	Enter a numeric value and press this field.

10.16 SCHEME TABLE REGISTRATION

10.16.1 CREATING NEW TABLES

1. Press the "Scheme Table" field on the Program Menu Select screen.

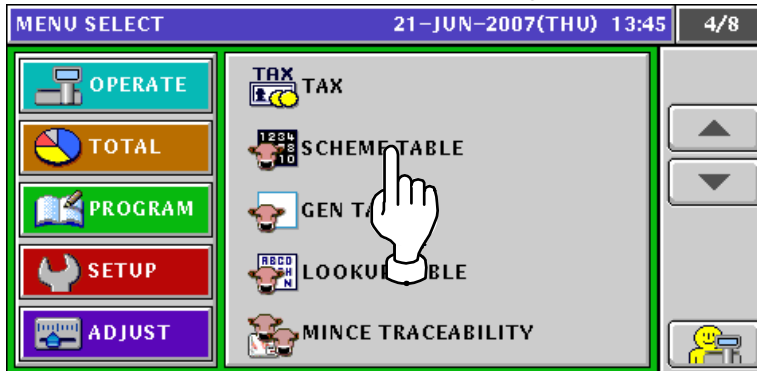

2. The Scheme Table screen appears. Then, press the [NEW] button.



3. The confirmation screen appears. Then, press the [ENTER] button.

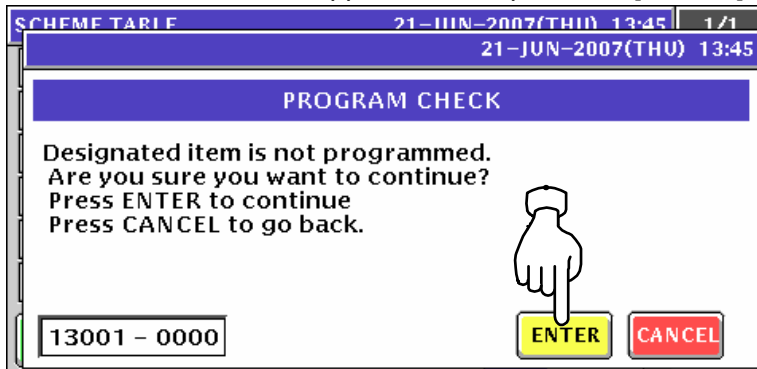

4. The Scheme Table Detail (Basic) screen appears. Then, press the [EDIT] button.

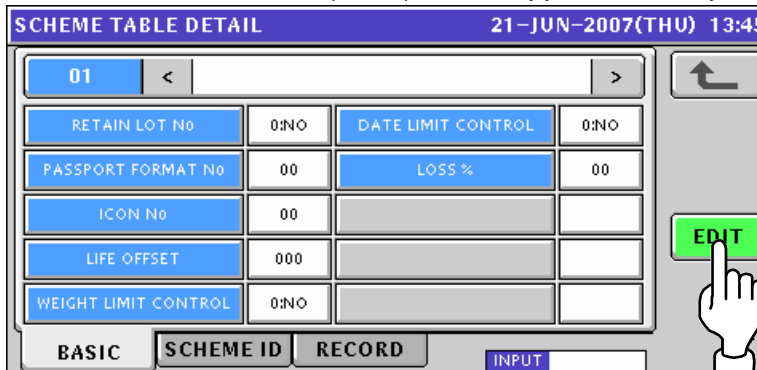

5. The Scheme Table Edit screen appears.

6. Edit a text according to the procedures described in Appendix "Text Editing".

7. Press the [ESC] key on the key sheet to escape from text editing mode.

ESC

The confirmation screen appears. Then, press the [SAVE] button.

8. The edited text has been registered.

SCHEME TABLE 1			
RETAIN LOT No	0:NO	DATE LIMIT CONTROL	0:NO
PASSPORT FORMAT No	00	LOSS %	00
ICON No	00		
LIFE OFFSET	000		
WEIGHT LIMIT CONTROL	0:NO		

ITEM	DESCRIPTION
RETAIN LOT No.	Press to select whether or not to use this lot number. 0: No 1: Yes
PASSPORT FORMAT No.	Enter a numeric value and press this field.
ICON No.	Enter a numeric value and press this field.
LIFE OFFSET	Enter a numeric value and press this field.
WEIGHT LIMIT CONTROL	Press to select whether or not to control the weight limit. 0: No 1: Yes
DATE LIMIT CONTROL	Press to select whether or not to control the date limit. 0: No 1: Yes
LOSS %	Enter a numeric value and press this field

SCHEME TABLE DETAIL 21-JUN-2007(THU) 13:46

01 < SCHEME TABLE 1 >

	AI	START	STOP	MAX DIGIT
LOT/CARCASS		00	00	00
GTIN		00	00	00
WEIGHT		00	00	00
PASSPORT LOT START		0		
PASSPORT GTIN START		0		

BASIC SCHEME ID RECORD INPUT

EDIT

ITEM	DESCRIPTION
LOT/CARCASS	Enter a numeric value and press the corresponding field.
GTIN	Enter a numeric value and press the corresponding field.
WEIGHT	Enter a numeric value and press the corresponding field.
PASSPORT LOT START	Enter a numeric value and press this field.
PASSPORT GTIN START	Enter a numeric value and press this field.

SCHEME TABLE DETAIL 21-JUN-2007(THU) 13:46 1/4

01 < SCHEME TABLE 1 >

TITLE TEXT	START	STOP	AI	VARIABLE
	00	00		0:NO
	00	00		0:NO
	00	00		0:NO
	00	00		0:NO

BASIC SCHEME ID RECORD INPUT

DELETE

EDIT

9. When creating more tables, enter a desired table number using the numeric keys and press the [PLU] key on the key sheet.

EXAMPLE Table number "2".

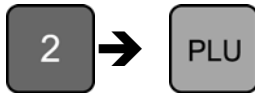

The confirmation screen appears. Then, press the [ENTER] button.

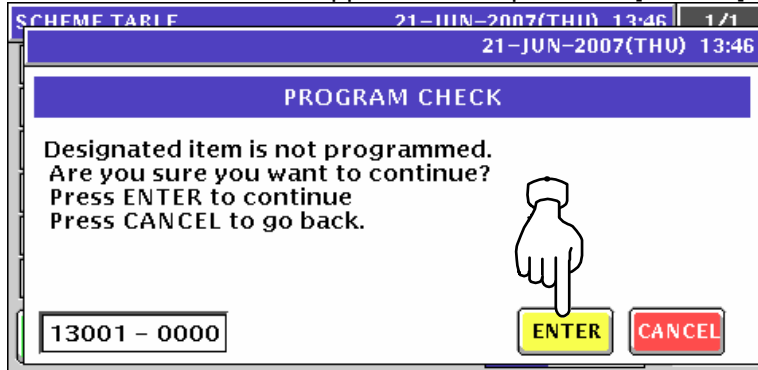

10. Repeat steps 4 through 9 for more registrations.

10.16.2 CHANGING EXISITING MESSAGES

1. Press the "Scheme Table" field on the Program Menu Select screen.

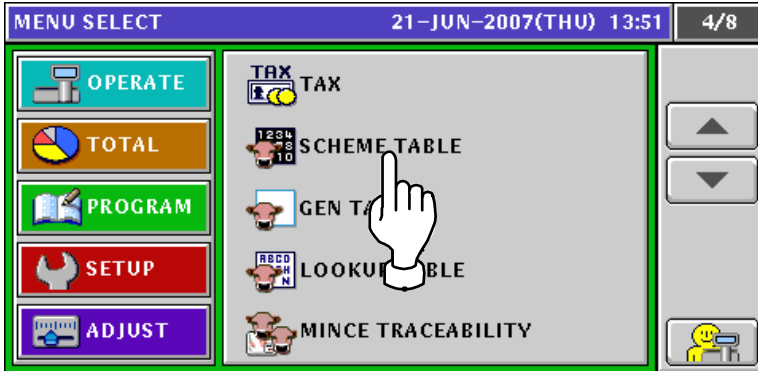

2. The Scheme Table screen appears.

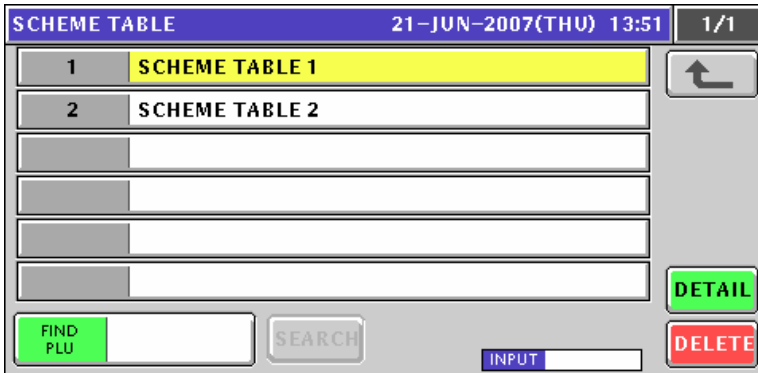

3. Select a desired table number by pressing the corresponding field.

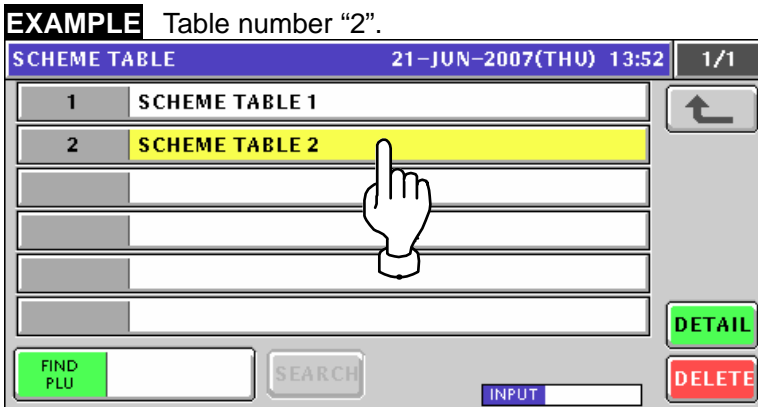

or press the [PLU] key on the key sheet after a numeric entry.



4. Press the [DETAIL] button.

5. The Scheme Table Detail (Basic) screen appears.

ITEM	DESCRIPTION
RETAIN LOT No.	Press to select whether or not to use this lot number. 0: No 1: Yes
PASSPORT FORMAT No.	Enter a numeric value and press this field.
ICON No.	Enter a numeric value and press this field.
LIFE OFFSET	Enter a numeric value and press this field.
WEIGHT LIMIT CONTROL	Press to select whether or not to control the weight limit. 0: No 1: Yes
DATE LIMIT CONTROL	Press to select whether or not to control the date limit. 0: No 1: Yes
LOSS %	Enter a numeric value and press this field

SCHEME TABLE DETAIL 21-JUN-2007(THU) 13:52

02 < SCHEME TABLE 2 >

	AI	START	STOP	MAX DIGIT
LOT/CARCASS		00	00	00
GTIN		00	00	00
WEIGHT		00	00	00
PASSPORT LOT START		0		
PASSPORT GTIN START		0		

BASIC SCHEME ID RECORD INPUT

EDIT

ITEM	DESCRIPTION
LOT/CARCASS	Enter a numeric value and press the corresponding field.
GTIN	Enter a numeric value and press the corresponding field.
WEIGHT	Enter a numeric value and press the corresponding field.
PASSPORT LOT START	Enter a numeric value and press this field.
PASSPORT GTIN START	Enter a numeric value and press this field.

SCHEME TABLE DETAIL 21-JUN-2007(THU) 13:52 1/4

02 < SCHEME TABLE 2 >

TITLE TEXT	START	STOP	AI	VARIABLE
	00	00		0:NO
	00	00		0:NO
	00	00		0:NO
	00	00		0:NO

BASIC SCHEME ID RECORD INPUT DELETE

EDIT

6. When changing the table name, press the [EDIT] button.

SCHEME TABLE DETAIL 21-JUN-2007(THU) 13:52

02 < SCHEME TABLE 2 >

RETAIN LOT No	0:NO	DATE LIMIT CONTROL	0:NO
PASSPORT FORMAT No	00	LOSS %	00
ICON No	00		
LIFE OFFSET	000		
WEIGHT LIMIT CONTROL	0:NO		

BASIC SCHEME ID RECORD INPUT

EDIT



7. The Scheme Table Edit screen appears.

SCHEME TABLE EDIT 21-JUN-2007(THU) 13:52

SCHEME TABLE 2

Q	W	E	R	T	Y	U	I	O	P
A	S	D	F	G	H	J	K	L	
	Z	X	C	V	B	N	M	,	.
No.	CHAR	REMAIN							
2	014	018							

INPUT ERASE

8. Edit a text according to the procedures described in Appendix “Text Editing”.

9. Press the [ESC] key on the key sheet to escape from text editing mode.

ESC

The confirmation screen appears. Then, press the [SAVE] button.

10. The edited text has been registered. Then, press the Return button.

11. The Scheme Table screen appears.

12. Repeat steps 3 through 11 for more registrations.

10.17 GEN TABLE REGISTRATION

1. Press the "GEN Table" field on the Program Menu Select screen.

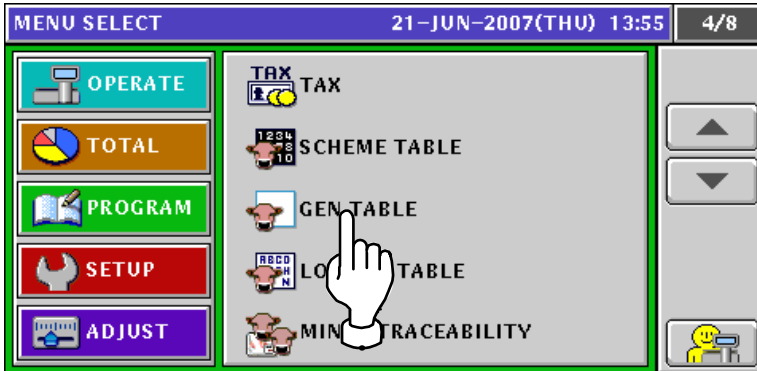

2. The GEN Table screen appears.

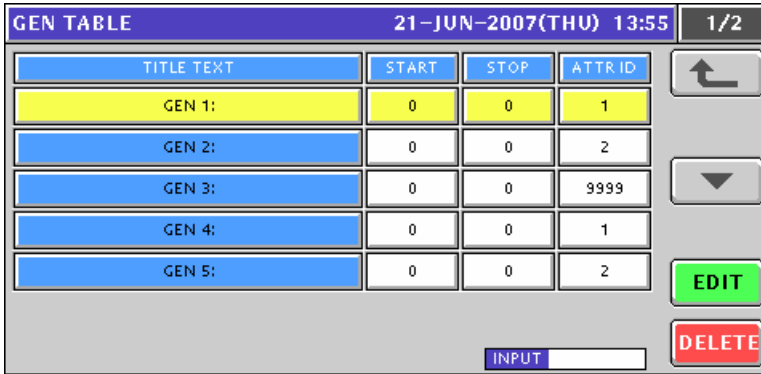

3. Select a desired GEN table by pressing the corresponding field.

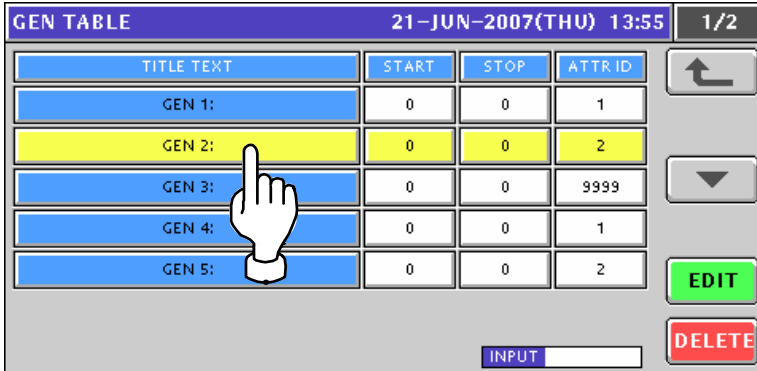

4. Enter a numeric value and press the corresponding field.

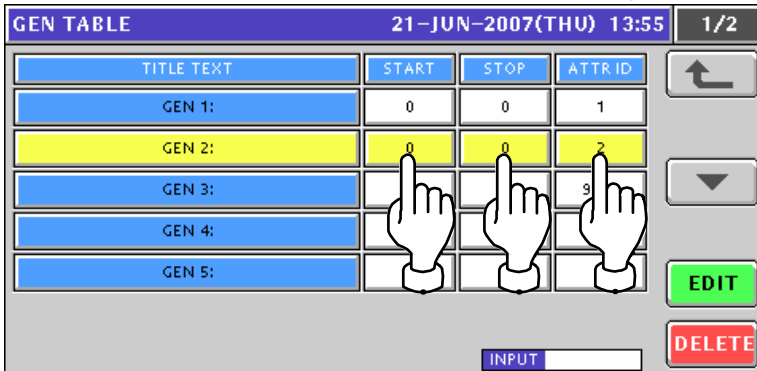

5. When changing the title text, press the [EDIT] button.

GEN TABLE				21-JUN-2007(THU) 13:55	1/2
TITLE TEXT	START	STOP	ATTR ID		
GEN 1:	0	0	1		
GEN 2:	0	0	2		
GEN 3:	0	0	9999		
GEN 4:	0	0	1		
GEN 5:	0	0	2		

INPUT [EDIT] [D]

6. The GEN Table Edit screen appears.

GEN TABLE EDIT			21-JUN-2007(THU) 13:56						
GEN 2:									
Q	W	E	R	T	Y	U	I	O	P
A	S	D	F	G	H	J	K	L	
	Z	X	C	V	B	N	M	,	.
No.	CHAR	REMAIN	INPUT		ERASE				
2	006	026							

7. Edit a text according to the procedures described in Appendix "Text Editing".

GEN TABLE EDIT			21-JUN-2007(THU) 13:56						
GEN TABLE 2:									
Q	W	E	R	T	Y	U	I	O	P
A	S	D	F	G	H	J	K	L	
	Z	X	C	V	B	N	M	,	.
No.	CHAR	REMAIN	INPUT		ERASE				
2	012	020							

8. Press the [ESC] key on the key sheet to escape from text editing mode.

ESC

The confirmation screen appears. Then, press the [SAVE] button.

PROGRAM CHECK	
Are you sure you want to save changes? To confirm changes press SAVE to undo changes press CANCEL	
19001 - 0000	[SAVE] [CANCEL]

9. The edited text has been registered.

GEN TABLE				21-JUN-2007(THU) 13:56	1/2
TITLE TEXT	START	STOP	ATTR ID		
GEN 1:	0	0	1	↑	
GEN TABLE 2:	0	0	2	↓	
GEN 3:	0	0	9999	EDIT	
GEN 4:	0	0	1	DELETE	
GEN 5:	0	0	2	INPUT	

10. Repeat steps 3 through 9 for more registrations.

10.18 LOOKUP TABLE REGISTRATION

10.18.1 CREATING NEW TABLES

1. Press the "Lookup Table" field on the Program Menu Select screen.

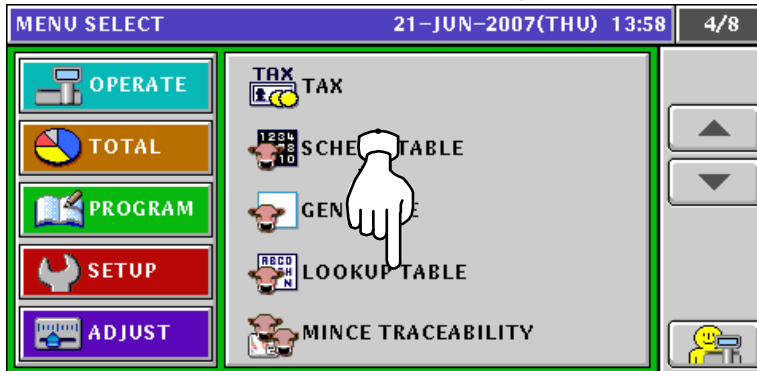

2. The Lookup Table screen appears. Then, press the [NEW] button.



3. The confirmation screen appears. Then, press the [ENTER] button.

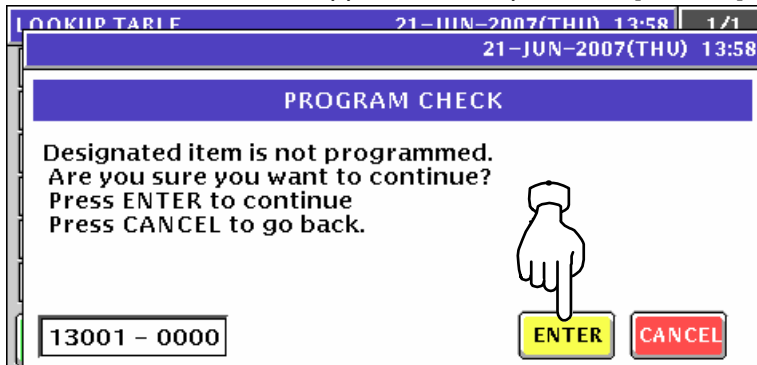

4. The Lookup Table Data List screen appears. Then, press the [EDIT] button.

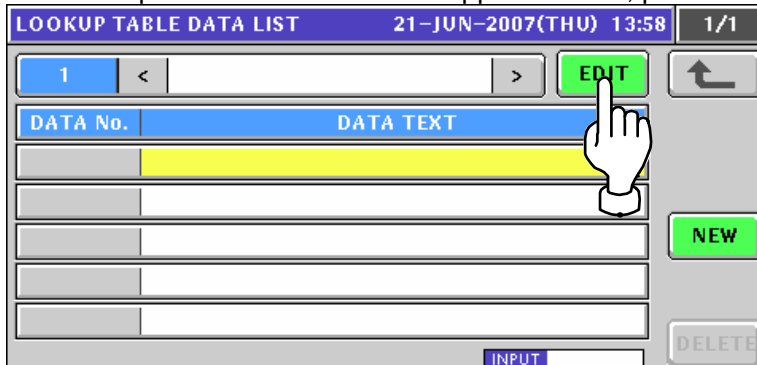

5. The Lookup Header Table Edit screen appears.

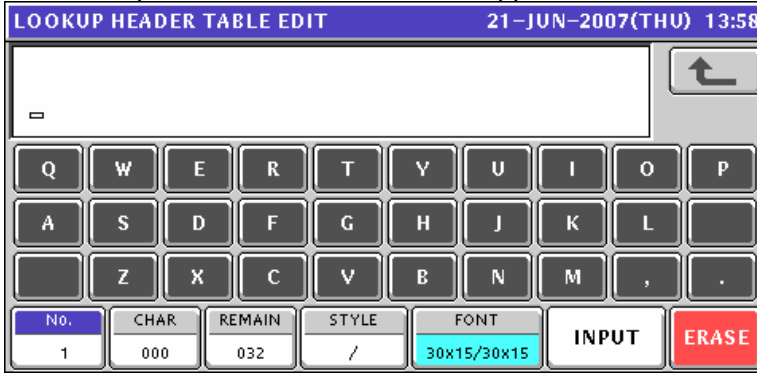

6. Edit a text according to the procedures described in Appendix "Text Editing".

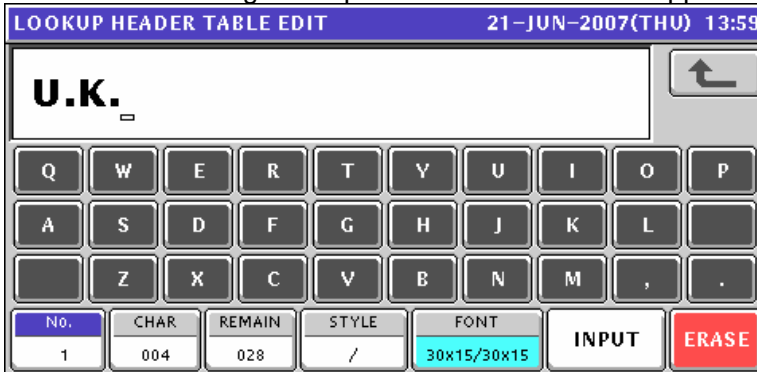

7. Press the [ESC] key on the key sheet to escape from text editing mode.



The confirmation screen appears. Then, press the [SAVE] button.

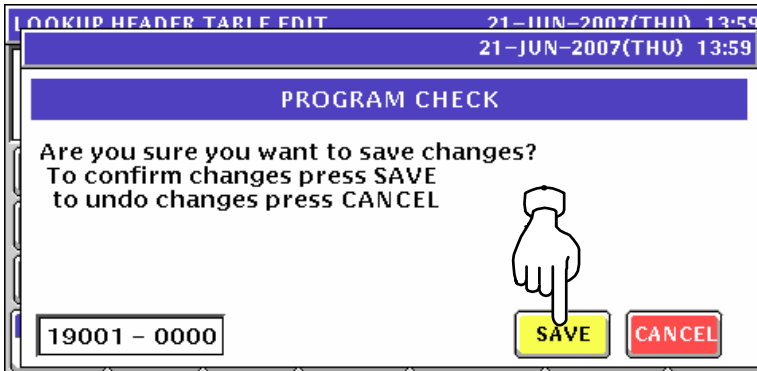

8. The edited text has been registered. Then, press the [NEW] button.

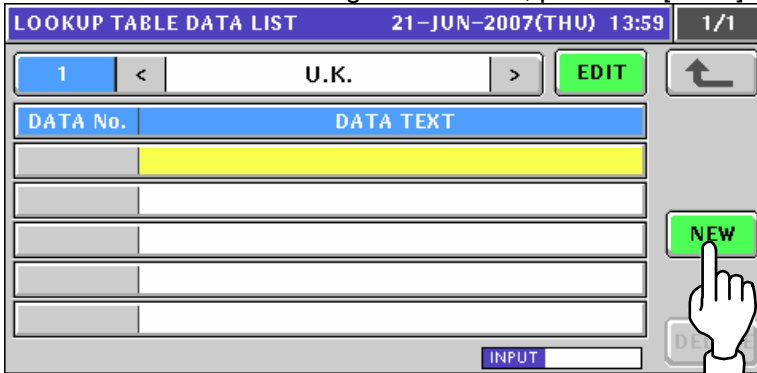

9. The confirmation screen appears. Then, press the [ENTER] button.

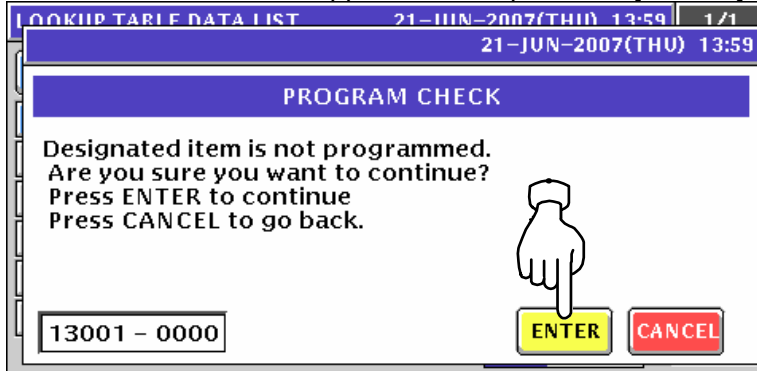

10. The Lookup Data Table Edit screen appears.



11. Edit a text according to the procedures described in Appendix "Text Editing".

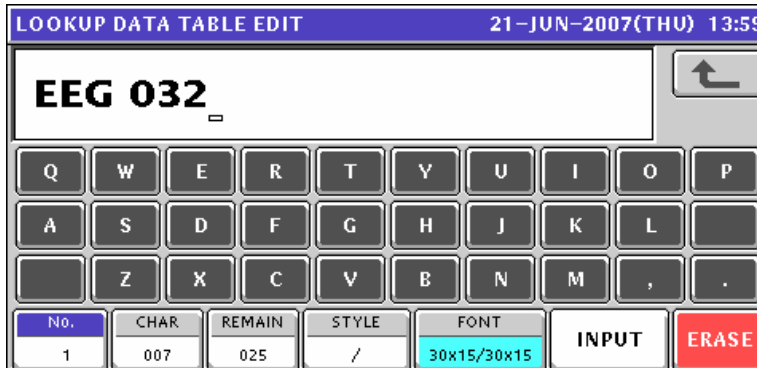

12. Press the [ESC] key on the key sheet to escape from text editing mode.

ESC

The confirmation screen appears. Then, press the [SAVE] button.

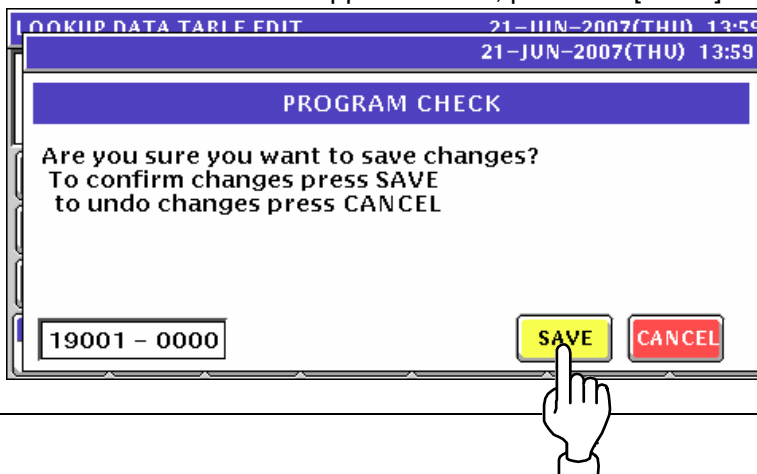

13. The edited text has been registered.

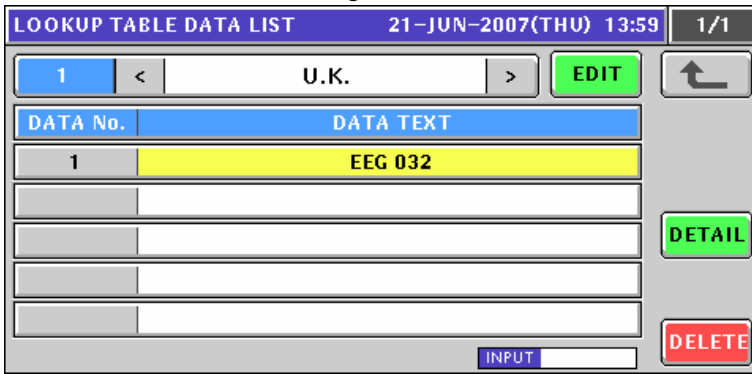

14. When registering the next data text, enter the data number and press the [PLU] key on the key sheet.

EXAMPLE Data number "2".

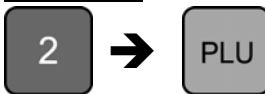

The confirmation screen appears. Then, press the [ENTER] button.

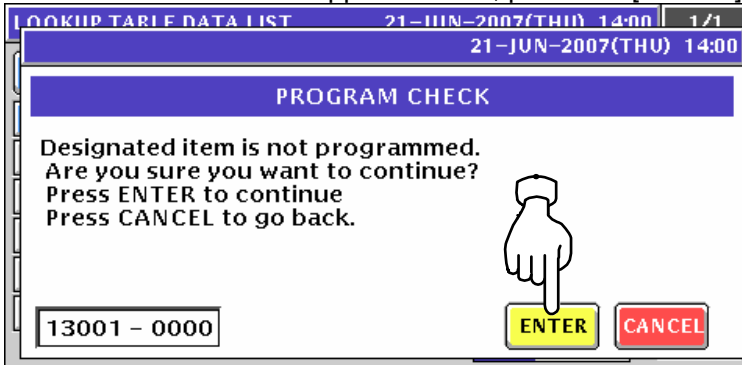

15. The Lookup Data Table Edit screen appears.



16. Edit a text according to the procedures described in Appendix "Text Editing".

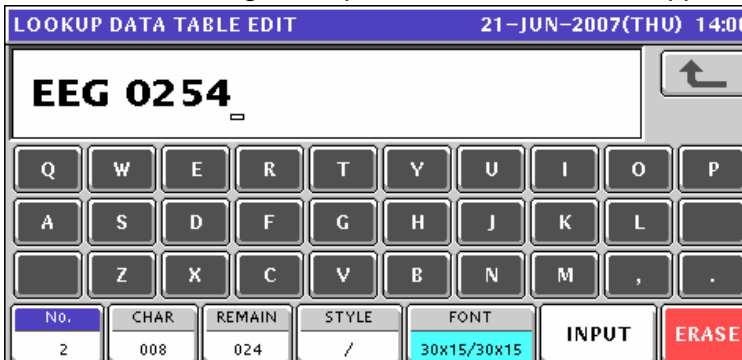

17. Press the [ESC] key on the key sheet to escape from text editing mode.

ESC

The confirmation screen appears. Then, press the [SAVE] button.

18. The edited text has been registered.

19. Repeat steps 14 through 18 for more data registrations.

20. Press the Return button to return to the Lookup Table screen.

21. The Lookup Table screen appears.

22. When registering the next header text, enter the header number and press the [PLU] key on the key sheet.

EXAMPLE Header number “2”.



The confirmation screen appears. Then, press the [ENTER] button.

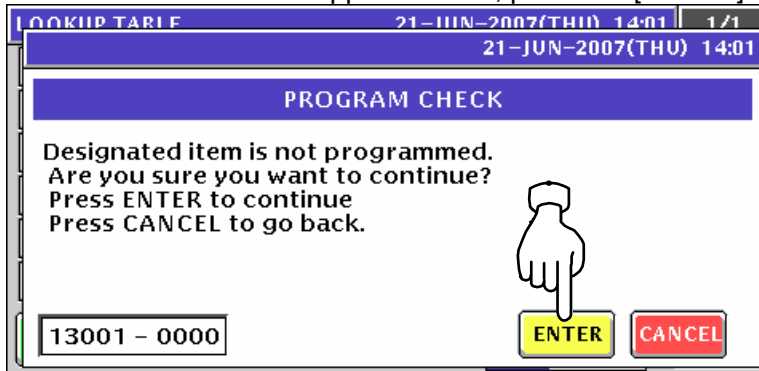

23. The Lookup Table Data List screen appears. Then, press the [EDIT] button.

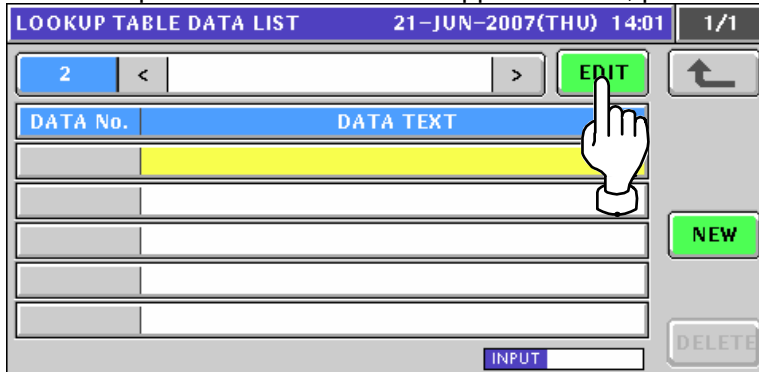

24. The Lookup Header Table Edit screen appears.



25. Edit a text according to the procedures described in Appendix “Text Editing”.



26. Press the [ESC] key on the key sheet to escape from text editing mode.

ESC

The confirmation screen appears. Then, press the [SAVE] button.

LOOKUP HEADER TABLE EDIT 21-JUN-2007(THU) 14:01
21-JUN-2007(THU) 14:01

PROGRAM CHECK

Are you sure you want to save changes?
To confirm changes press SAVE
to undo changes press CANCEL

19001 - 0000

SAVE CANCEL

27. The edited text has been registered. Then, press the Return button.

LOOKUP TABLE DATA LIST 21-JUN-2007(THU) 14:02 1/1

2 < NETHERLANDS > EDIT

DATA No.	DATA TEXT

NEW

DELETE

INPUT

28. The Lookup Table screen appears

LOOKUP TABLE 21-JUN-2007(THU) 14:02 1/1

1	U.K.
2	NETHERLANDS

DETAIL

DELETE

FIND PLU SEARCH

INPUT

29. Repeat steps 22 through 28 for more header registrations.

10.18.2 CHANGING EXISITING TABLES

1. Press the "Lookup Table" field on the Program Menu Select screen.

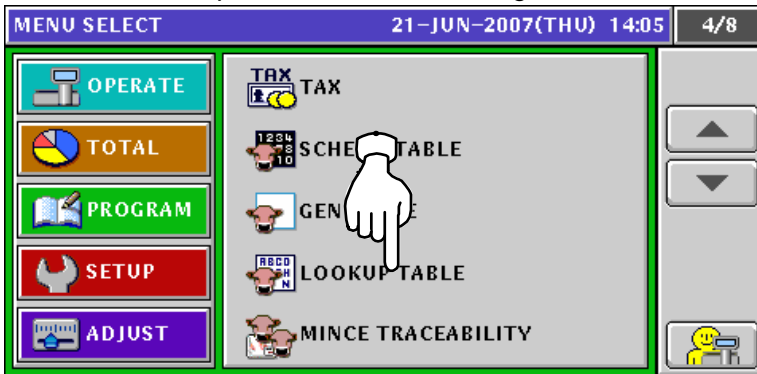

2. The Lookup Table screen appears.



3. Select a desired header table by pressing the corresponding field.

EXAMPLE Table number "2".



or press the [PLU] key on the key sheet after a numeric entry.

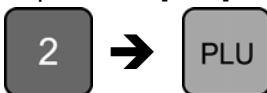

4. Press the [DETAIL] button.

LOOKUP TABLE		21-JUN-2007(THU) 14:05	1/1
1	U.K.		
2	NETHERLANDS		
FIND PLU		SEARCH	INPUT

DETAIL

5. The Lookup Table Data List screen appears.
When changing the header name, press the [EDIT] button

LOOKUP TABLE DATA LIST		21-JUN-2007(THU) 14:05	1/1
2	< NETHERLANDS >	EDIT	
DATA No.	DATA TEXT		
1	EEG 0532		
2	EEG 552		
INPUT		DELETE	

6. The Lookup Header Table Edit screen appears.

LOOKUP HEADER TABLE EDIT		21-JUN-2007(THU) 14:05							
NETHERLANDS									
Q	W	E	R	T	Y	U	I	O	P
A	S	D	F	G	H	J	K	L	
	Z	X	C	V	B	N	M	,	.
No.	CHAR	REMAIN	STYLE	FONT	INPUT	ERASE			
1	011	021	/	30x15/30x15					

7. Edit a text according to the procedures described in Appendix "Text Editing".

LOOKUP HEADER TABLE EDIT		21-JUN-2007(THU) 14:06							
FRANCE									
Q	W	E	R	T	Y	U	I	O	P
A	S	D	F	G	H	J	K	L	
	Z	X	C	V	B	N	M	,	.
No.	CHAR	REMAIN	STYLE	FONT	INPUT	ERASE			
1	005	026	/	30x15/30x15					

8. Press the [ESC] key on the key sheet to escape from text editing mode.



The confirmation screen appears. Then, press the [SAVE] button.

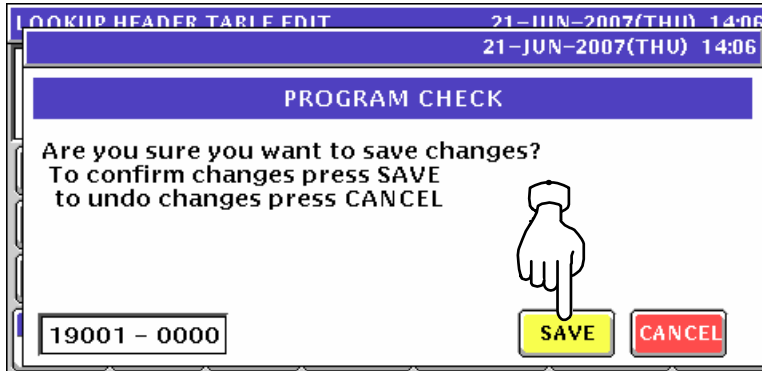

9. The edited text has been registered.

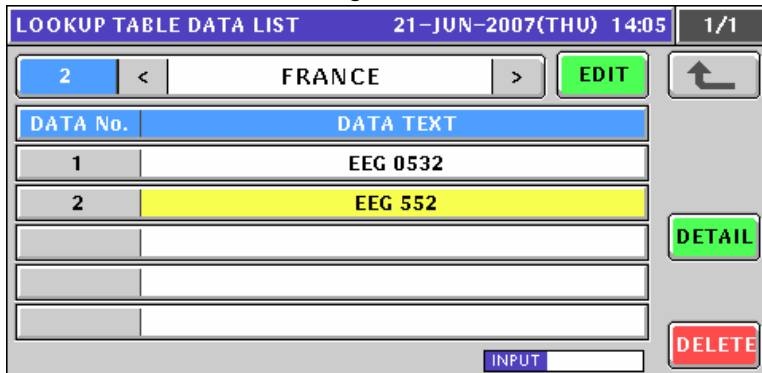

10. When changing the data text, select a desired data text by pressing the corresponding field. and press the [DETAIL] button.

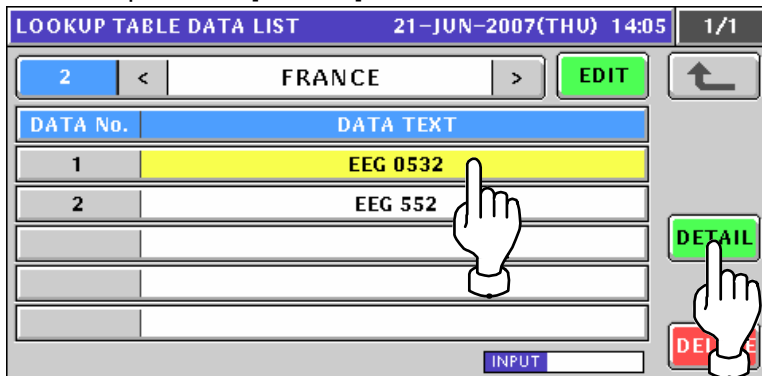

11. The Lookup Data Table Edit screen appears.



12. Edit a text according to the procedures described in Appendix “Text Editing”.

13. Press the [ESC] key on the key sheet to escape from text editing mode.

ESC

The confirmation screen appears. Then, press the [SAVE] button.

14. The edited text has been registered.

DATA No.	DATA TEXT
1	EEG 0254
2	EEG 552

15. Repeat steps 10 through 14 for more data text registrations.

16. Repeat steps 3 through 15 for more header table text registrations.

10.19 MINCE TRACEABILITY REGISTRATION

1. Press the "Mince Traceability" field on the Program Menu Select screen.

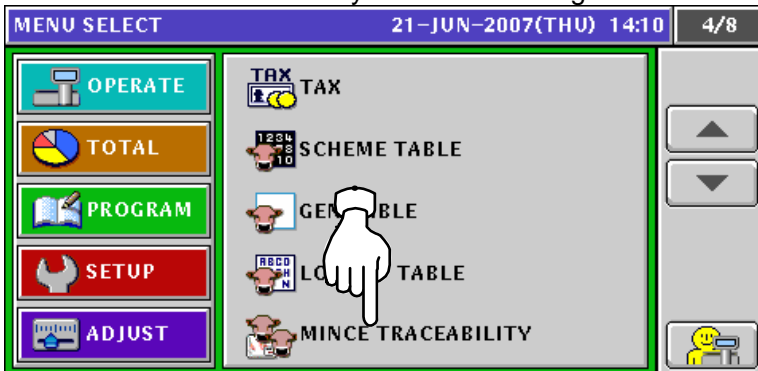

2. The Mince Traceability screen appears.

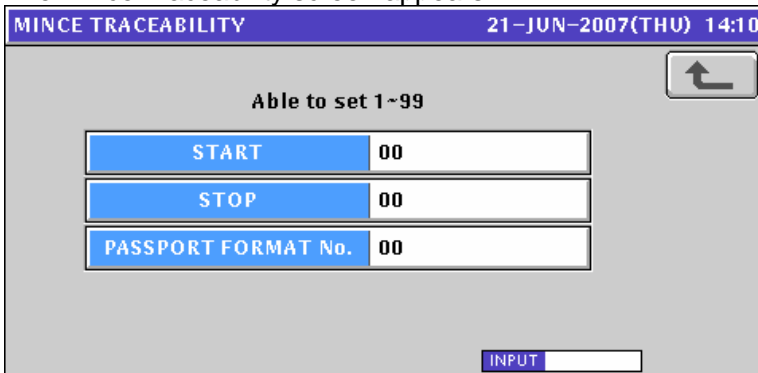

3. Enter a numeric value and press the corresponding field for registration. Then, press the Return button to finalize this procedure.

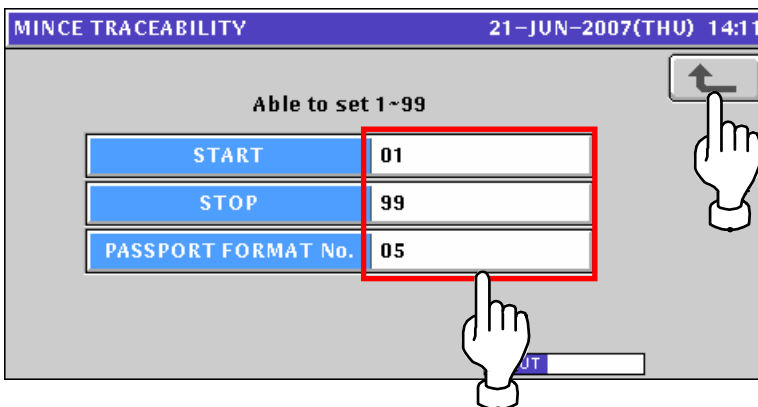

10.20 FIXED PRICE MARK REGISTRATION

10.20.1 CREATING NEW PRICE MARKS

1. Press the "Fixed Mark" field on the Program Menu Select screen.

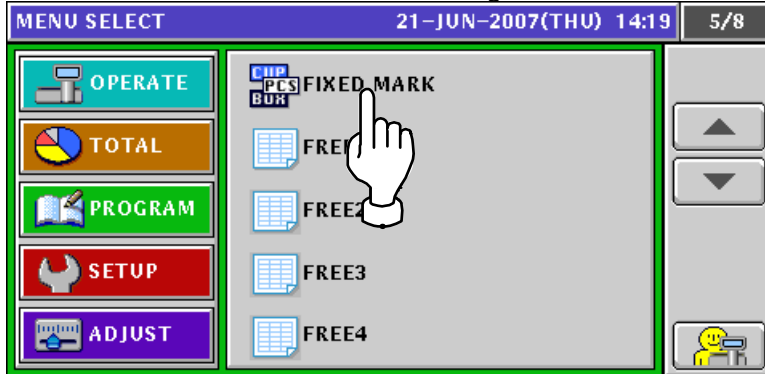

2. The Fix Price Mark List screen appears.

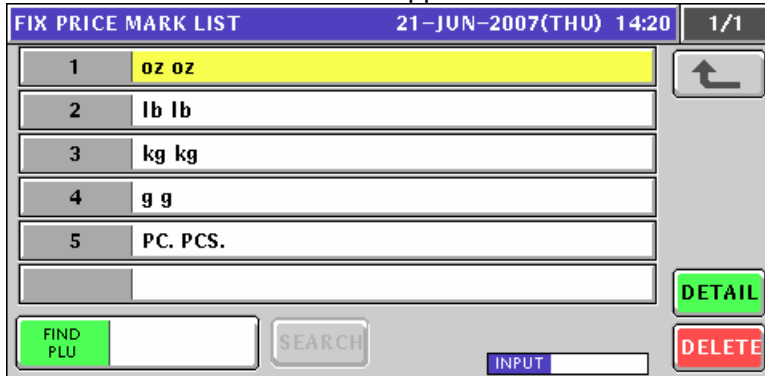

3. Enter a desired mark number using the numeric keys and press the [PLU] key on the key sheet.

EXAMPLE Mark number "6".



The confirmation screen appears. Then, press the [ENTER] button.

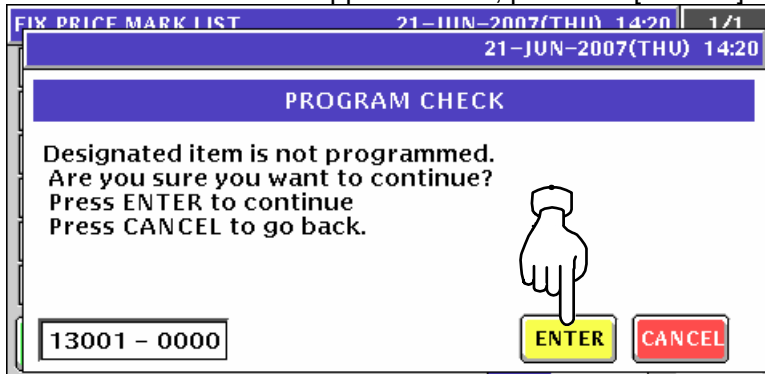

4. The Fix Price Mark Edit screen appears.

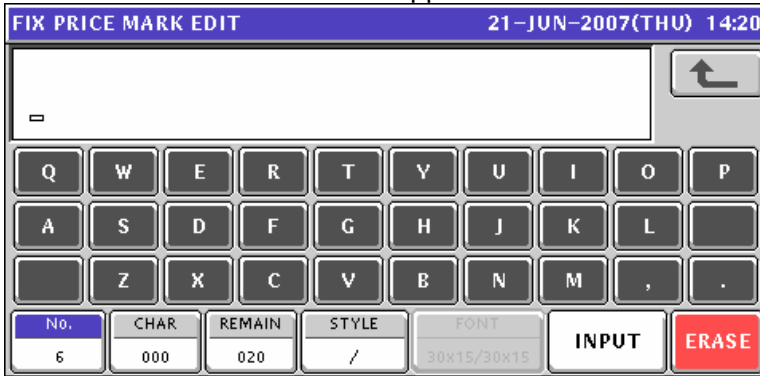

5. Edit a text according to the procedures described in Appendix "Text Editing".



6. Press the [ESC] key on the key sheet to escape from text editing mode.



The confirmation screen appears. Then, press the [SAVE] button.

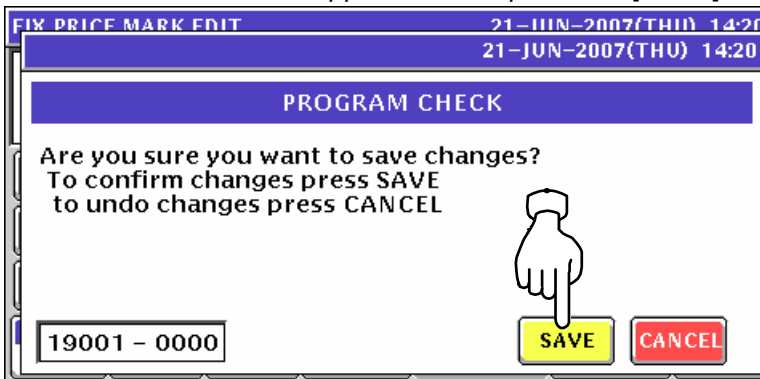

7. The edited text has been registered. To finalize this procedure, press the Return button.

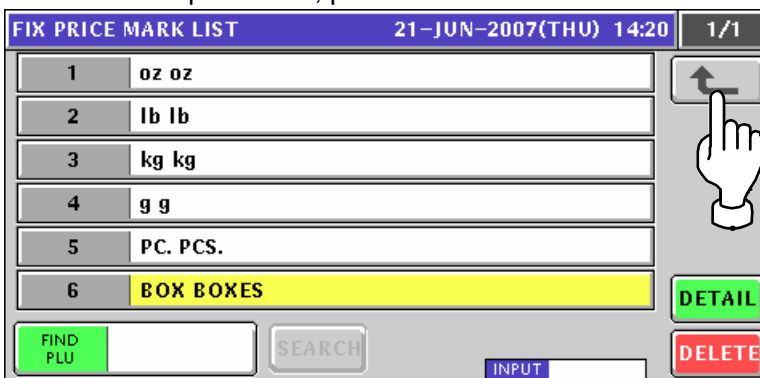

10.20.2 CHANGING EXISTING PRICE MARKS

1. Press the "Fixed Mark" field on the Program Menu Select screen.

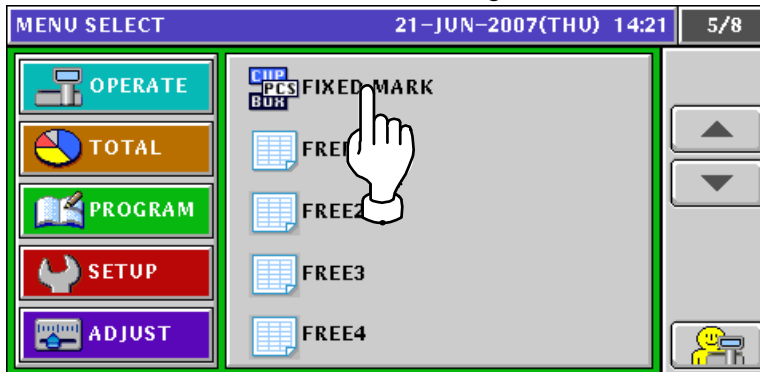

2. Select a desired mark number by pressing the corresponding field.

EXAMPLE Mark number "2".



or press the [PLU] key on the key sheet after a numeric entry.



3. The Fix Price Mark Edit screen appears.



4. Edit a text according to the procedures described in Appendix “Text Editing”.



5. Press the [ESC] key on the key sheet to escape from text editing mode.



The confirmation screen appears. Then, press the [SAVE] button.

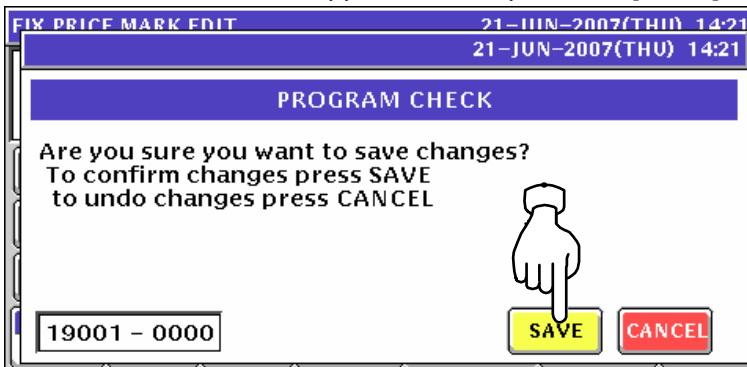

6. The edited text has been registered.

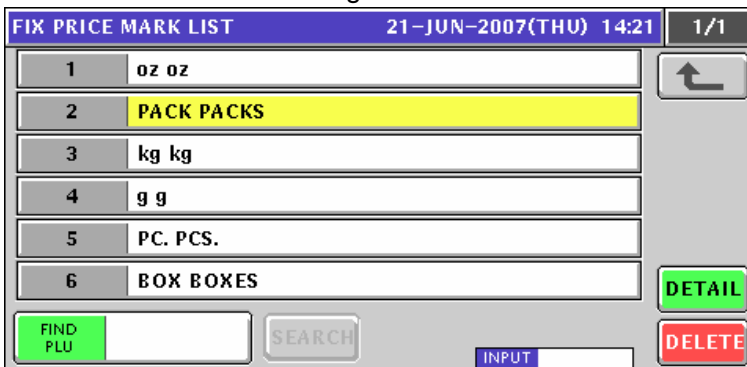

7. Repeat steps 2 through 6 for more registrations.

10.21 FREE MESSAGE REGISTRATION

10.21.1 CREATING NEW MESSAGES

1. Press the "Free" field on the Program Menu Select screen.

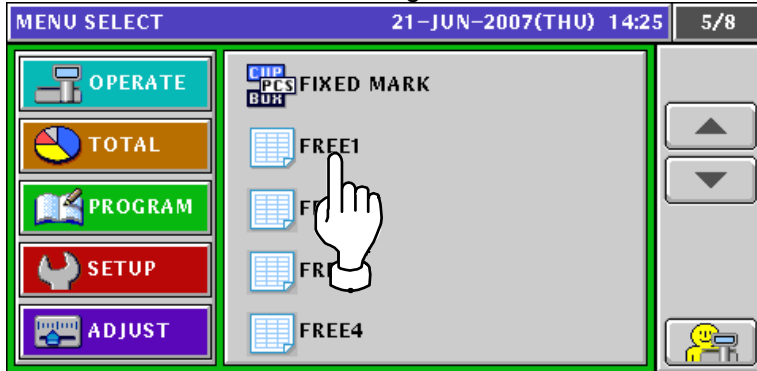

2. The Free Message List screen appears. Then, press the [NEW] button.

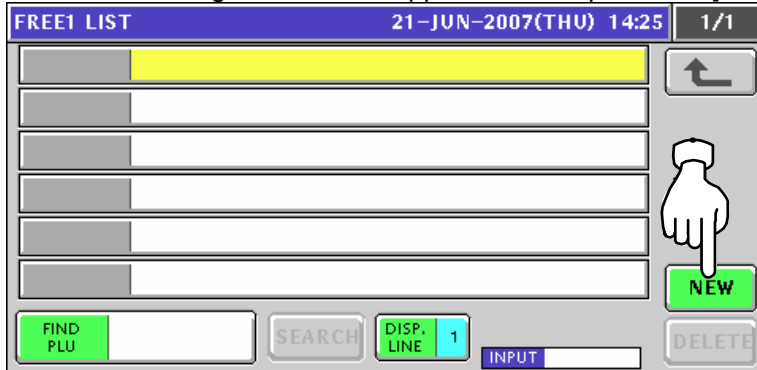

3. The confirmation screen appears. Then, press the [ENTER] button.

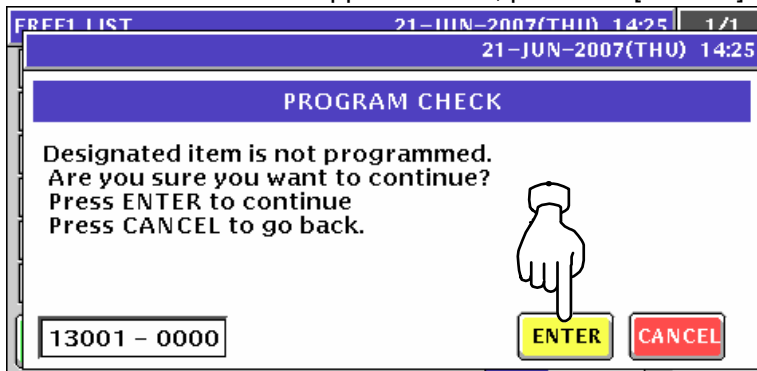

4. The Free Message Edit screen appears.



5. Edit a text according to the procedures described in Appendix "Text Editing".

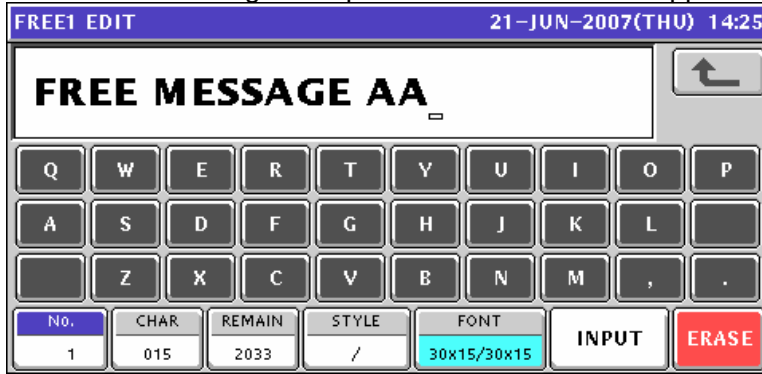

6. Press the [ESC] key on the key sheet to escape from text editing mode.



The confirmation screen appears. Then, press the [SAVE] button.

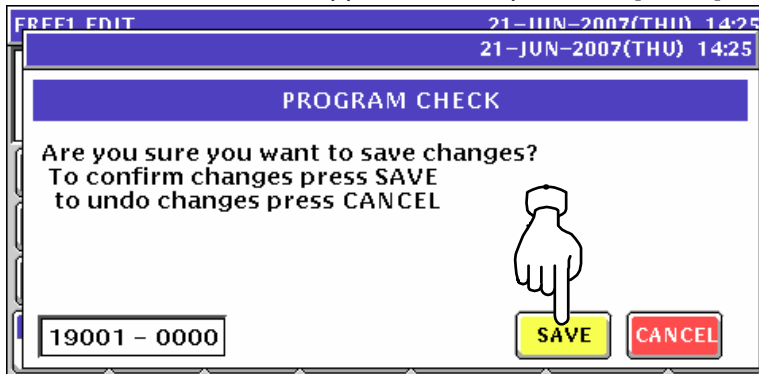

7. The edited text has been registered.

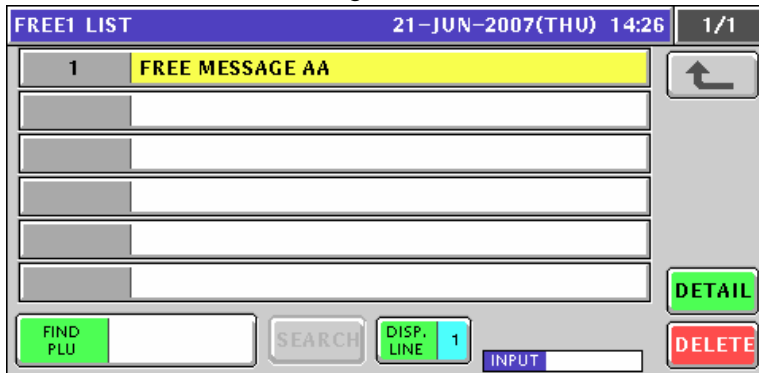

8. Enter a desired message number using the numeric keys and press the [PLU] key on the key sheet.

EXAMPLE Message number "2".



Enter a desired message number using the numeric keys and press the [PLU] key on the key sheet.

EXAMPLE Message number "2".



The confirmation screen appears. Then, press the [ENTER] button.

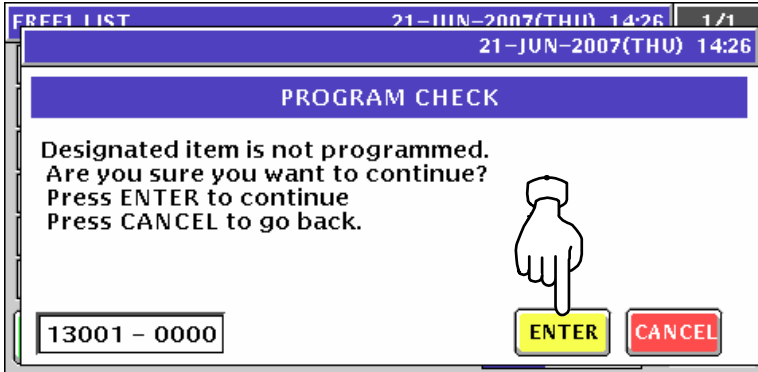

9. Repeat steps 4 through 8 for more registrations.

10.21.2 CHANGING EXISITING MESSAGES

1. Press the "Fixed Mark" field on the Program Menu Select screen.

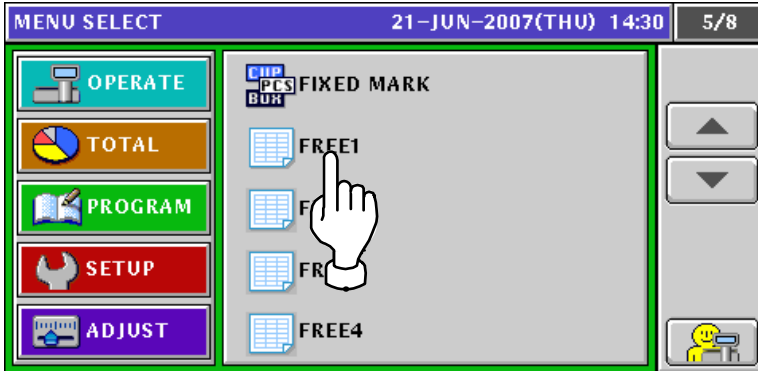

2. The Free Message List screen appears.

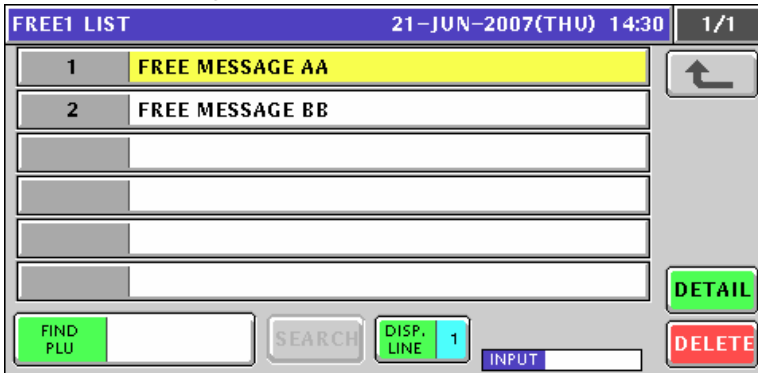

3. Select a desired message number by pressing the corresponding field.

EXAMPLE Message number "2".



or press the [PLU] key on the key sheet after a numeric entry.



4. The Free Message Edit screen appears.

5. Edit a text according to the procedures described in Appendix “Text Editing”.

6. Press the [ESC] key on the key sheet to escape from text editing mode.

ESC

The confirmation screen appears. Then, press the [SAVE] button.

7. The edited text has been registered.

8. Repeat steps 3 through 7 for more registrations.

10.22 CHECK LABEL REGISTRATION

1. Press the "Check Label" field on the Program Menu Select screen.

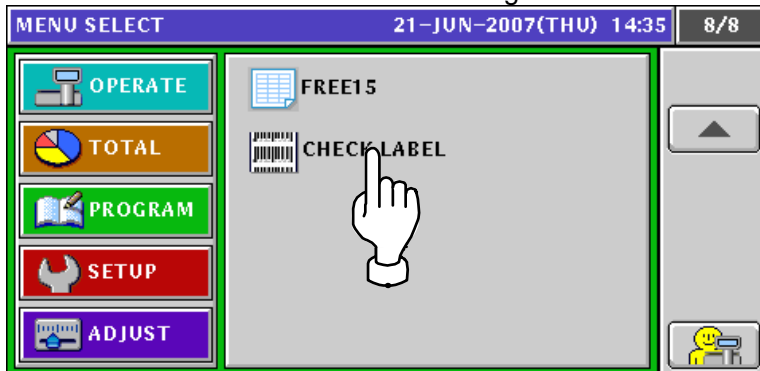

2. The Check Label screen appears.

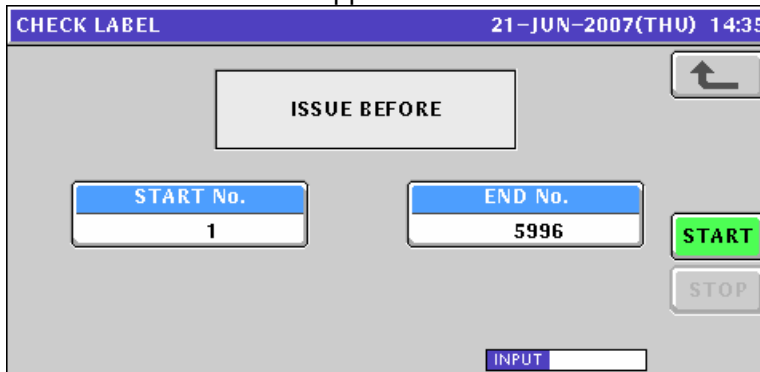

3. Enter Start Number and End Number using the numeric keys and press the corresponding fields for registration.

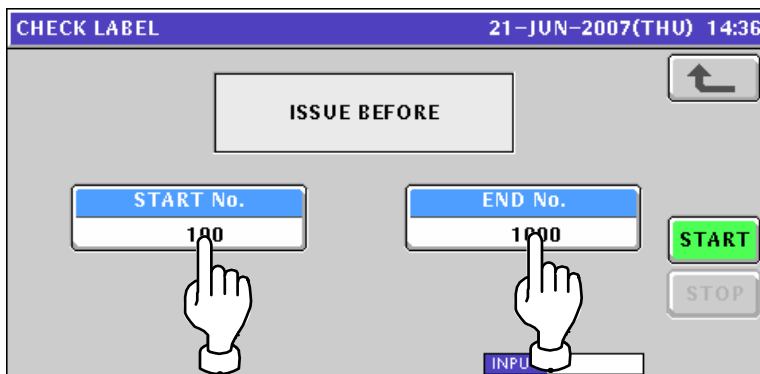

4. Press the [START] button to print the labels.

CHECK LABEL 21-JUN-2007(THU) 14:36

ISSUE BEFORE

START No. 100

END No. 1000

START

INPUT



SETUP MODE

11.1 SETUP MODE ENTRY

1. Make sure that the initial screen is displayed.

PLU 0					21-JUN-2007(THU) 15:03		TARE	kg
Check the weight before operation. Enter PLU No. and press [PLU] key.							0.000	
							ZERO	WEIGHT kg
							0.000	
							UNIT PRICE	£/kg
							0.00	
							TOTAL PRICE	£
							0.00	

GROUND BEEF (TEXAS)	GROUND BEEF (OREGON)	GROUND BEEF (UTAH)	SLICED BEEF	SLICED BEEF SPECIAL		
ROAST BEEF	ROAST BEEF SPECIAL	LAMB CHOPS	LAMB CHOPS SPECIAL	T-BONE STEAK		
OPERATOR GROUP	PRN MD. <AUTO>	CASSETTE 1	SUBTOTAL DISPLAY			

2. Press the [MODE] key on the key sheet.

Mode

The Operation Mode screen appears. Then, press the [SETUP] button on the screen

MENU SELECT		21-JUN-2007(THU) 15:03		1/1
	OPERATE		SALES	
	TOTAL		ACC1	
	GRAM		ACC2	
	SETUP		ACC3	
	ADJUST		TOTAL ADJUST	

3. The Setup Menu Select screen appears.
To change the pages, press the [▼] or [▲] button on the screen.

MENU SELECT		21-JUN-2007(THU) 15:03		1/2
	OPERATE		MACHINE No.	
	TOTAL		SALES MODE	
	PROGRAM		PASSWORD	
	SETUP		KEY LOCK	
	ADJUST		DATA STORAGE	

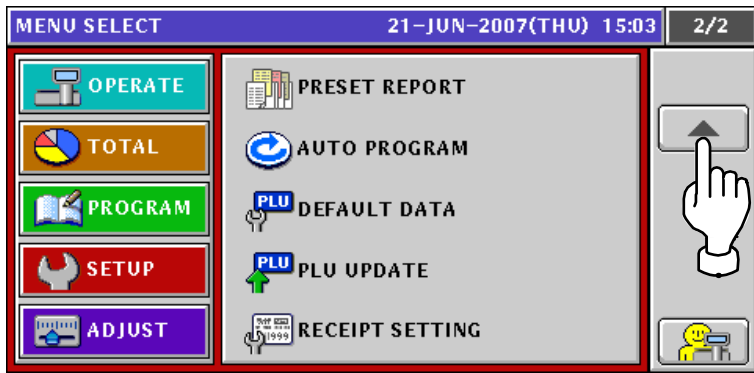

11.2 MACHINE NUMBER SETTING

1. Press the "MACHINE No." field on the Setup Menu Select screen.



2. The Machine Number (Basis) screen appears.

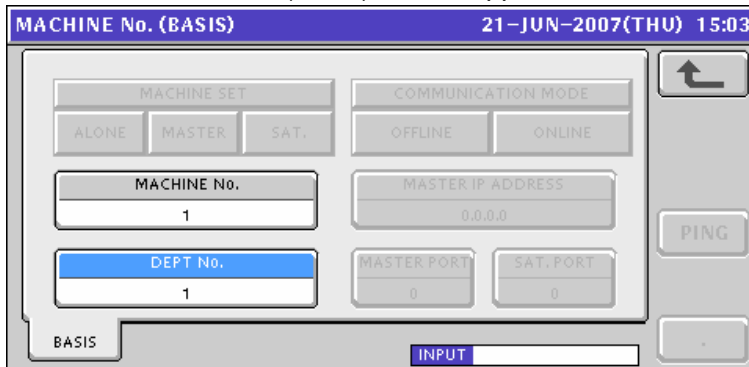

3. Enter a desired numeric value and press the "Dept No." field.

EXAMPLE Dept number "9"

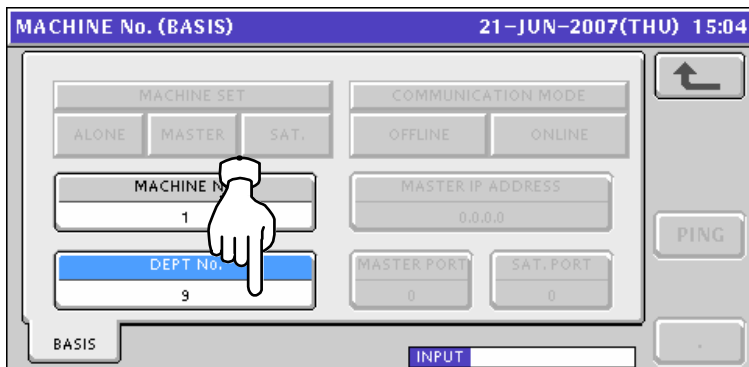

4. The confirmation screen appears. Then, press the [EXEC] button to continue.

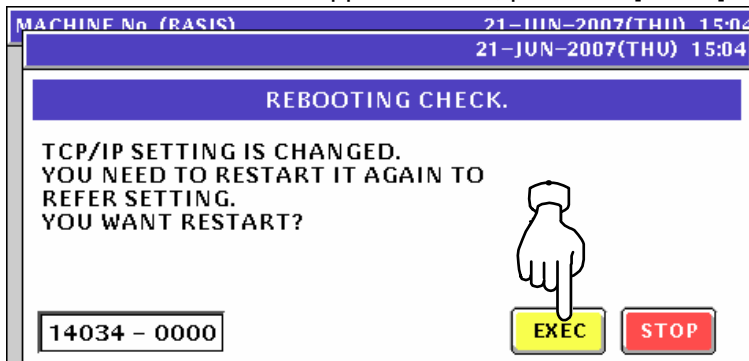

11.3 SALES MODE SETTING

1. Press the "Sales Mode" field on the Setup Menu Select screen.

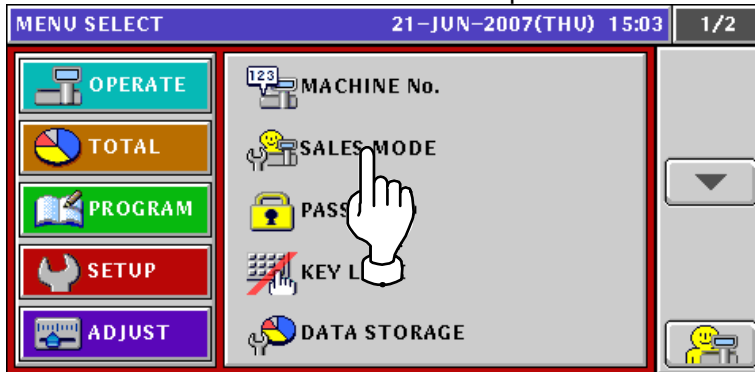

2. The Sales Mode screen appears.

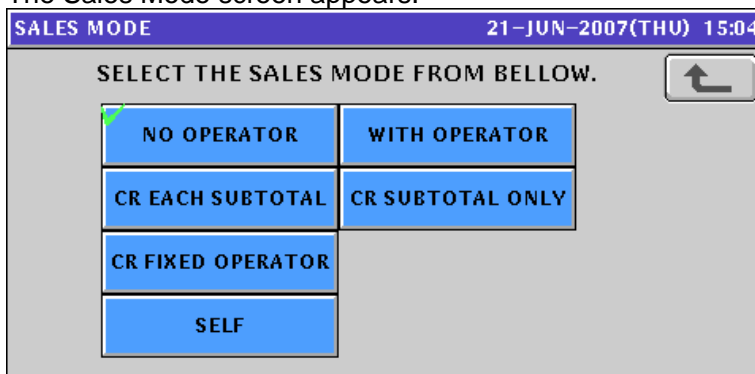

3. Select a desired mode by pressing the corresponding button.

EXAMPLE "Self-service Mode"

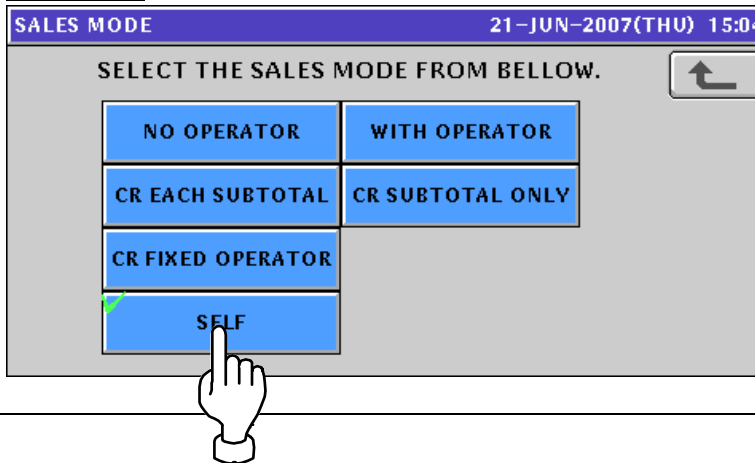

11.4 PASSWORD SETTING

1. Press the "Password" field on the Setup Menu Select screen.



2. The Password (Operate) screen appears. To change the pages, press the [▼] or [▲] button on the screen.

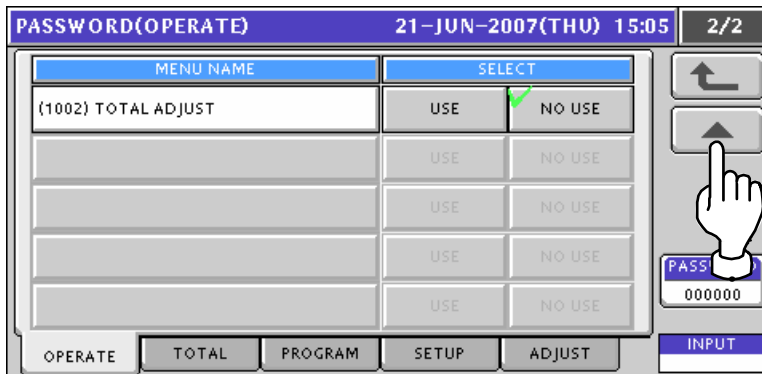
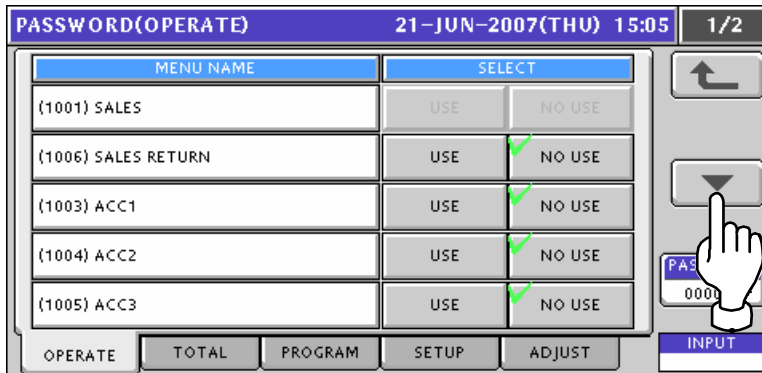

3. Press the [TOTAL] tab to display the Password (Total) screen. To change the pages, press the [▼] or [▲] button on the screen.

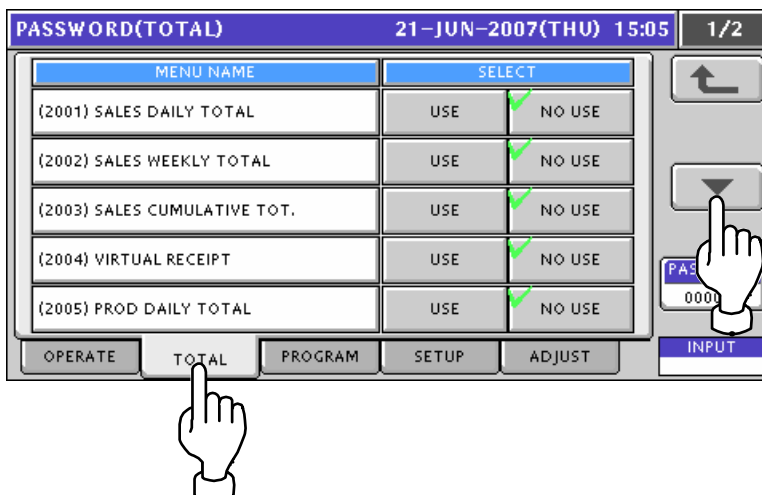

PASSWORD(TOTAL)		21-JUN-2007(THU) 15:05		2/2
MENU NAME	SELECT			
(2006) PROD WEEKLY TOTAL	USE	<input checked="" type="checkbox"/>	NO USE	<input type="button" value="↶"/> <input type="button" value="▲"/> <input type="button" value="▼"/> <input type="button" value="↷"/> <input type="text" value="PASS 000000"/> <input type="button" value="INPUT"/>
(2007) PROD CUMULATIVE TOTAL	USE	<input checked="" type="checkbox"/>	NO USE	
(2008) TRACEABILITY TOTAL	USE	<input checked="" type="checkbox"/>	NO USE	
(2009) PRESET REPORT	USE	<input checked="" type="checkbox"/>	NO USE	
(2010) TOTAL CLEAR	USE	<input checked="" type="checkbox"/>	NO USE	
<input type="button" value="OPERATE"/> <input type="button" value="TOTAL"/> <input type="button" value="PROGRAM"/> <input type="button" value="SETUP"/> <input type="button" value="ADJUST"/>				

4. Press the [PROGRAM] tab to display the Password (Program) screen. To change the pages, press the [▼] or [▲] button on the screen.

PASSWORD(PROGRAM)		21-JUN-2007(THU) 15:05		1/8
MENU NAME	SELECT			
(3001) PLU FILE	USE	<input checked="" type="checkbox"/>	NO USE	<input type="button" value="↶"/> <input type="button" value="▲"/> <input type="button" value="▼"/> <input type="button" value="↷"/> <input type="text" value="PAS 0000"/> <input type="button" value="INPUT"/>
(3002) CAMPAIGN	USE	<input checked="" type="checkbox"/>	NO USE	
(3006) OPERATORS	USE	<input checked="" type="checkbox"/>	NO USE	
(3004) PRESET KEY	USE	<input checked="" type="checkbox"/>	NO USE	
(3005) AD MSG	USE	<input checked="" type="checkbox"/>	NO USE	
<input type="button" value="OPERATE"/> <input type="button" value="TOTAL"/> <input type="button" value="PROGRAM"/> <input type="button" value="SETUP"/> <input type="button" value="ADJUST"/>				

PASSWORD(PROGRAM)		21-JUN-2007(THU) 15:05		2/8
MENU NAME	SELECT			
(3003) STORE NAME	USE	<input checked="" type="checkbox"/>	NO USE	<input type="button" value="↶"/> <input type="button" value="▲"/> <input type="button" value="▼"/> <input type="button" value="↷"/> <input type="text" value="PAS 0000"/> <input type="button" value="INPUT"/>
(3012) DEPARTMENT	USE	<input checked="" type="checkbox"/>	NO USE	
(3013) GROUP	USE	<input checked="" type="checkbox"/>	NO USE	
(3019) COOKING INSTRUCTION	USE	<input checked="" type="checkbox"/>	NO USE	
(3007) NUTRITION(USA)	USE	<input checked="" type="checkbox"/>	NO USE	
<input type="button" value="OPERATE"/> <input type="button" value="TOTAL"/> <input type="button" value="PROGRAM"/> <input type="button" value="SETUP"/> <input type="button" value="ADJUST"/>				

PASSWORD(PROGRAM)		21-JUN-2007(THU) 15:05		3/8
MENU NAME	SELECT			
(3008) EXTRA MESSAGE1	USE	<input checked="" type="checkbox"/>	NO USE	<input type="button" value="↶"/> <input type="button" value="▲"/> <input type="button" value="▼"/> <input type="button" value="↷"/> <input type="text" value="PAS 0000"/> <input type="button" value="INPUT"/>
(3009) EXTRA MESSAGE2	USE	<input checked="" type="checkbox"/>	NO USE	
(3010) EXTRA MESSAGE3	USE	<input checked="" type="checkbox"/>	NO USE	
(3011) COUPON MESSAGE	USE	<input checked="" type="checkbox"/>	NO USE	
(3014) POP MESSAGE	USE	<input checked="" type="checkbox"/>	NO USE	
<input type="button" value="OPERATE"/> <input type="button" value="TOTAL"/> <input type="button" value="PROGRAM"/> <input type="button" value="SETUP"/> <input type="button" value="ADJUST"/>				

PASSWORD(PROGRAM) 21-JUN-2007(THU) 15:05 4/8

MENU NAME	SELECT	
(3037) TAX	USE	NO USE
(3016) SCHEME TABLE	USE	NO USE
(3017) GEN TABLE	USE	NO USE
(3018) LOOKUP TABLE	USE	NO USE
(3036) MINCE TRACEABILITY	USE	NO USE

OPERATE TOTAL PROGRAM SETUP ADJUST INPUT

PASS 0000



PASSWORD(PROGRAM) 21-JUN-2007(THU) 15:05 5/8

MENU NAME	SELECT	
(3035) FIXED MARK	USE	NO USE
(3020) FREE1	USE	NO USE
(3021) FREE2	USE	NO USE
(3022) FREE3	USE	NO USE
(3023) FREE4	USE	NO USE

OPERATE TOTAL PROGRAM SETUP ADJUST INPUT

PASS 0000



PASSWORD(PROGRAM) 21-JUN-2007(THU) 15:06 6/8

MENU NAME	SELECT	
(3024) FREE5	USE	NO USE
(3025) FREE6	USE	NO USE
(3026) FREE7	USE	NO USE
(3027) FREE8	USE	NO USE
(3028) FREE9	USE	NO USE

OPERATE TOTAL PROGRAM SETUP ADJUST INPUT

PASS 0000



PASSWORD(PROGRAM) 21-JUN-2007(THU) 15:06 7/8

MENU NAME	SELECT	
(3029) FREE10	USE	NO USE
(3030) FREE11	USE	NO USE
(3031) FREE12	USE	NO USE
(3032) FREE13	USE	NO USE
(3033) FREE14	USE	NO USE

OPERATE TOTAL PROGRAM SETUP ADJUST INPUT

PASS 0000



PASSWORD(PROGRAM) 21-JUN-2007(THU) 15:06 8/8

MENU NAME	SELECT	
(3034) FREE15	USE	NO USE
(3015) CHECK LABEL	USE	NO USE
	USE	NO USE
	USE	NO USE
	USE	NO USE

OPERATE TOTAL PROGRAM SETUP ADJUST INPUT

PASS 000000



- Press the [SETUP] tab to display the Password (Setup) screen. To change the pages, press the [▼] or [▲] button on the screen.

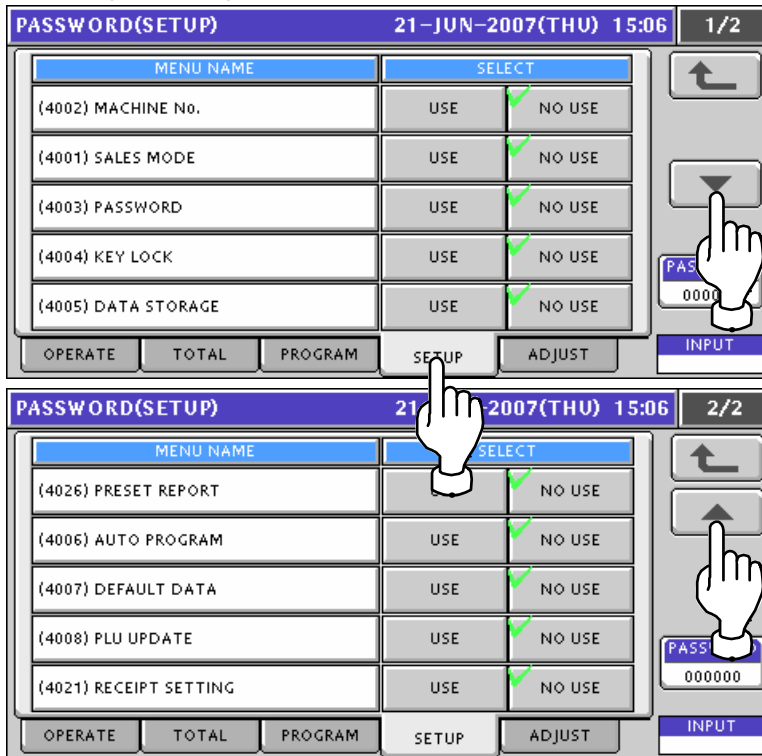

- Press the [ADJUST] tab to display the Password (Adjust) screen.

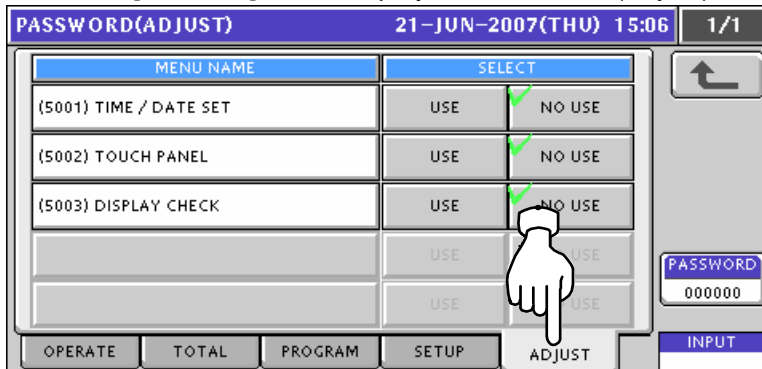

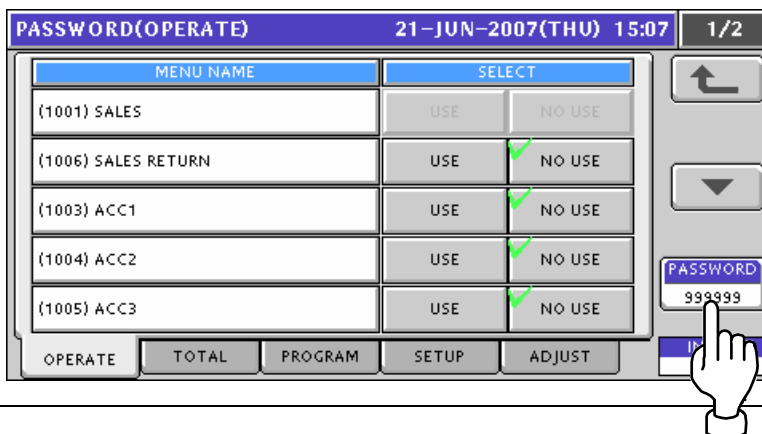

- Enter a 6-digit password using the numeric keys and press the [PASSWORD] display field on the screen.

EXAMPLE Password "999999"





8. Press desired buttons to set whether or not to use the password.

EXAMPLE Set to apply the password to “Virtual Receipt” in Total Mode.

PASSWORD(TOTAL)		21-JUN-2007(THU) 15:07		1/2
MENU NAME	SELECT			
(2001) SALES DAILY TOTAL	USE	<input checked="" type="checkbox"/>	NO USE	
(2002) SALES WEEKLY TOTAL	USE	<input checked="" type="checkbox"/>	NO USE	
(2003) SALES CUMULATIVE TOT.	USE	<input checked="" type="checkbox"/>	NO USE	
(2004) VIRTUAL RECEIPT	<input checked="" type="checkbox"/> USE		NO USE	PASSWORD
(2005) PROD DAILY TOTAL	USE	<input checked="" type="checkbox"/>	NO USE	999999

OPERATE TOTAL PROGRAM SE ADJUST INPUT



11.5 KEY LOCK SETTING

1. Press the "Key Lock" field on the Setup Menu Select screen.

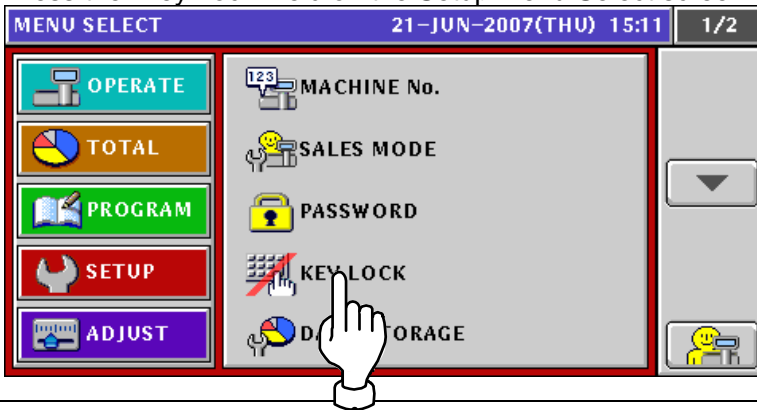

2. The Key Lock (Display Key) screen appears.

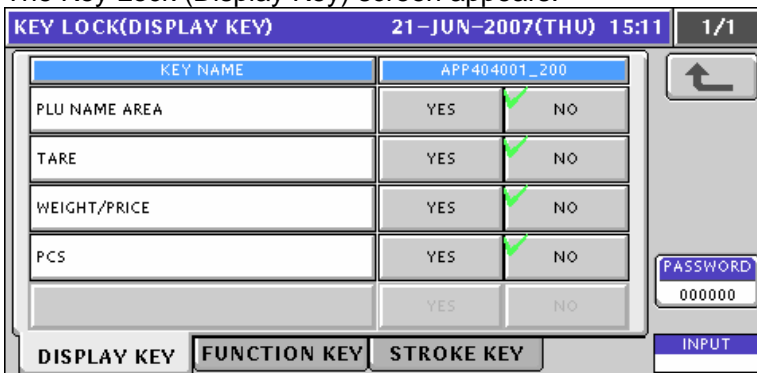

3. Press the [FUNCTION KEY] tab to display the Key Lock (Function Key) screen. Press the [▼] or [▲] button to change the pages.

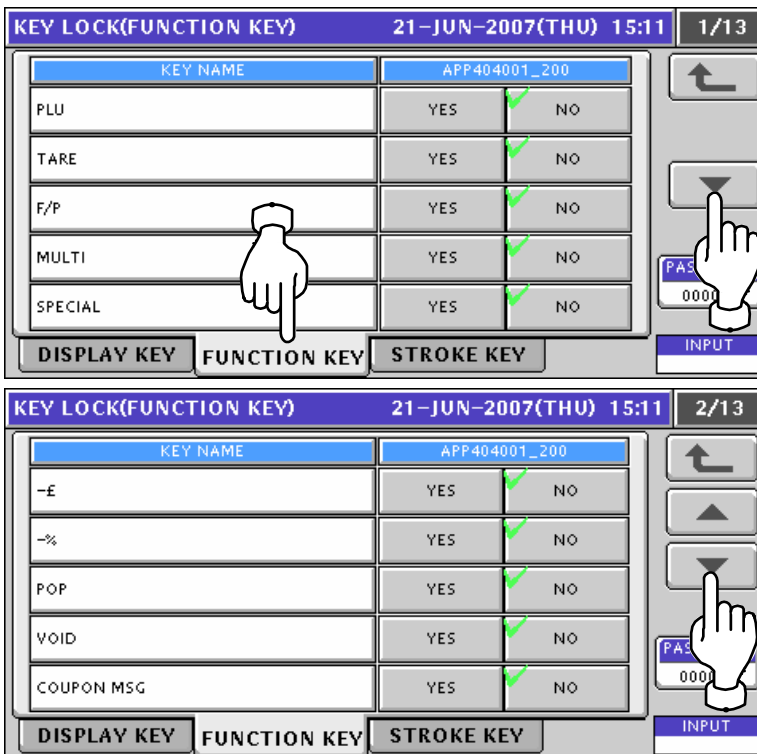

KEY LOCK(FUNCTION KEY)		21-JUN-2007(THU) 15:12		3/13
KEY NAME	APP404001_200			
SUBTOTAL DISPLAY	YES	<input checked="" type="checkbox"/>	NO	
EXTRA1	YES	<input checked="" type="checkbox"/>	NO	
EXTRA2	YES	<input checked="" type="checkbox"/>	NO	
EXTRA3	YES	<input checked="" type="checkbox"/>	NO	
FORMAT	YES	<input checked="" type="checkbox"/>	NO	
DISPLAY KEY		FUNCTION KEY		STROKE KEY
				INPUT

KEY LOCK(FUNCTION KEY)		21-JUN-2007(THU) 15:12		4/13
KEY NAME	APP404001_200			
IMAGE1	YES	<input checked="" type="checkbox"/>	NO	
IMAGE2	YES	<input checked="" type="checkbox"/>	NO	
-E(U/P)	YES	<input checked="" type="checkbox"/>	NO	
PEEL MD.	YES	<input checked="" type="checkbox"/>	NO	
OPERATOR	YES	<input checked="" type="checkbox"/>	NO	
DISPLAY KEY		FUNCTION KEY		STROKE KEY
				INPUT

KEY LOCK(FUNCTION KEY)		21-JUN-2007(THU) 15:12		5/13
KEY NAME	APP404001_200			
PRINT	YES	<input checked="" type="checkbox"/>	NO	
FEED	YES	<input checked="" type="checkbox"/>	NO	
U/P	YES	<input checked="" type="checkbox"/>	NO	
P DATE	YES	<input checked="" type="checkbox"/>	NO	
S DATE	YES	<input checked="" type="checkbox"/>	NO	
DISPLAY KEY		FUNCTION KEY		STROKE KEY
				INPUT

KEY LOCK(FUNCTION KEY)		21-JUN-2007(THU) 15:12		6/13
KEY NAME	APP404001_200			
OPEN DRAWER	YES	<input checked="" type="checkbox"/>	NO	
BAR Y/N	YES	<input checked="" type="checkbox"/>	NO	
TOTAL DISPLAY	YES	<input checked="" type="checkbox"/>	NO	
CALCULATOR	YES	<input checked="" type="checkbox"/>	NO	
IMAGE3	YES	<input checked="" type="checkbox"/>	NO	
DISPLAY KEY		FUNCTION KEY		STROKE KEY
				INPUT

KEY LOCK(FUNCTION KEY)		21-JUN-2007(THU) 15:12		7/13
KEY NAME	APP404001_200			
FREE1	YES	<input checked="" type="checkbox"/>	NO	
FREE2	YES	<input checked="" type="checkbox"/>	NO	
FREE3	YES	<input checked="" type="checkbox"/>	NO	
FREE4	YES	<input checked="" type="checkbox"/>	NO	
FREE5	YES	<input checked="" type="checkbox"/>	NO	
DISPLAY KEY		FUNCTION KEY		STROKE KEY
				INPUT

KEY LOCK(FUNCTION KEY) 21-JUN-2007(THU) 15:12 8/13

KEY NAME	APP404001_200	
FREE6	YES	<input checked="" type="checkbox"/> NO
FREE7	YES	<input checked="" type="checkbox"/> NO
FREE8	YES	<input checked="" type="checkbox"/> NO
FREE9	YES	<input checked="" type="checkbox"/> NO
FREE10	YES	<input checked="" type="checkbox"/> NO

DISPLAY KEY FUNCTION KEY STROKE KEY INPUT

KEY LOCK(FUNCTION KEY) 21-JUN-2007(THU) 15:12 9/13

KEY NAME	APP404001_200	
FREE11	YES	<input checked="" type="checkbox"/> NO
FREE12	YES	<input checked="" type="checkbox"/> NO
FREE13	YES	<input checked="" type="checkbox"/> NO
FREE14	YES	<input checked="" type="checkbox"/> NO
FREE15	YES	<input checked="" type="checkbox"/> NO

DISPLAY KEY FUNCTION KEY STROKE KEY INPUT

KEY LOCK(FUNCTION KEY) 21-JUN-2007(THU) 15:12 10/13

KEY NAME	APP404001_200	
GROUP SELECT	YES	<input checked="" type="checkbox"/> NO
RECEIPT COPY	YES	<input checked="" type="checkbox"/> NO
CATEGORY SELECT	YES	<input checked="" type="checkbox"/> NO
2nd LABEL ONLY PRINT	YES	<input checked="" type="checkbox"/> NO
CASSETTE	YES	<input checked="" type="checkbox"/> NO

DISPLAY KEY FUNCTION KEY STROKE KEY INPUT

KEY LOCK(FUNCTION KEY) 21-JUN-2007(THU) 15:12 11/13

KEY NAME	APP404001_200	
FIX UPR	YES	<input checked="" type="checkbox"/> NO
ERROR LOG	YES	<input checked="" type="checkbox"/> NO
KEY LOCK	YES	<input checked="" type="checkbox"/> NO
AUTO PRINT MODE	YES	<input checked="" type="checkbox"/> NO
PLU No.	YES	<input checked="" type="checkbox"/> NO

DISPLAY KEY FUNCTION KEY STROKE KEY INPUT

KEY LOCK(FUNCTION KEY) 21-JUN-2007(THU) 15:12 12/13

KEY NAME	APP404001_200	
1/2	YES	<input checked="" type="checkbox"/> NO
TOTAL ADD	YES	<input checked="" type="checkbox"/> NO
TRACE	YES	<input checked="" type="checkbox"/> NO
FUNCTION GROUP	YES	<input checked="" type="checkbox"/> NO
OPERATOR GROUP	YES	<input checked="" type="checkbox"/> NO

DISPLAY KEY FUNCTION KEY STROKE KEY INPUT

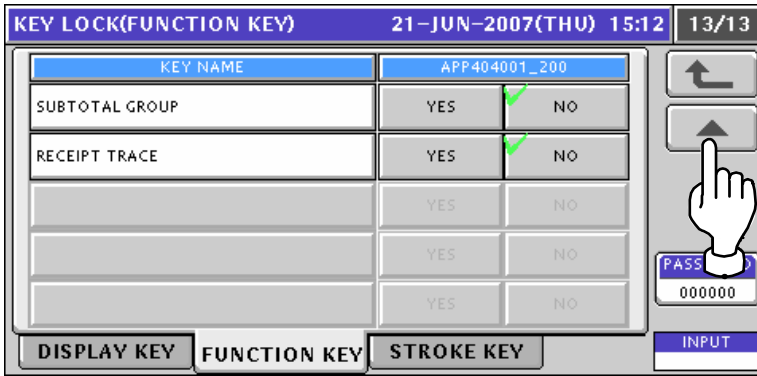

4 Press the [STROKE KEY] tab to display the Key Lock (Stroke Key) screen.

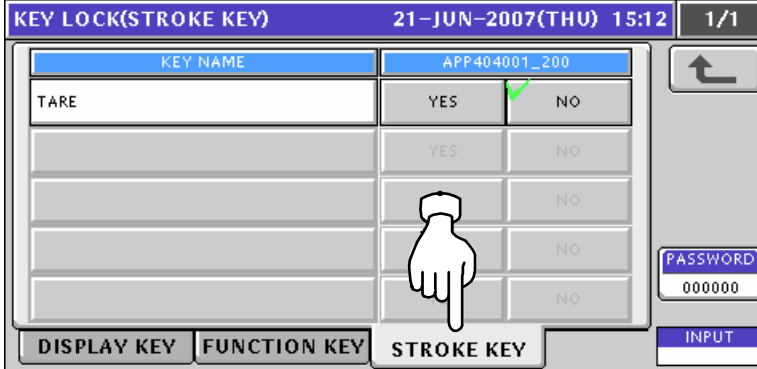

5. Enter a 6-digit password using the numeric keys and press the [PASSWORD] display field on the screen.

EXAMPLE Password "999999"

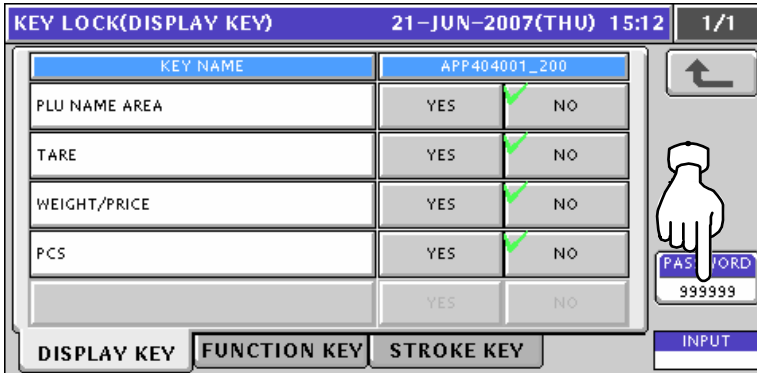

6. Press a desired mode by pressing the corresponding tab, and press to select desired buttons to set whether or not to use the password.

EXAMPLE Set to apply the password to "Multi" in Function Key Mode.

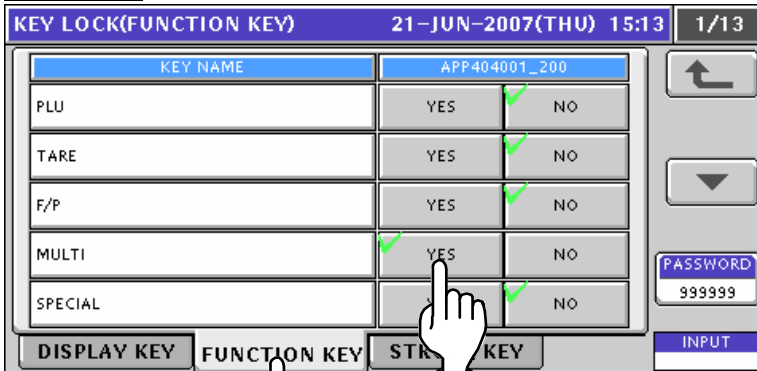

11.6 DATA STORAGE SETTING

1. Press the "Data Storage" field on the Setup Menu Select screen.



2. The Data Storage (Total Add) screen appears. Press the [▼] or [▲] button to change the pages.

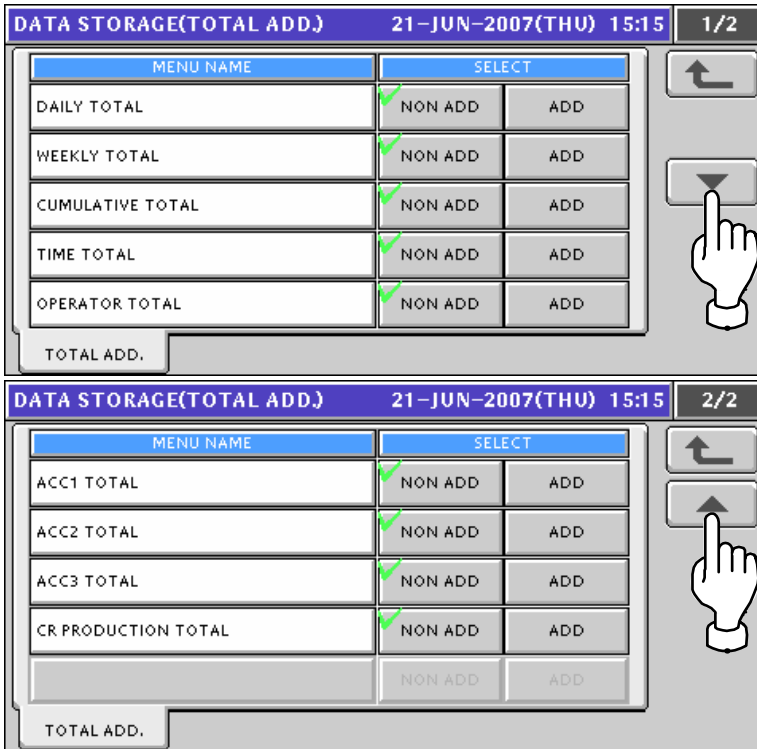

3. Press desired buttons to set whether or not to use the total addition.

EXAMPLE Set to use the operator total addition.

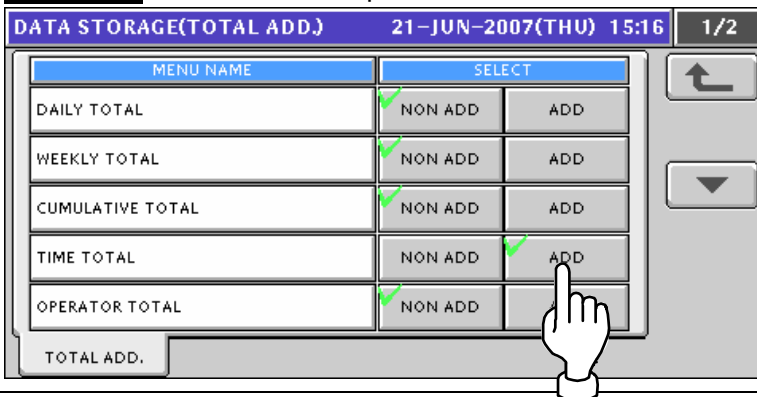

11.7 PRESET REPORT SETTING

1. Press the "Preset Report" field on the Setup Menu Select screen.

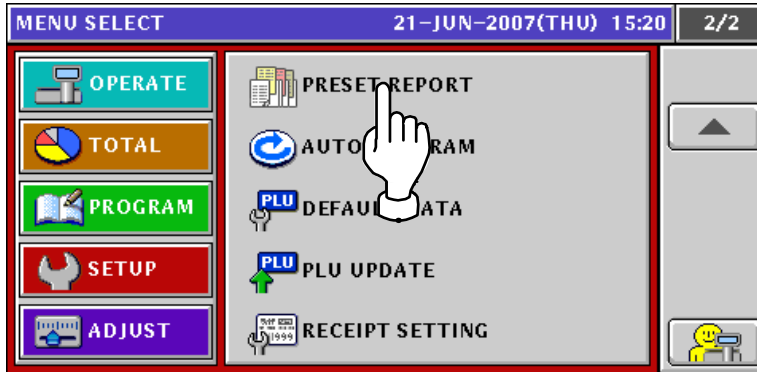

2. The Preset Report (Daily) screen appears.
Press the [▼] or [▲] button to change the pages.

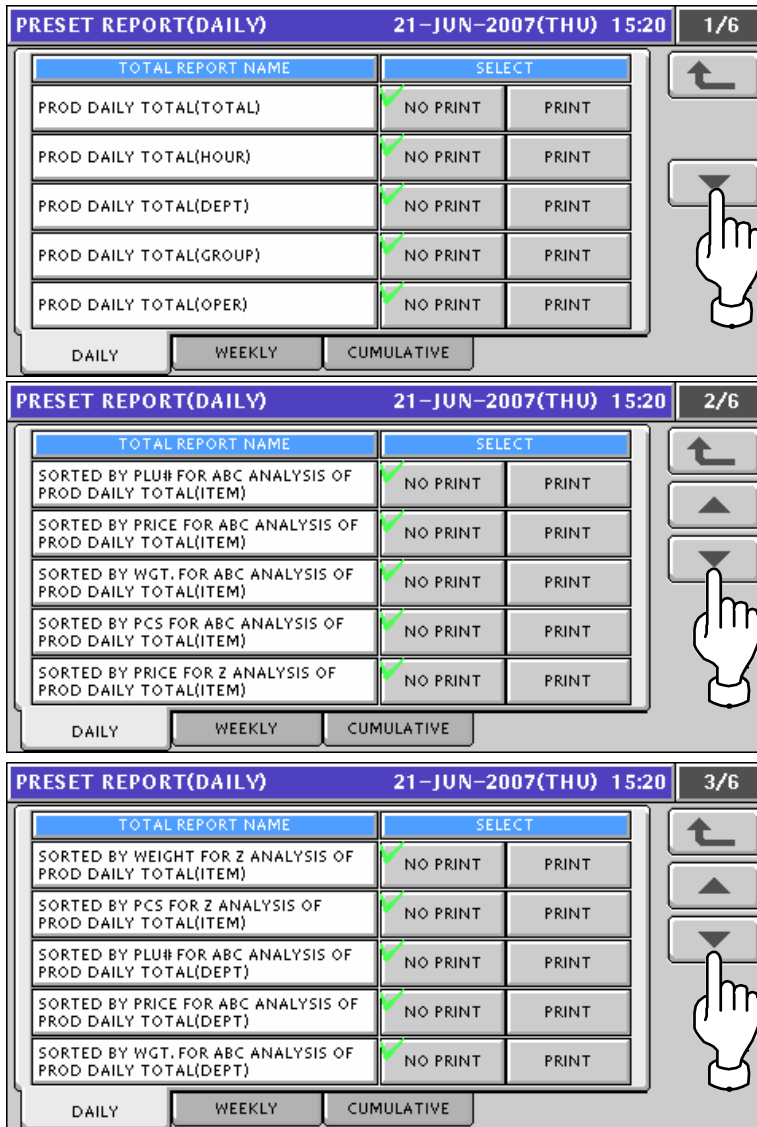

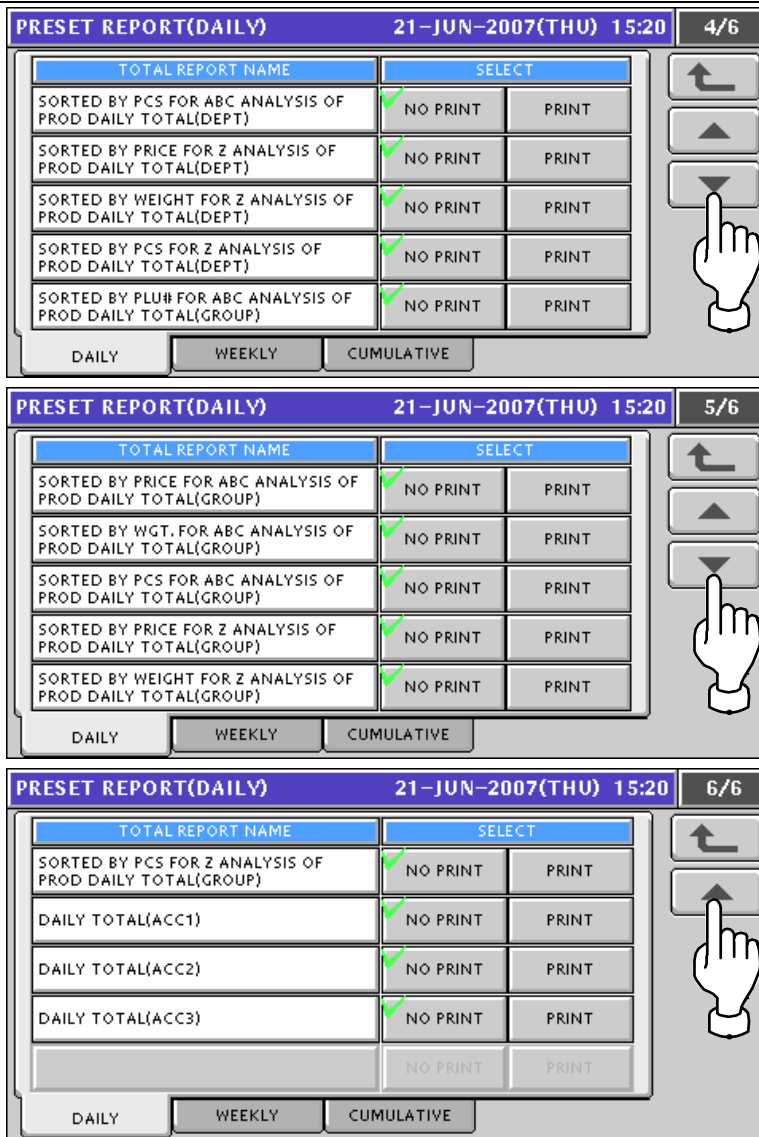

3. Press the [WEEKLY] tab to display the Preset Report (Weekly) screen.

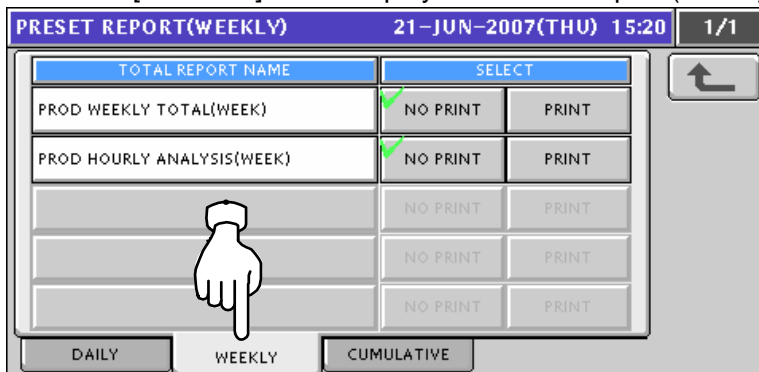

4. Press the [CUMULATIVE] tab to display the Preset Report (Cumulative) screen..
Press the [▼] or [▲] button to change the pages.

PRESET REPORT(CUMULATIVE) 21-JUN-2007(THU) 15:20 1/6

TOTAL REPORT NAME	SELECT	
PROD CUMULATIVE TOTAL(TOTAL)	<input checked="" type="checkbox"/> NO PRINT	<input type="checkbox"/> PRINT
PROD CUMULATIVE TOTAL(HOUR)	<input checked="" type="checkbox"/> NO PRINT	<input type="checkbox"/> PRINT
PROD CUMULATIVE TOTAL(DEPT)	<input checked="" type="checkbox"/> NO PRINT	<input type="checkbox"/> PRINT
PROD CUMULATIVE TOTAL(GROUP)	<input checked="" type="checkbox"/> NO PRINT	<input type="checkbox"/> PRINT
PROD CUMULATIVE TOTAL(OPER)	<input checked="" type="checkbox"/> NO PRINT	<input type="checkbox"/> PRINT

DAILY WEEKLY CUMULATIVE

PRESET REPORT(CUMULATIVE) 21-JUN-2007(THU) 15:20 2/6

TOTAL REPORT NAME	SELECT	
SORTED BY PLU# FOR ABC ANALYSIS OF PROD CUMULATIVE TOTAL(ITEM)	<input checked="" type="checkbox"/> NO PRINT	<input type="checkbox"/> PRINT
SORTED BY PRICE FOR ABC ANALYSIS OF PROD CUMULATIVE TOTAL(ITEM)	<input checked="" type="checkbox"/> NO PRINT	<input type="checkbox"/> PRINT
SORTED BY WGH. FOR ABC ANALYSIS OF PROD CUMULATIVE TOTAL(ITEM)	<input checked="" type="checkbox"/> NO PRINT	<input type="checkbox"/> PRINT
SORTED BY PCS FOR ABC ANALYSIS OF PROD CUMULATIVE TOTAL(ITEM)	<input checked="" type="checkbox"/> NO PRINT	<input type="checkbox"/> PRINT
SORTED BY PRICE FOR Z ANALYSIS OF PROD CUMULATIVE TOTAL(ITEM)	<input checked="" type="checkbox"/> NO PRINT	<input type="checkbox"/> PRINT

DAILY WEEKLY CUMULATIVE

PRESET REPORT(CUMULATIVE) 21-JUN-2007(THU) 15:20 3/6

TOTAL REPORT NAME	SELECT	
SORTED BY WEIGHT FOR Z ANALYSIS OF PROD CUMULATIVE TOTAL(ITEM)	<input checked="" type="checkbox"/> NO PRINT	<input type="checkbox"/> PRINT
SORTED BY PCS FOR Z ANALYSIS OF PROD CUMULATIVE TOTAL(ITEM)	<input checked="" type="checkbox"/> NO PRINT	<input type="checkbox"/> PRINT
SORTED BY PLU# FOR ABC ANALYSIS OF PROD CUMULATIVE TOTAL(DEPT)	<input checked="" type="checkbox"/> NO PRINT	<input type="checkbox"/> PRINT
SORTED BY PRICE FOR ABC ANALYSIS OF PROD CUMULATIVE TOTAL(DEPT)	<input checked="" type="checkbox"/> NO PRINT	<input type="checkbox"/> PRINT
SORTED BY WGT. FOR ABC ANALYSIS OF PROD CUMULATIVE TOTAL(DEPT)	<input checked="" type="checkbox"/> NO PRINT	<input type="checkbox"/> PRINT

DAILY WEEKLY CUMULATIVE

PRESET REPORT(CUMULATIVE) 21-JUN-2007(THU) 15:20 4/6

TOTAL REPORT NAME	SELECT	
SORTED BY PCS FOR ABC ANALYSIS OF PROD CUMULATIVE TOTAL(DEPT)	<input checked="" type="checkbox"/> NO PRINT	<input type="checkbox"/> PRINT
SORTED BY PRICE FOR Z ANALYSIS OF PROD CUMULATIVE TOTAL(DEPT)	<input checked="" type="checkbox"/> NO PRINT	<input type="checkbox"/> PRINT
SORTED BY WEIGHT FOR Z ANALYSIS OF PROD CUMULATIVE TOTAL(DEPT)	<input checked="" type="checkbox"/> NO PRINT	<input type="checkbox"/> PRINT
SORTED BY PCS FOR Z ANALYSIS OF PROD CUMULATIVE TOTAL(DEPT)	<input checked="" type="checkbox"/> NO PRINT	<input type="checkbox"/> PRINT
SORTED BY PLU# FOR ABC ANALYSIS OF PROD CUMULATIVE TOTAL(GROUP)	<input checked="" type="checkbox"/> NO PRINT	<input type="checkbox"/> PRINT

DAILY WEEKLY CUMULATIVE

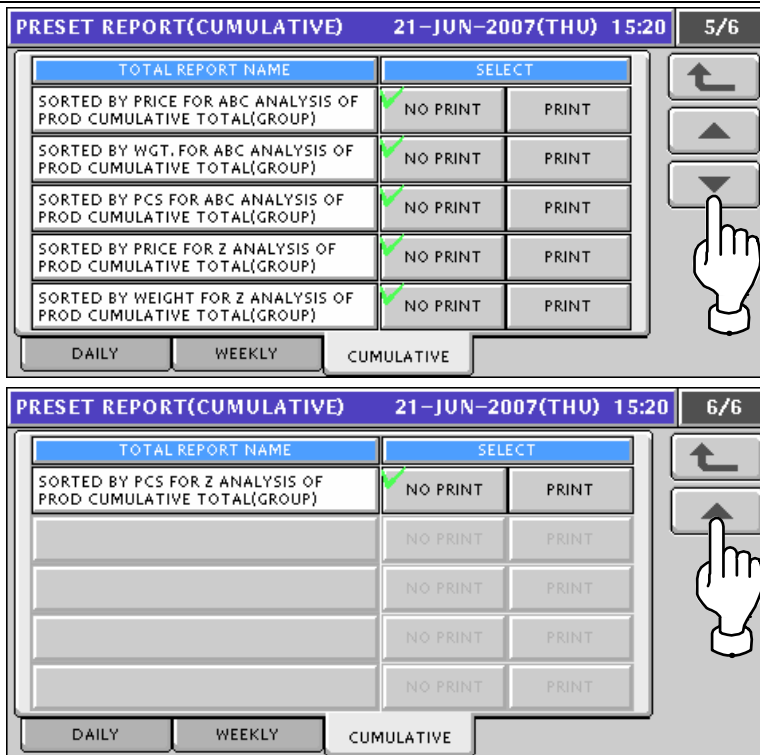

5. Press a desired mode by pressing the corresponding tab, and press to select desired buttons to set whether or not to print the totals

EXAMPLE Set to print the Production Daily Total (Total).

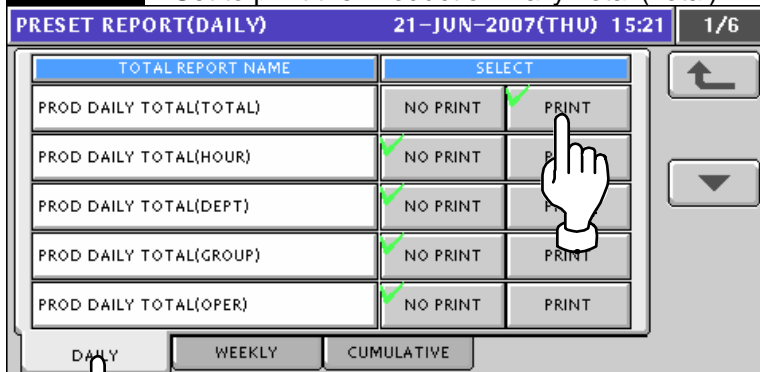

11.8 AUTO PROGRAM SETTING

1. Press the "Auto Program" field on the Setup Menu Select screen.

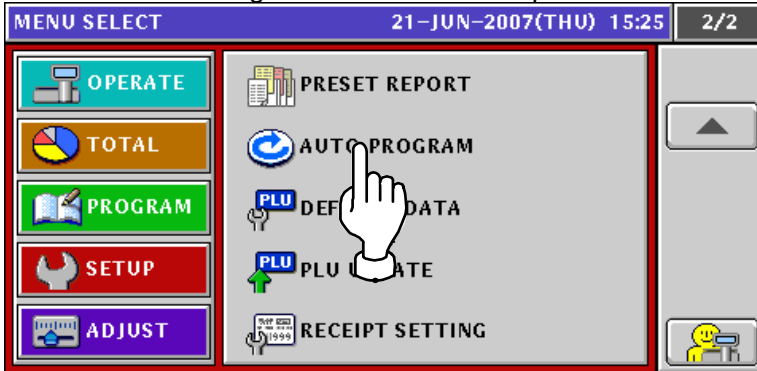

2. The Item Auto Overwrite screen appears. Press the [▼] or [▲] button to change the pages.

Note: Display items may vary depending on the country setting.

ITEM AUTO OVERWRITE		21-JUN-2007(THU) 15:25	1/7
ITEM MASTER LIST	SELECT		
UNIT PRICE:FIX PRICE	YES	<input checked="" type="checkbox"/>	NO
MARKDOWN MODE:M/D AMOUNT	YES	<input checked="" type="checkbox"/>	NO
UNIT TYPE:QTY	YES	<input checked="" type="checkbox"/>	NO
FIXED WEIGHT	YES	<input checked="" type="checkbox"/>	NO
PACK DATE/TIME	YES	<input checked="" type="checkbox"/>	NO
SB DATE/TIME	YES	<input checked="" type="checkbox"/>	NO
2nd LABEL PRINT	YES	<input checked="" type="checkbox"/>	NO

ITEM AUTO OVERWRITE		21-JUN-2007(THU) 15:25	2/7
ITEM MASTER LIST	SELECT		
TARE	YES	<input checked="" type="checkbox"/>	NO
EXTRA MESSAGE1	YES	<input checked="" type="checkbox"/>	NO
EXTRA MESSAGE2	YES	<input checked="" type="checkbox"/>	NO
EXTRA MESSAGE3	YES	<input checked="" type="checkbox"/>	NO
NUTRITION No.	YES	<input checked="" type="checkbox"/>	NO
COUPON MESSAGE	YES	<input checked="" type="checkbox"/>	NO
POP MESSAGE	YES	<input checked="" type="checkbox"/>	NO

ITEM AUTO OVERWRITE		21-JUN-2007(THU) 15:25	3/7
ITEM MASTER LIST	SELECT		
FREE1	YES	<input checked="" type="checkbox"/>	NO
FREE2	YES	<input checked="" type="checkbox"/>	NO
FREE3	YES	<input checked="" type="checkbox"/>	NO
FREE4	YES	<input checked="" type="checkbox"/>	NO
FREE5	YES	<input checked="" type="checkbox"/>	NO
FREE6	YES	<input checked="" type="checkbox"/>	NO
FREE7	YES	<input checked="" type="checkbox"/>	NO

ITEM AUTO OVERWRITE		21-JUN-2007(THU) 15:25		4/7
ITEM MASTER LIST	SELECT			
FREE8	YES	<input checked="" type="checkbox"/>	NO	
FREE9	YES	<input checked="" type="checkbox"/>	NO	
FREE10	YES	<input checked="" type="checkbox"/>	NO	
FREE11	YES	<input checked="" type="checkbox"/>	NO	
FREE12	YES	<input checked="" type="checkbox"/>	NO	
FREE13	YES	<input checked="" type="checkbox"/>	NO	
FREE14	YES	<input checked="" type="checkbox"/>	NO	

ITEM AUTO OVERWRITE		21-JUN-2007(THU) 15:25		5/7
ITEM MASTER LIST	SELECT			
FREE15	YES	<input checked="" type="checkbox"/>	NO	
IMAGE1	YES	<input checked="" type="checkbox"/>	NO	
IMAGE2	YES	<input checked="" type="checkbox"/>	NO	
IMAGE3	YES	<input checked="" type="checkbox"/>	NO	
SH(SAFE HANDLING) IMAGE	YES	<input type="checkbox"/>	NO	
SH IMAGE FLAG	YES	<input type="checkbox"/>	NO	
FIRST LABEL FORMAT No.	YES	<input type="checkbox"/>	NO	

ITEM AUTO OVERWRITE		21-JUN-2007(THU) 15:25		6/7
ITEM MASTER LIST	SELECT			
SECOND LABEL FORMAT No.	YES	<input type="checkbox"/>	NO	
DISPLAY IMAGE	YES	<input type="checkbox"/>	NO	
TARGET	YES	<input checked="" type="checkbox"/>	NO	
SERVICE FEE	YES	<input type="checkbox"/>	NO	
	YES	<input type="checkbox"/>	NO	
	YES	<input type="checkbox"/>	NO	
UB DATE	YES	<input checked="" type="checkbox"/>	NO	

ITEM AUTO OVERWRITE		21-JUN-2007(THU) 15:25		7/7
ITEM MASTER LIST	SELECT			
2nd TARE	YES	<input checked="" type="checkbox"/>	NO	
P. TARE	YES	<input type="checkbox"/>	NO	
F. TARE	YES	<input type="checkbox"/>	NO	
	YES	<input type="checkbox"/>	NO	
	YES	<input type="checkbox"/>	NO	
	YES	<input type="checkbox"/>	NO	
	YES	<input type="checkbox"/>	NO	

3. Press to select desired buttons to set whether or not to overwrite the items automatically.

ITEM AUTO OVERWRITE		21-JUN-2007(THU) 15:26		1/7
ITEM MASTER LIST	SELECT			
UNIT PRICE:FIX PRICE	YES	<input checked="" type="checkbox"/>	NO	
MARKDOWN MODE:M/D AMOUNT	<input checked="" type="checkbox"/>	YES	NO	
UNIT TYPE:QTY		<input checked="" type="checkbox"/>	NO	
FIXED WEIGHT		<input checked="" type="checkbox"/>	NO	
PACK DATE/TIME		<input checked="" type="checkbox"/>	NO	
SB DATE/TIME	YES	<input checked="" type="checkbox"/>	NO	
2nd LABEL PRINT	YES	<input checked="" type="checkbox"/>	NO	

11.9 DEFAULT DATA SETTING

1. Press the "Default Data" field on the Setup Menu Select screen.

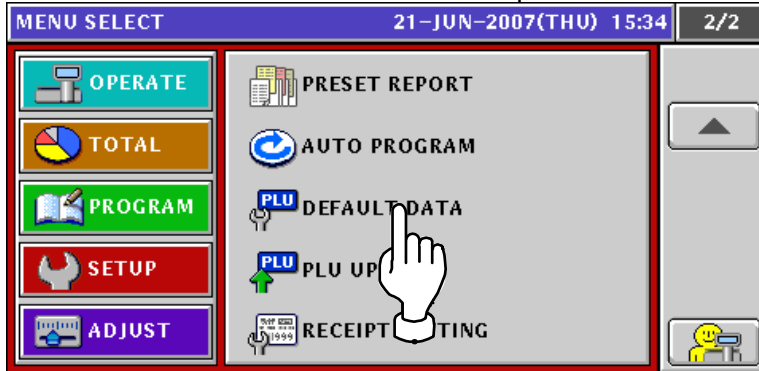

2. The Item Initial Data (Sales 1) screen appears.

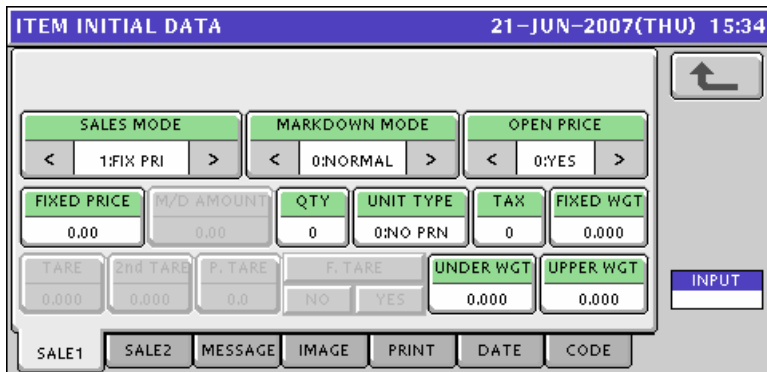
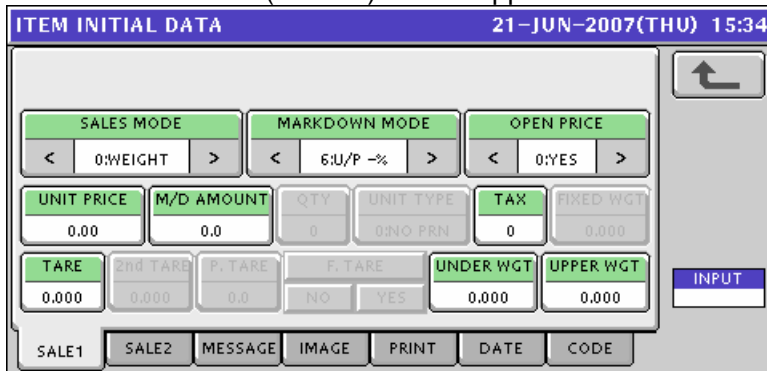

ITEM	DESCRIPTION
SALES MODE	Press the [<] or [>] button to select a desired Sales Mode.
	0: Weighing product
	1: Fixed price product
	2: Weighing fixed price product
MARKDOWN MODE	3: Fixed unit price
	Press the [<] or [>] button to select a desired Markdown Mode.
	1: Special price
	2: Amount discount for total price
	3: Percent discount for total price
	4: Special unit price
5: Amount discount for unit price	
6: Percent discount for unit price	

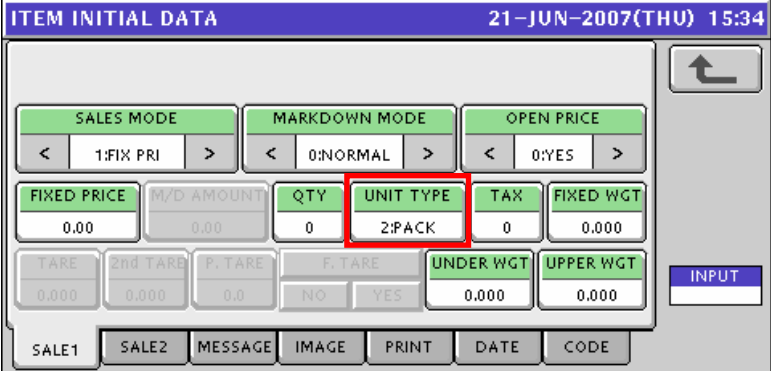
OPEN PRICE	<p>Press the [<] or [>] button to select whether or not to allow open prices system.</p> <p>0: Yes 1: No</p>
UNIT PRICE	Enter a unit price and press this field.
M/D AMOUNT	Enter a markdown amount or percentage and press this field.
QTY	Enter a quantity and press this field.
UNIT TYPE	<p>Press this field to display the Fix Price Mark List screen. Then, select a desired price mark by pressing the corresponding field.</p> <p>EXAMPLE "Pack Packs"</p>  <p>ITEM INITIAL DATA 21-JUN-2007(THU) 15:34</p> 
FIXED PRICE	Enter a fixed price and press this field.
TAX	Enter a tax number and press this field.
FIXED WEIGHT	Enter a fixed weight and press this field.
TARE	Enter a tare weight and press this field.
UNDER WEIGHT	Enter a lower weight limit and press this field.
UPPER WEIGHT	Enter an upper weight limit and press this field.

3. Press the "SALE 2" tab to display the Item Initial Data (Sales 2) screen.

ITEM	DESCRIPTION
POINT FLAG	Press the [<] or [>] button to select whether or not to use a point flag. 0: Off 1: On
POINT TYPE	Press the [<] or [>] button to select a desired point type. 0: Weight 1: Fixed weight
POINTS	Enter a point data and press this field.

4-1 Press the "MESSAGE" tab to display the Item Initial Data (Message) screen.

4-2 Press a desired field to display the corresponding list screen.

EXAMPLE "Extra Message 1"

4-3 Select a desired message by pressing the corresponding field.

4-4 The selected message has been registered.

5-1 Press the "IMAGE" tab to display the Item Initial Data (Image) screen.

5-2 Press to select a desired image field.

5-3 The Image List screen appears. Then, select a desired image by pressing the corresponding field.

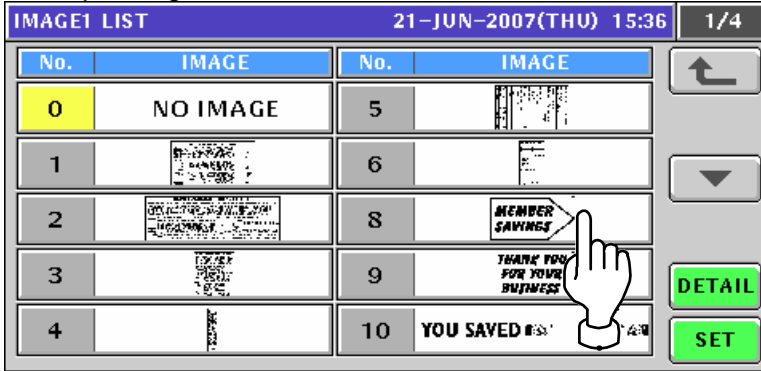

5-4 The selected image has been registered.

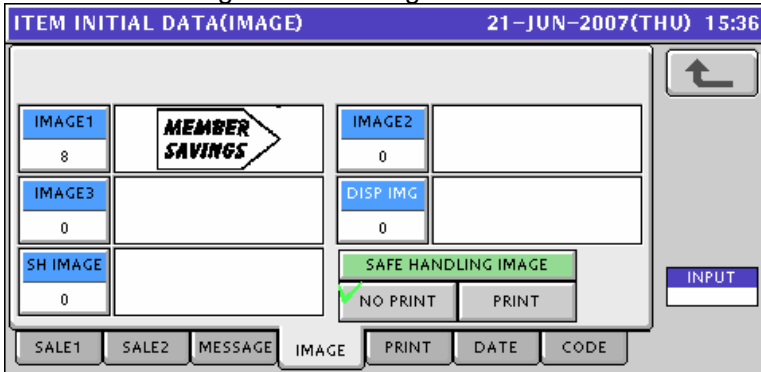

5-5 Press the Display Image field.

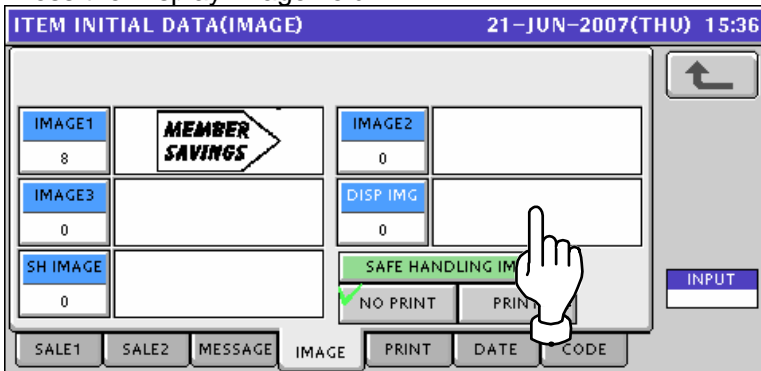

5-6 The Display Image List screen appears. Then, select a desired image by pressing the corresponding field.

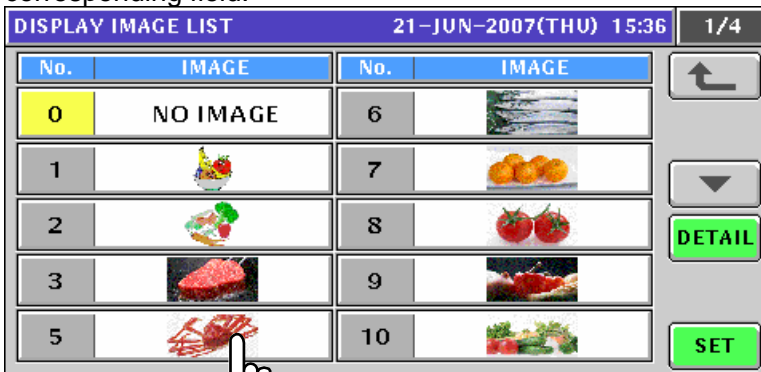

5-7 The selected image has been registered.

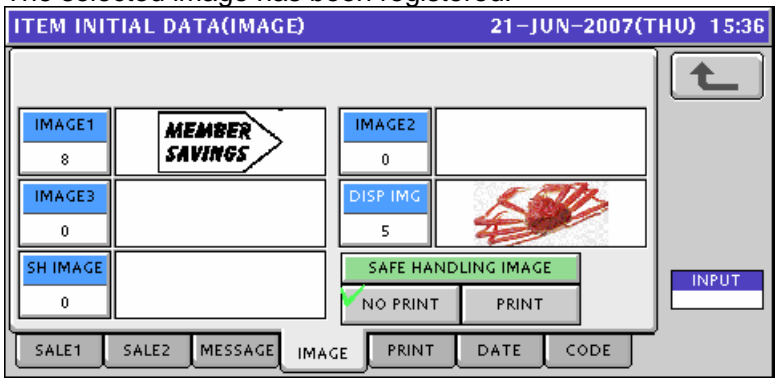

5-8 Select whether or not to print safe handling message.

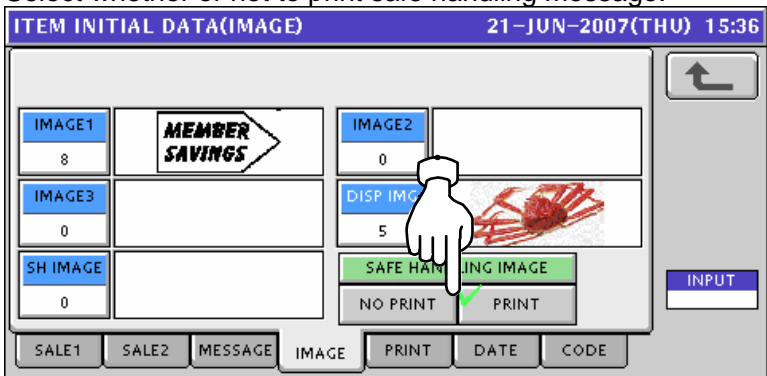

6. Press the "PRINT" tab to display the Item Initial Data (Print) screen.

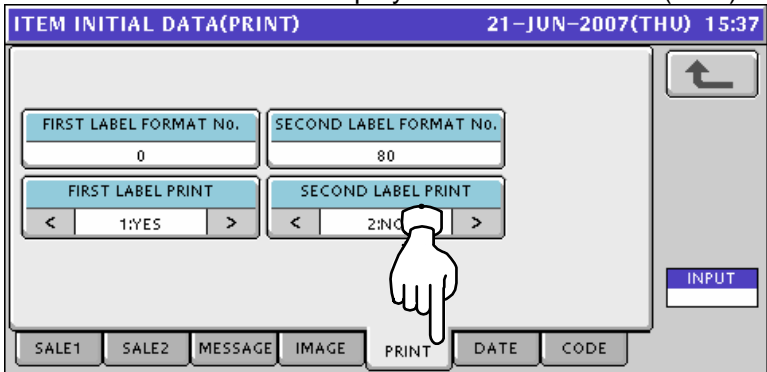

ITEM	DESCRIPTION
FIRST LABEL FORMAT NO.	Enter a desired format number and press this field.
SECOND LABEL FORMAT NO.	Enter a desired format number and press this field.
FIRST LABEL PRINT	Press the [<] or [>] button to select whether or not to print first labels. 1: Yes 2: No
SECOND LABEL PRINT	Press the [<] or [>] button to select whether or not to print first labels. 1: Yes 2: No

7. Press the “DATE” tab to display the Item Initial Data (Date) screen.

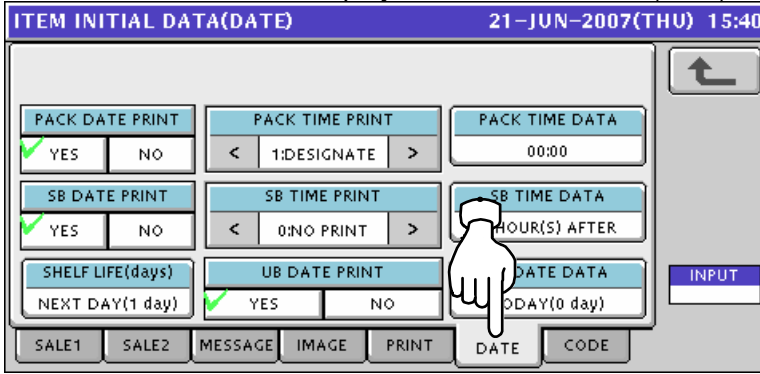

ITEM	DESCRIPTION
PACK DATE PRINT	Press to select whether or not to print pack date.
PACK TIME PRINT	Press the [<] or [>] button to select a desired printing method. 0: No print 1: Designated time 2: System clock time
PACK TIME DATA	Enter a desired pack time and press this field.
SB DATE PRINT	Press to select whether or not to print sell-by date.
SB TIME PRINT	Press the [<] or [>] button to select a desired printing method. 0: No print 1: Designated time 2: Relative time
SB TIME DATA	Enter a number of “Time After” for sell-by time and press this field.
SHELF LIFE (DAYS)	Enter a number of days for shelf life and press this field.
UB DATE PRINT	Press to select whether or not to print use-by date.
UB DATE DATA	Enter a number of days for use-by date and press this field.

8. Press the “DATE” tab to display the Item Initial Data (Date) screen.

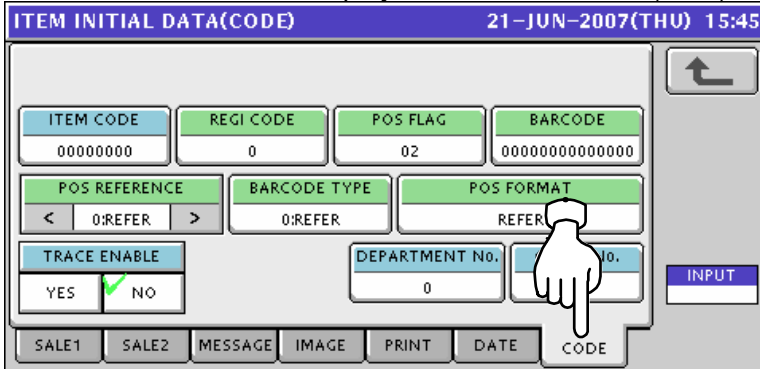

ITEM	DESCRIPTION
ITEM CODE	Enter an item code and press this field.
REGI CODE	Enter a register code and press this field.
POS FLAG	Enter a POS flag number and press this field.
BARCODE	Enter a barcode and press this field.
POS REFERENCE	Press the [<] or [>] button to select a desired reference method. 0: Refer 1: PLU file

<p>BARCODE TYPE</p>	<p>The Barcode Type screen appears when this field is pressed. Press to select a desired type.</p> <table border="1"> <tr> <td colspan="2">BARCODE TYPE</td> <td>21-JUN-2007(THU) 15:45</td> <td>1/1</td> </tr> <tr> <td>00</td> <td>REFER</td> <td>07</td> <td>RSS-14 STO</td> </tr> <tr> <td>01</td> <td>NON PLU 13</td> <td>08</td> <td>RSS-14 LIM</td> </tr> <tr> <td>02</td> <td>NON PLU 8</td> <td>09</td> <td>RSS-14 EXP</td> </tr> <tr> <td>03</td> <td>PLU 13</td> <td>10</td> <td>ITF</td> </tr> <tr> <td>04</td> <td>PLU 8</td> <td>11</td> <td>Not Available</td> </tr> <tr> <td>05</td> <td>RSS-14</td> <td></td> <td></td> </tr> <tr> <td>06</td> <td>RSS-14 ST</td> <td></td> <td></td> </tr> </table>	BARCODE TYPE		21-JUN-2007(THU) 15:45	1/1	00	REFER	07	RSS-14 STO	01	NON PLU 13	08	RSS-14 LIM	02	NON PLU 8	09	RSS-14 EXP	03	PLU 13	10	ITF	04	PLU 8	11	Not Available	05	RSS-14			06	RSS-14 ST																																																																		
BARCODE TYPE		21-JUN-2007(THU) 15:45	1/1																																																																																														
00	REFER	07	RSS-14 STO																																																																																														
01	NON PLU 13	08	RSS-14 LIM																																																																																														
02	NON PLU 8	09	RSS-14 EXP																																																																																														
03	PLU 13	10	ITF																																																																																														
04	PLU 8	11	Not Available																																																																																														
05	RSS-14																																																																																																
06	RSS-14 ST																																																																																																
<p>POS FORMAT</p>	<p>The Barcode Format screen appears when this field is pressed. Press to select a desired format.</p> <table border="1"> <tr> <td colspan="2">BARCODE FORMAT</td> <td>21-JUN-2007(THU) 15:45</td> <td>1/3</td> </tr> <tr> <td>00</td> <td>REFER</td> <td>07</td> <td>FFCCCCCWWWW(C/D)</td> </tr> <tr> <td>01</td> <td>FFCCCC(C/P)PPPP(C/D)</td> <td>08</td> <td>FCCCCCWWWW(C/D)</td> </tr> <tr> <td>02</td> <td>FFCCCCPPPP(C/D)</td> <td>09</td> <td>FCCCCIIIIII(C/D)</td> </tr> <tr> <td>03</td> <td>FCCCC(C/P)PPPP(C/D)</td> <td>0A</td> <td>FFCCCCPPPP(C/D) *</td> </tr> <tr> <td>04</td> <td>FFCCCCPPPP(C/D)</td> <td>0B</td> <td>FFCCCCCWWWW(C/D) *</td> </tr> <tr> <td>05</td> <td>FCCCCPPPP(C/D)</td> <td>0C</td> <td>FFCCC(C/W)WWWW(C/D)</td> </tr> <tr> <td>06</td> <td>FFCCC(C/P)PPPP(C/D)</td> <td>0D</td> <td>Not Available</td> </tr> </table> <table border="1"> <tr> <td colspan="2">BARCODE FORMAT</td> <td>21-JUN-2007(THU) 15:45</td> <td>2/3</td> </tr> <tr> <td>0E</td> <td>Not Available</td> <td>15</td> <td>FFCCCCPPPP(C/D)</td> </tr> <tr> <td>0F</td> <td>FFCCCC(0)PPPP(C/D)</td> <td>16</td> <td>FCCWWWWPPPP(C/D)</td> </tr> <tr> <td>10</td> <td>FFCCCCWWWW(C/D)</td> <td>17</td> <td>FFCCCCQPPPP(C/D)</td> </tr> <tr> <td>11</td> <td>FFCCCCPPPP(/10)(C/D)</td> <td>18</td> <td>FIIIIIPPPP(C/D)</td> </tr> <tr> <td>12</td> <td>FFCCCC(C/P)PPPP(/10)(C/D)</td> <td>19</td> <td>FFIIIIIIPPPP(C/D)</td> </tr> <tr> <td>13</td> <td>FFCCCC(C/W)WWWW(C/D)</td> <td>1A</td> <td>FCCCPPPPPP(C/D)</td> </tr> <tr> <td>14</td> <td>FCCCCPPPP(C/D)</td> <td>1B</td> <td>FIIIIIPPPP(/10)(C/D)</td> </tr> </table> <table border="1"> <tr> <td colspan="2">BARCODE FORMAT</td> <td>21-JUN-2007(THU) 15:45</td> <td>3/3</td> </tr> <tr> <td>1C</td> <td>FFIIIIIIPPPP(/10)(C/D)</td> <td></td> <td></td> </tr> <tr> <td>1D</td> <td>FCCCCPPPP(/10)(C/D)</td> <td></td> <td></td> </tr> <tr> <td>1E</td> <td>FFCCCCPPPP(/10)(C/D)</td> <td></td> <td></td> </tr> <tr> <td>1F</td> <td>FFCCCCQQQQ(C/D)</td> <td></td> <td></td> </tr> <tr> <td></td> <td></td> <td></td> <td></td> </tr> <tr> <td></td> <td></td> <td></td> <td></td> </tr> <tr> <td></td> <td></td> <td></td> <td></td> </tr> </table>	BARCODE FORMAT		21-JUN-2007(THU) 15:45	1/3	00	REFER	07	FFCCCCCWWWW(C/D)	01	FFCCCC(C/P)PPPP(C/D)	08	FCCCCCWWWW(C/D)	02	FFCCCCPPPP(C/D)	09	FCCCCIIIIII(C/D)	03	FCCCC(C/P)PPPP(C/D)	0A	FFCCCCPPPP(C/D) *	04	FFCCCCPPPP(C/D)	0B	FFCCCCCWWWW(C/D) *	05	FCCCCPPPP(C/D)	0C	FFCCC(C/W)WWWW(C/D)	06	FFCCC(C/P)PPPP(C/D)	0D	Not Available	BARCODE FORMAT		21-JUN-2007(THU) 15:45	2/3	0E	Not Available	15	FFCCCCPPPP(C/D)	0F	FFCCCC(0)PPPP(C/D)	16	FCCWWWWPPPP(C/D)	10	FFCCCCWWWW(C/D)	17	FFCCCCQPPPP(C/D)	11	FFCCCCPPPP(/10)(C/D)	18	FIIIIIPPPP(C/D)	12	FFCCCC(C/P)PPPP(/10)(C/D)	19	FFIIIIIIPPPP(C/D)	13	FFCCCC(C/W)WWWW(C/D)	1A	FCCCPPPPPP(C/D)	14	FCCCCPPPP(C/D)	1B	FIIIIIPPPP(/10)(C/D)	BARCODE FORMAT		21-JUN-2007(THU) 15:45	3/3	1C	FFIIIIIIPPPP(/10)(C/D)			1D	FCCCCPPPP(/10)(C/D)			1E	FFCCCCPPPP(/10)(C/D)			1F	FFCCCCQQQQ(C/D)														
BARCODE FORMAT		21-JUN-2007(THU) 15:45	1/3																																																																																														
00	REFER	07	FFCCCCCWWWW(C/D)																																																																																														
01	FFCCCC(C/P)PPPP(C/D)	08	FCCCCCWWWW(C/D)																																																																																														
02	FFCCCCPPPP(C/D)	09	FCCCCIIIIII(C/D)																																																																																														
03	FCCCC(C/P)PPPP(C/D)	0A	FFCCCCPPPP(C/D) *																																																																																														
04	FFCCCCPPPP(C/D)	0B	FFCCCCCWWWW(C/D) *																																																																																														
05	FCCCCPPPP(C/D)	0C	FFCCC(C/W)WWWW(C/D)																																																																																														
06	FFCCC(C/P)PPPP(C/D)	0D	Not Available																																																																																														
BARCODE FORMAT		21-JUN-2007(THU) 15:45	2/3																																																																																														
0E	Not Available	15	FFCCCCPPPP(C/D)																																																																																														
0F	FFCCCC(0)PPPP(C/D)	16	FCCWWWWPPPP(C/D)																																																																																														
10	FFCCCCWWWW(C/D)	17	FFCCCCQPPPP(C/D)																																																																																														
11	FFCCCCPPPP(/10)(C/D)	18	FIIIIIPPPP(C/D)																																																																																														
12	FFCCCC(C/P)PPPP(/10)(C/D)	19	FFIIIIIIPPPP(C/D)																																																																																														
13	FFCCCC(C/W)WWWW(C/D)	1A	FCCCPPPPPP(C/D)																																																																																														
14	FCCCCPPPP(C/D)	1B	FIIIIIPPPP(/10)(C/D)																																																																																														
BARCODE FORMAT		21-JUN-2007(THU) 15:45	3/3																																																																																														
1C	FFIIIIIIPPPP(/10)(C/D)																																																																																																
1D	FCCCCPPPP(/10)(C/D)																																																																																																
1E	FFCCCCPPPP(/10)(C/D)																																																																																																
1F	FFCCCCQQQQ(C/D)																																																																																																
<p>TRACE ENABLE</p>	<p>Press to select whether or not to enable traceability function.</p>																																																																																																
<p>DEPARTMENT NO.</p>	<p>Enter a department number and press this field.</p>																																																																																																
<p>GROUP NO.</p>	<p>Enter a group number and press this field.</p>																																																																																																

11.10 PLU UPDATE SETTING

1. Press the "PLU Update" field on the Setup Menu Select screen.

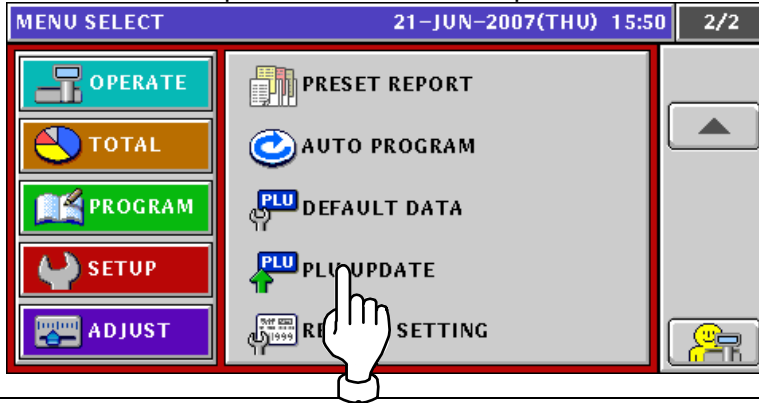

2. The PLU Update screen appears.
Press the [▼] or [▲] button to change the pages.

Note: Display items may vary depending on the country setting.

The three screenshots show the 'PLU UPDATE' screen at different stages of navigation. Each screen has a header bar with '21-JUN-2007(THU) 15:50' and a page indicator (1/14, 2/14, 3/14). The screen is divided into several sections: 'START No.' (1), 'END No.' (99999999), and 'CONDITION' (NO/YES). Below this is a table with columns 'No.', 'LIST NAME', 'REPLACE CONDITION', and 'CHANGE CONTENTS'. An 'EXECUTE' button is at the bottom right of each screen. A hand cursor is shown pointing at the navigation buttons (up/down arrows) on the right side of each screen.

No.	LIST NAME	REPLACE CONDITION	CHANGE CONTENTS
1	ITEM CODE		
2	PACK DATE PRINT		
3	PACK TIME PRINT		
4	PACK TIME DATA		
5	SB DATE PRINT		
6	SB TIME PRINT		
7	SHELF LIFE(days)		
8	SB TIME DATA		
9	UB DATE PRINT		
10	UB DATE DATA		
11	NUTRITION No.		
12	F. TARE		
13	SAFE HANDLING IMAGE		
14	SH IMAGE		
15	POINT FLAG		

PLU UPDATE 21-JUN-2007(THU) 15:50 4/14

START No. 1 END No. 99999999 CONDITION NO YES

No.	LIST NAME	REPLACE CONDITION	CHANGE CONTENTS
16	POINT TYPE		
17	POINTS		
18	FIRST LABEL PRINT		
19	SECOND LABEL PRINT		
20	1st LABEL FORAMT No.		

INPUT EXECUTE

PLU UPDATE 21-JUN-2007(THU) 15:50 5/14

START No. 1 END No. 99999999 CONDITION NO YES

No.	LIST NAME	REPLACE CONDITION	CHANGE CONTENTS
21	2nd LABEL FORAMT No.		
22	COOKING INSTRUCTION		
23	FREE1		
24	FREE2		
25	FREE3		

INPUT EXECUTE

PLU UPDATE 21-JUN-2007(THU) 15:50 6/14

START No. 1 END No. 99999999 CONDITION NO YES

No.	LIST NAME	REPLACE CONDITION	CHANGE CONTENTS
26	FREE4		
27	FREE5		
28	FREE6		
29	FREE7		
30	FREE8		

INPUT EXECUTE

PLU UPDATE 21-JUN-2007(THU) 15:50 7/14

START No. 1 END No. 99999999 CONDITION NO YES

No.	LIST NAME	REPLACE CONDITION	CHANGE CONTENTS
31	FREE9		
32	FREE10		
33	FREE11		
34	FREE12		
35	FREE13		

INPUT EXECUTE

PLU UPDATE 21-JUN-2007(THU) 15:51 8/14

START No. 1 END No. 99999999 CONDITION NO YES

No.	LIST NAME	REPLACE CONDITION	CHANGE CONTENTS
36	FREE14		
37	FREE15		
38	DISPLAY IMAGE		
39	OPEN PRICE		
40	TRACE ENABLE		

INPUT EXECUTE

PLU UPDATE				21-JUN-2007(THU) 15:51	9/14
START No.	END No.	CONDITION			
1	99999999	<input checked="" type="checkbox"/> NO	<input type="checkbox"/> YES		
No.	LIST NAME	REPLACE CONDITION	CHANGE CONTENTS		
41	TRACE SCHEME No.				
42	REGI CODE				
43	SALES MODE				
44	UNIT PRICE				
45	FIX PRICE				
				INPUT	EXECUTE

PLU UPDATE				21-JUN-2007(THU) 15:51	10/14
START No.	END No.	CONDITION			
1	99999999	<input checked="" type="checkbox"/> NO	<input type="checkbox"/> YES		
No.	LIST NAME	REPLACE CONDITION	CHANGE CONTENTS		
46	MARKDOWN MODE				
47	M/D AMOUNT				
48	FIXED WEIGHT				
49	QTY				
50	UNIT TYPE				
				INPUT	EXECUTE

PLU UPDATE				21-JUN-2007(THU) 15:51	11/14
START No.	END No.	CONDITION			
1	99999999	<input checked="" type="checkbox"/> NO	<input type="checkbox"/> YES		
No.	LIST NAME	REPLACE CONDITION	CHANGE CONTENTS		
51	UPPER WGT				
52	UNDER WGT				
53	TARE				
54	2nd TARE				
55	P. TARE				
				INPUT	EXECUTE

PLU UPDATE				21-JUN-2007(THU) 15:51	12/14
START No.	END No.	CONDITION			
1	99999999	<input checked="" type="checkbox"/> NO	<input type="checkbox"/> YES		
No.	LIST NAME	REPLACE CONDITION	CHANGE CONTENTS		
56	BARCODE TYPE				
57	POS REFERENCE				
58	POS FLAG				
59	BARCODE				
60	POS FORMAT				
				INPUT	EXECUTE

PLU UPDATE				21-JUN-2007(THU) 15:51	13/14
START No.	END No.	CONDITION			
1	99999999	<input checked="" type="checkbox"/> NO	<input type="checkbox"/> YES		
No.	LIST NAME	REPLACE CONDITION	CHANGE CONTENTS		
61	EXTRA MESSAGE1				
62	EXTRA MESSAGE2				
63	EXTRA MESSAGE3				
64	POP MESSAGE				
65	COUPON MESSAGE				
				INPUT	EXECUTE

PLU UPDATE 21-JUN-2007(THU) 15:51 14/14

START No. 1 END No. 99999999 CONDITION NO YES

No.	LIST NAME	REPLACE CONDITION	CHANGE CONTENTS
66	IMAGE1		
67	IMAGE2		
68	IMAGE3		

INPUT EXECUTE

3. Enter the start and end numbers and press these fields to specify the target PLUs.

PLU UPDATE 21-JUN-2007(THU) 15:51 1/14

START No. 100 END No. 99999999 CONDITION NO YES

No.	LIST NAME	REPLACE CONDITION	CHANGE CONTENTS
1	ITEM CODE		
2	PACK DATE PRINT		
3	PACK TIME PRINT		
4	PACK TIME DATA		
5	SB DATE PRINT		

INPUT EXECUTE

4. Select desired items by pressing the corresponding fields.

PLU UPDATE 21-JUN-2007(THU) 15:52 1/14

START No. 100 END No. 9999 CONDITION NO YES

No.	LIST NAME	REPLACE CONDITION	CHANGE CONTENTS
1	ITEM CODE	0	0
2	PACK DATE PRINT		
3	PACK TIME PRINT	2:CLOCK	2:CLOCK
4	PACK TIME DATA		
5	SB DATE PRINT	1:YES	1:YES

INPUT EXECUTE

PLU UPDATE 21-JUN-2007(THU) 15:52 2/14

START No. 100 END No. 9999 CONDITION NO YES

No.	LIST NAME	REPLACE CONDITION	CHANGE CONTENTS
6	SB TIME PRINT	2:RELATIVE	2:RELATIVE
7	SHELF LIFE(days)	THE DAY(1Day)	THE DAY(1Day)
8	SB TIME DATA	0 HOUR(s) AFTER	0 HOUR(s) AFTER
9	UB DATE PRINT	1:YES	1:YES
10	UB DATE DATA	THE DAY(0Day)	THE DAY(0Day)

INPUT EXECUTE

5. To release the selection, press the selected field again.

PLU UPDATE 21-JUN-2007(THU) 15:52 1/14

START No. 100 END No. 9999

CONDITION NO YES

No.	LIST NAME	REPLACE CONDITION	CHANGE CONTENTS
1	ITEM CODE	0	0
2	PACK DATE PRINT		
3	PACK TIME PRINT	2:CLOCK	2:CLOCK
4	PACK TIME DATA		
5	SB DATE PRINT	1:YES	1:YES

INPUT

EXECUTE

BATCH DELETE

PLU UPDATE 21-JUN-2007(THU) 15:52 1/14

START No. 100 END No. 9999

CONDITION NO YES

No.	LIST NAME	REPLACE CONDITION	CHANGE CONTENTS
1	ITEM CODE	0	0
2	PACK DATE PRINT		
3	PACK TIME PRINT	2:CLOCK	2:CLOCK
4	PACK TIME DATA		
5	SB DATE PRINT	1:YES	1:YES

INPUT

EXECUTE

BATCH DELETE



To release all the selections, press the [BATCH DELETE] button.

PLU UPDATE 21-JUN-2007(THU) 15:52 1/14

START No. 100 END No. 9999

CONDITION NO YES

No.	LIST NAME	REPLACE CONDITION	CHANGE CONTENTS
1	ITEM CODE	0	0
2	PACK DATE PRINT		
3	PACK TIME PRINT	2:CLOCK	2:CLOCK
4	PACK TIME DATA		
5	SB DATE PRINT	1:YES	1:YES

INPUT

EXECUTE

BATCH DELETE

PLU UPDATE 21-JUN-2007(THU) 15:52 1/14

START No. 100 END No. 9999

CONDITION NO YES

No.	LIST NAME	REPLACE CONDITION	CHANGE CONTENTS
1	ITEM CODE	0	0
2	PACK DATE PRINT		
3	PACK TIME PRINT	2:CLOCK	2:CLOCK
4	PACK TIME DATA		
5	SB DATE PRINT	1:YES	1:YES

INPUT

EXECUTE

BATCH DELETE



6. Press the [EXECUTE] button to update the selected items.

PLU UPDATE 21-JUN-2007(THU) 15:52 2/14

START No. 100 END No. 9999

CONDITION NO YES

No.	LIST NAME	REPLACE CONDITION	CHANGE CONTENTS
6	SB TIME PRINT	2:RELATIVE	2:RELATIVE
7	SHELF LIFE(days)	THE DAY(1Day)	THE DAY(1Day)
8	SB TIME DATA	0 HOUR(s) AFTER	0 HOUR(s) AFTER
9	UB DATE PRINT	1:YES	1:YES
10	UB DATE DATA	THE DAY(0Day)	THE DAY(0Day)

EXECUTE

INPUT

7. Press the [EXEC] button for execution.

PLU UPDATE 21-JUN-2007(THU) 15:52 2/14

21-JUN-2007(THU) 15:52

ALL REUPDATE CHECK

IT IS OK TO RENEW ALL DATA FOR PRODUCT?

14003 - 0000

EXEC STOP

11.11 RECEIPT SETTING

1. Press the “PLU Update” field on the Setup Menu Select screen.

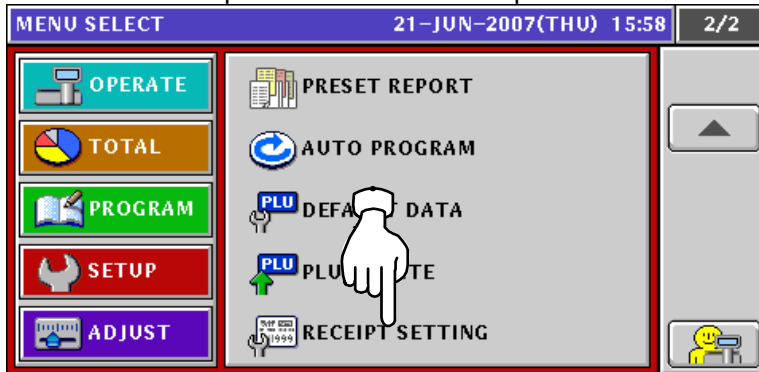

2. The Receipt Setting screen appears. To edit the header and footer titles, press the corresponding field.



3. The Receipt Title Edit screen appears.



4. Edit the text according to the procedure explained in Appendix “Text Editing”.



5. The edited text has been registered.



6. To edit the header and footer logo images, press the corresponding field.

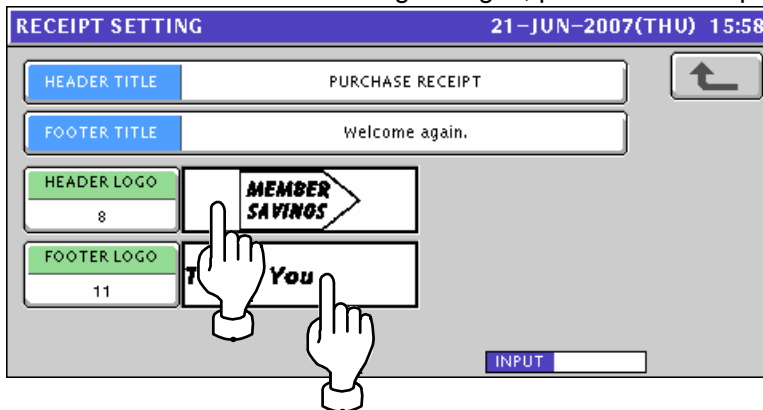

7. The Image List screen appears.

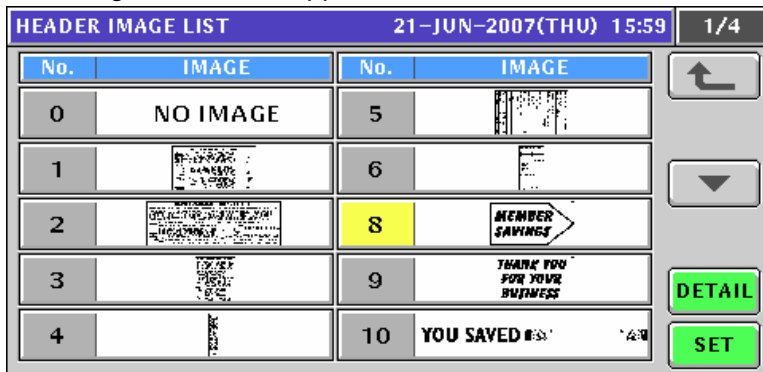

8. Select a desired image by pressing the corresponding field, and press the [SET] button.

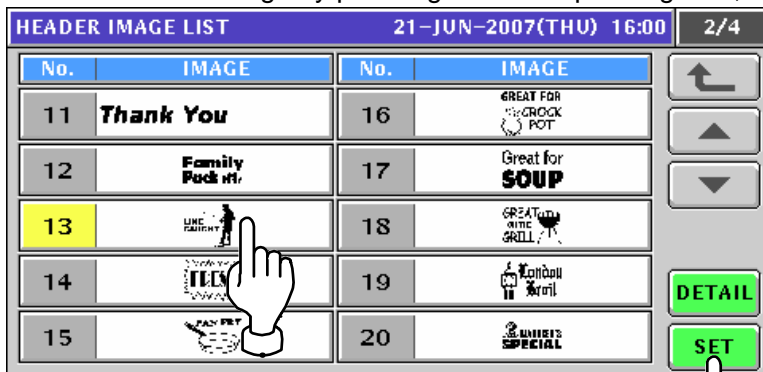

9. The edited logo image has been registered.

RECEIPT SETTING		21-JUN-2007(THU) 16:00
HEADER TITLE	PURCHASE RECEIPT	
FOOTER TITLE	HAVE A GOOD DAY!	
HEADER LOGO 13		
FOOTER LOGO 11	Thank You	
		INPUT <input type="text"/>

ADJUSTMENT MODE

12.1 ADJUSTMENT MODE ENTRY

1. Make sure that the initial screen is displayed.

PLU 0					21-JUN-2007(THU) 16:31		TARE	kg	0.000	
Check the weight before operation. Enter PLU No. and press [PLU] key.								ZERO	WEIGHT kg	0.000
							UNIT PRICE	£/kg	0.00	
GROUND BEEF (TEXAS)	GROUND BEEF (OREGON)	GROUND BEEF (UTAH)	SLICED BEEF	SLICED BEEF SPECIAL			TOTAL PRICE	£	0.00	
ROAST BEEF	ROAST BEEF SPECIAL	LAMB CHOPS	LAMB CHOPS SPECIAL	T-BONE STEAK						
OPERATOR GROUP	PRN MD. <AUTO>	CASSETTE 1	SUBTOTAL DISPLAY							

2. Press the [MODE] key on the key sheet.

Mode

The Operation Mode screen appears. Then, press the [ADJUST] button on the screen

MENU SELECT		21-JUN-2007(THU) 16:31		1/1
	OPERATE		SALES	
	TOTAL		ACC1	
	PROGRAM		ACC2	
	SETUP		ACC3	
	ADJUST		TOTAL ADJUST	

3. The Adjustment Menu Select screen appears.

MENU SELECT		21-JUN-2007(THU) 16:31		1/1
	OPERATE		TIME / DATE SET	
	TOTAL		TOUCH PANEL	
	PROGRAM		DISPLAY CHECK	
	SETUP			
	ADJUST			

12.2 DATE / TIME ADJUSTMENT

1. Press the "TIME / DATE SET" field on the Adjustment Menu Select screen.

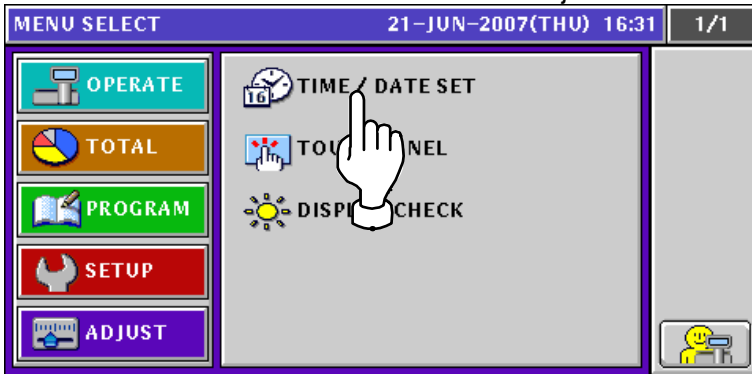

2. The Time/Date Set screen appears.

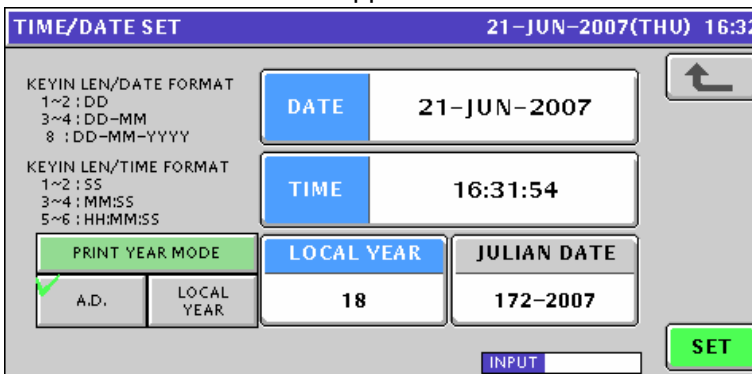

3. To change the date, enter a new date and press the "DATE" field.

EXAMPLE 22 June, 2007

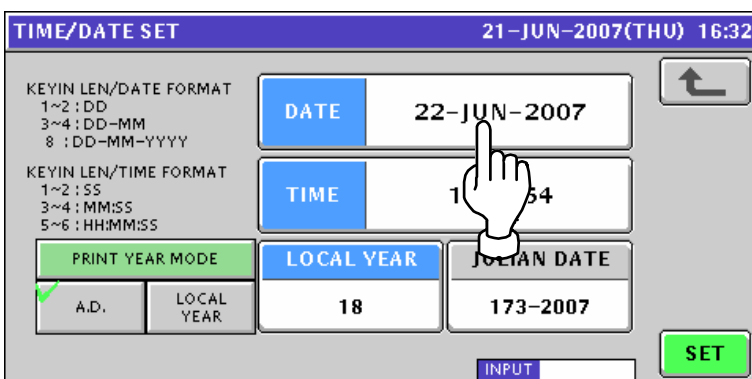
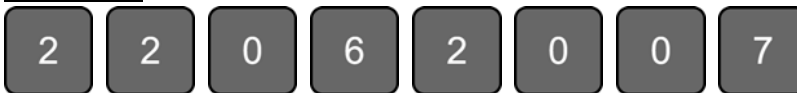

4. To change the time, enter a new time and press the “TIME” field.

EXAMPLE 13:50:00



TIME/DATE SET 21-JUN-2007(THU) 16:32

KEYIN LEN/DATE FORMAT
1~2 : DD
3~4 : DD-MM
8 : DD-MM-YYYY

KEYIN LEN/TIME FORMAT
1~2 : SS
3~4 : MM:SS
5~6 : HH:MM:SS

PRINT YEAR MODE
A.D. LOCAL YEAR

DATE 22-JUN-2007

TIME 13:50:00

LOCAL YEAR 18 JULIAN DATE 173-2007

INPUT SET

5. To register new date and time, press the [SET] button.

TIME/DATE SET 21-JUN-2007(THU) 16:32

KEYIN LEN/DATE FORMAT
1~2 : DD
3~4 : DD-MM
8 : DD-MM-YYYY

KEYIN LEN/TIME FORMAT
1~2 : SS
3~4 : MM:SS
5~6 : HH:MM:SS

PRINT YEAR MODE
A.D. LOCAL YEAR

DATE 22-JUN-2007

TIME 13:50:00

LOCAL YEAR 18 JULIAN DATE 173-2007

INPUT SET

6. The confirmation screen appears. Then, press the [EXEC] button for execution.

TIME/DATE SET 21-JUN-2007(THU) 16:32
21-JUN-2007(THU) 16:32

CHECKING CLOCK SETTING

IF YOU CHANGE TO PROGRAMED
DATE AND TIME [22-JUN-2007/13:50:00]
PRESS [EXEC].

1801 - 0000

EXEC STOP

12.3 TOUCH PANEL ADJUSTMENT

1. Press the "TOUCH PANEL" field on the Adjustment Menu Select screen.

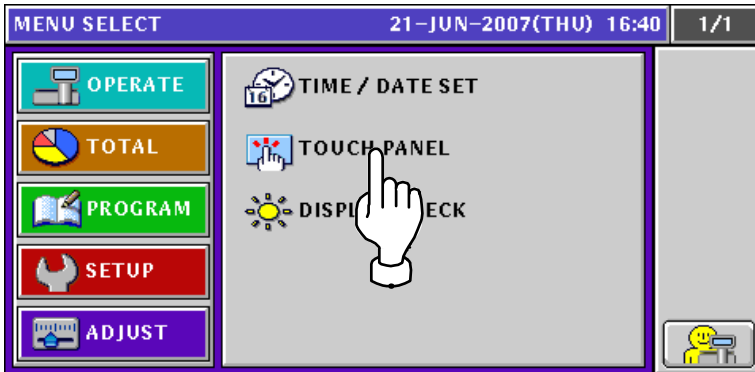

2. The Touch Panel screen appears.

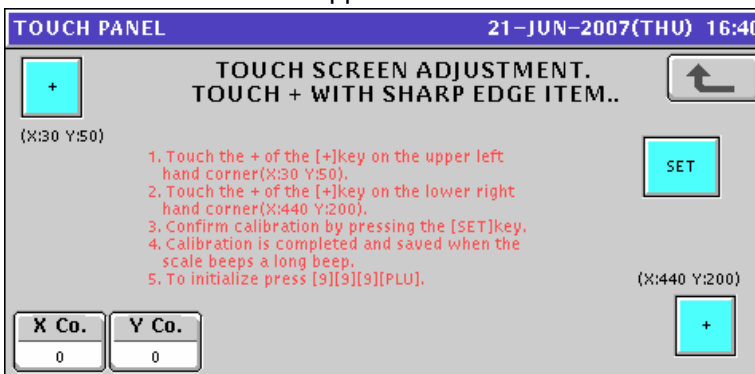

3. Press the [+] button on the upper left of the screen.

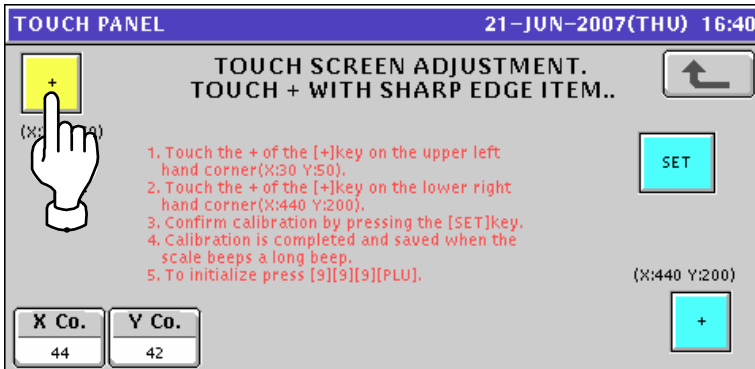

4. Press the [+] button on the lower right of the screen.

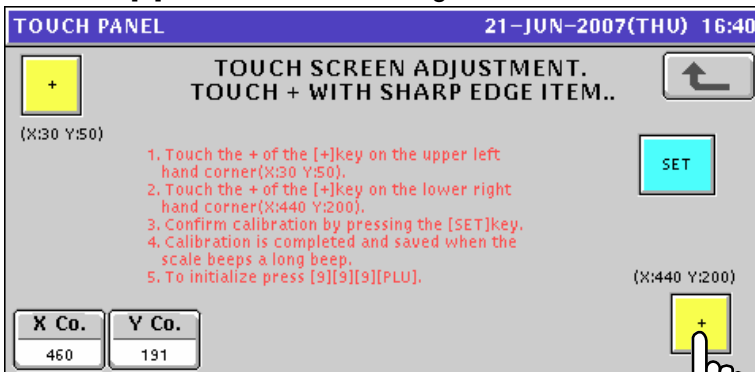

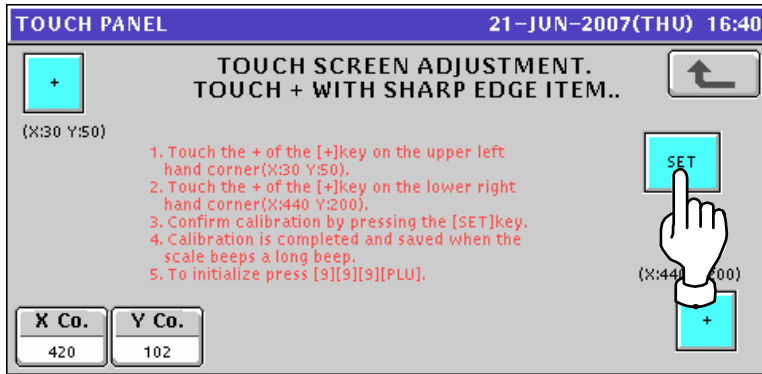
5. Press the [SET] button to confirm calibration.

12.4 DISPLAY CHECK

1. Press the "DISPLAY CHECK" field on the Adjustment Menu Select screen.

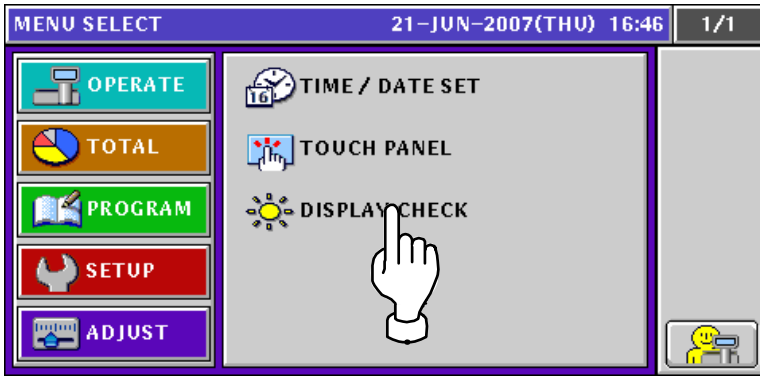

2. The Display Check (Vertical) screen appears. Press the [-] or [+] button to adjust vertical brightnesses for the operator and customer displays.

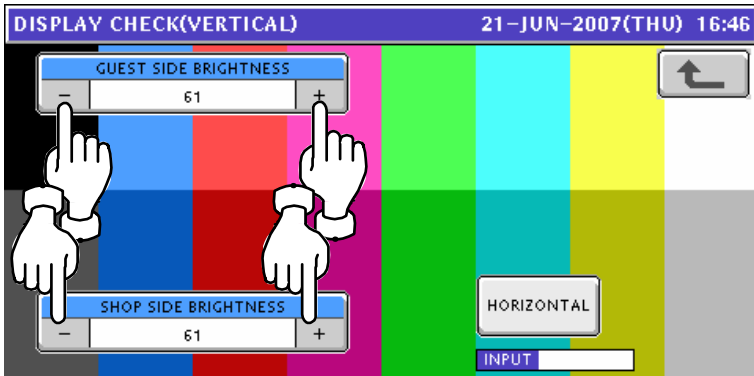

3. Press the [HORIZONTAL] button to change to the horizontal display check screen.

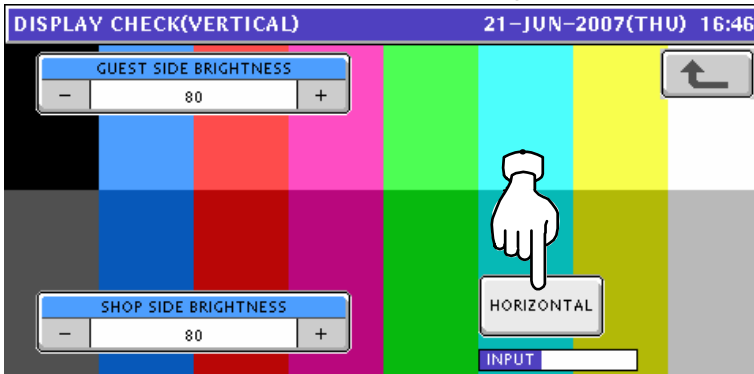

4. The Display Check (Horizontal) screen appears. Press the [-] or [+] button to adjust vertical brightnesses for the operator and customer displays.

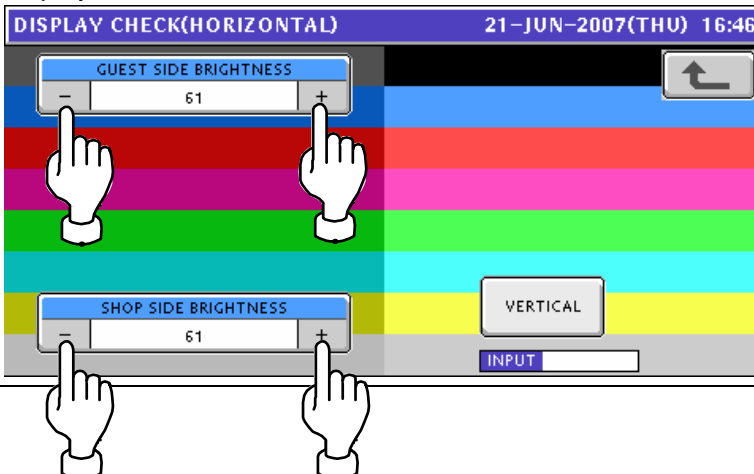

TEXT EDITING

A.1 OPERATION PANEL AND KEY FUNCTIONS

■ Operation Panel

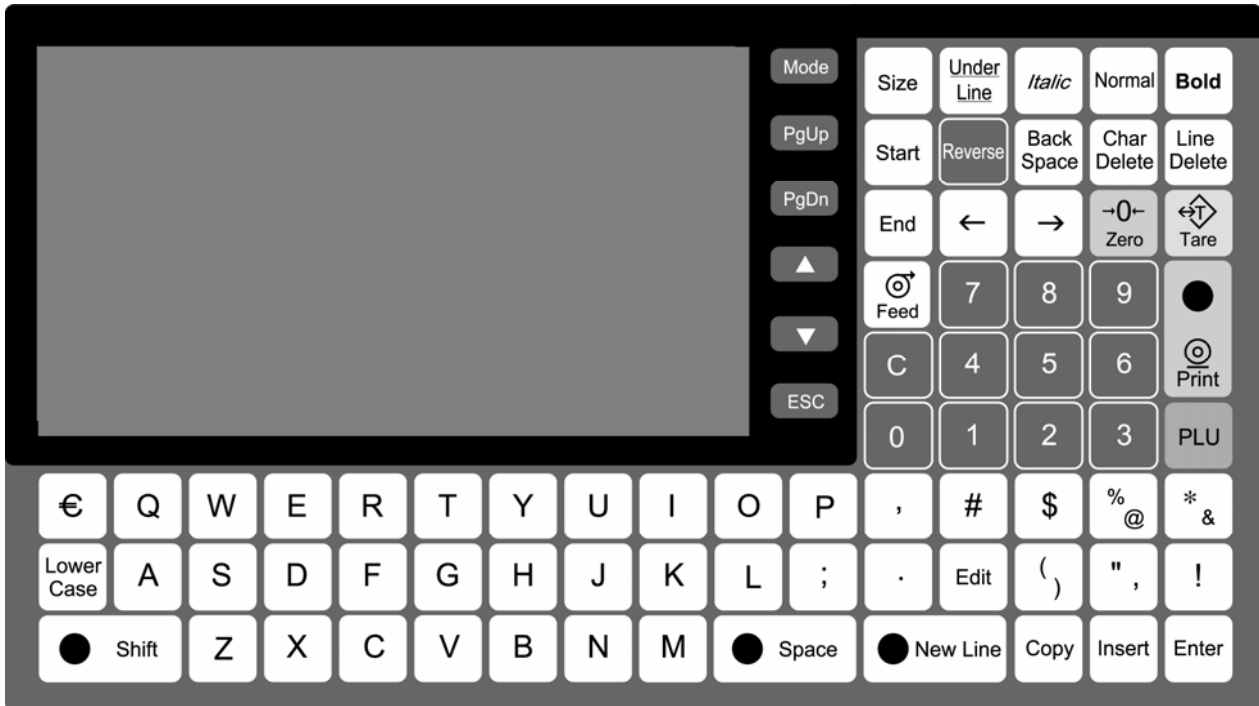

■ Text Editing Keys

	Used to delete a character by moving the cursor back by one character.		Used to select a font size for a text displayed on the screen.
	Used to delete a character at the place where the cursor is positioned.		Used to insert a character, or select characters followed by depressions of the [→] or [←] key.
	Used to delete a line text.		Used to move the cursor to right. Also used to select characters for changing the style.
	Used to specify a normal character style.		Used to move the cursor to left. Also used to select characters for changing the style.
	Used to specify a bold character style.		Used to select either lower-case or upper-case character mode for a text to be entered.



Used to specify an Italic character style.



Used to copy the original data to the current data.



Used to specify an underlined character style.



Used to finalize editing a text.



Used to specify a reversed character.



Used to begin a new character line.



Used to enter a space at the place where the cursor is positioned.



Used to select either a lower-case or upper-case mode for a character to be entered.

A.2 NORMAL CHARACTER EDITING

1. Confirm that the text edit screen is displayed.
Select a desired character size by using the [Size] key on the key sheet.

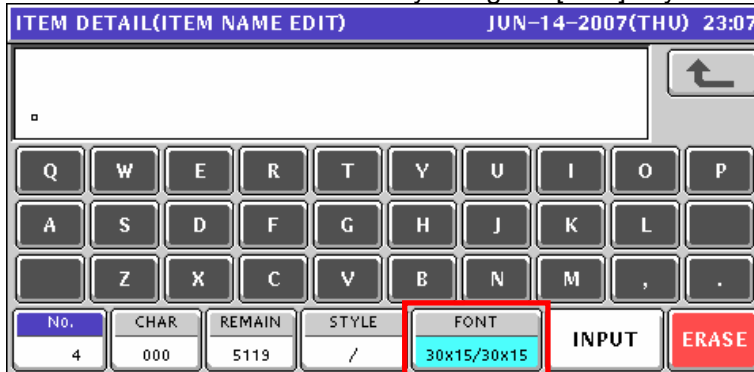

Size

The selected size is displayed in the "FONT" display field.

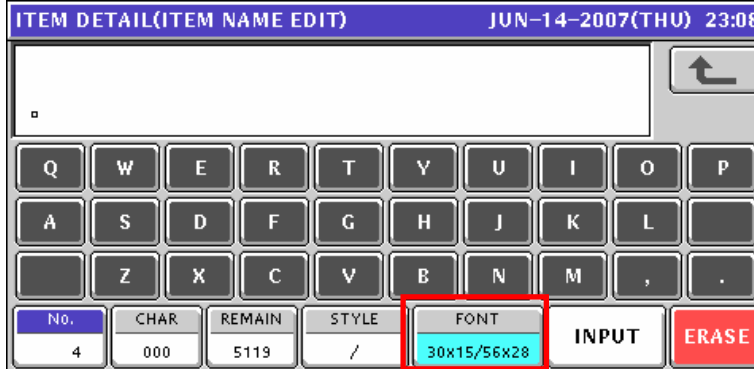

2. Press the [Lower Case] key on the key sheet to select whether to use upper-case characters or lower-case characters.



Lower Case

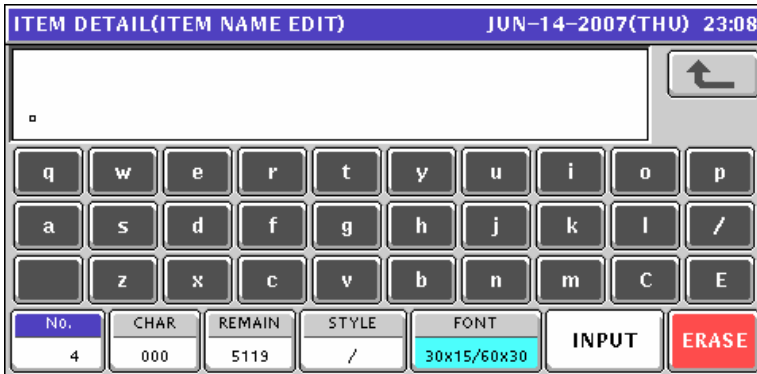

3. Enter desired characters using alpha-numeric keys on the key sheet or the screen.



Upper-case characters



Lower-case characters



4. To change to a new line, press the [New Line] key on the key sheet.



Enter desired characters.

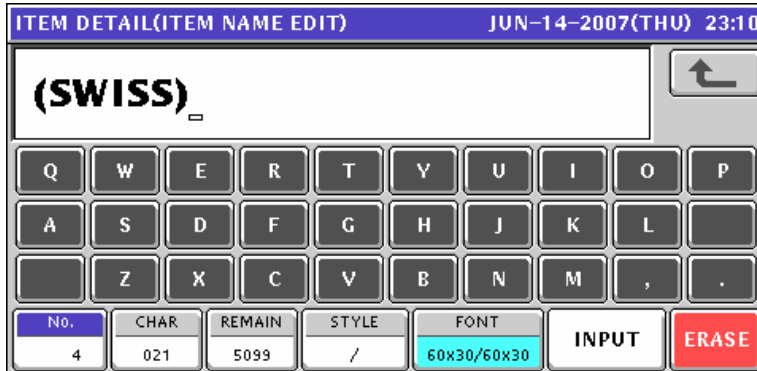

5. To finalize the editing, press the [ESC] key on the key sheet.



The confirmation screen appears. Then, press the [SAVE] button to save the data.

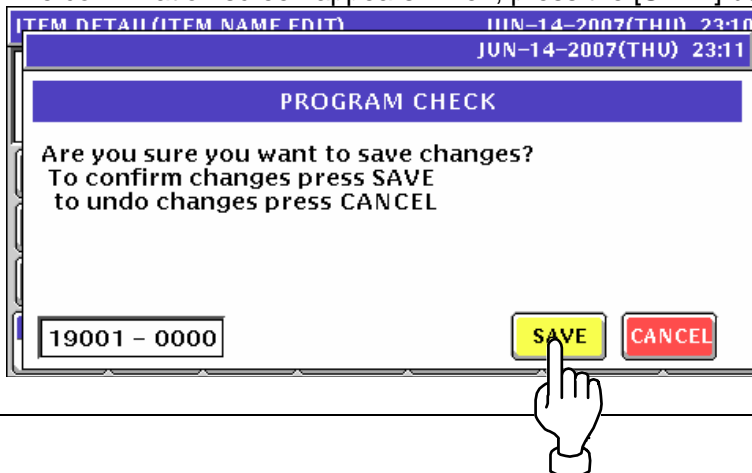

A.3 SPECIAL CHARACTER EDITING

1. Confirm that the text edit screen is displayed.

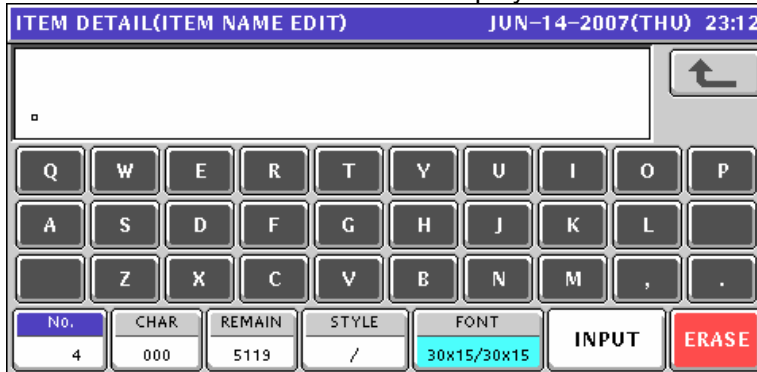

2. To select a desired character style using the following keys.



The selected style is displayed in the “STYLE” display field.

EXAMPLE

Select reversed characters.

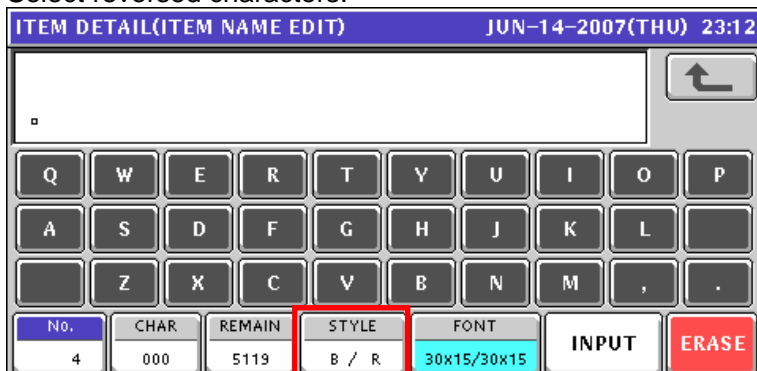

3. Enter desired characters using alpha-numeric keys on the key sheet or the screen.



4. Press the [ESC] key on the key sheet.



The confirmation screen appears. Then, press the [SAVE] button to save the data.

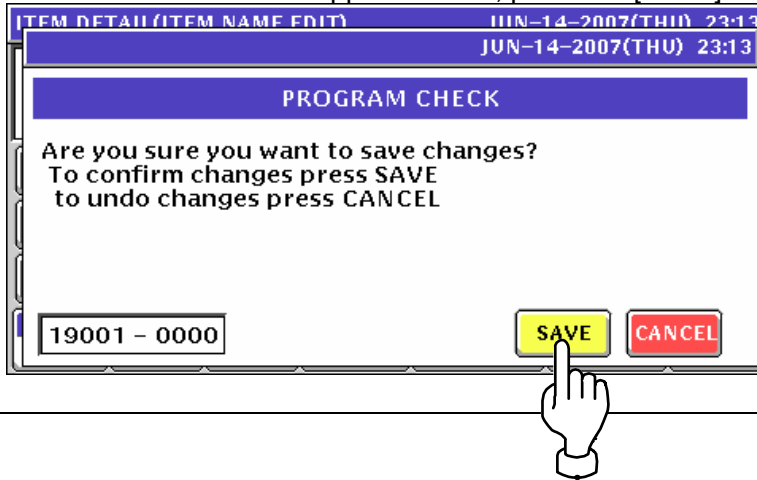

A.4 LINE DELETION

1. Confirm that the text edit screen for a desired PLU is displayed.



2. To delete the character line, press the [Line Delete] key on the key sheet.

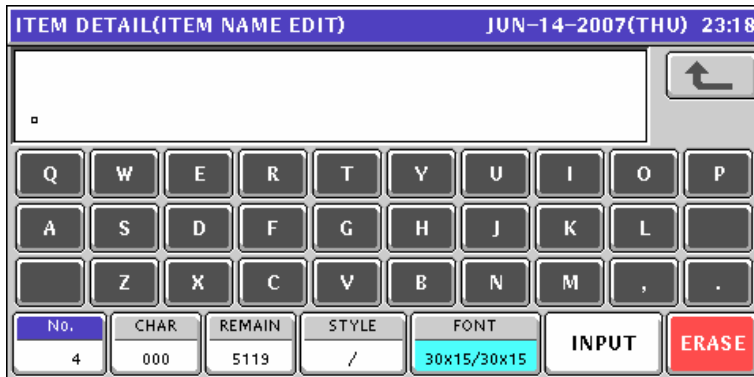

3. Press the [ESC] key on the key sheet.



The confirmation screen appears. Then, press the [SAVE] button to save the data.

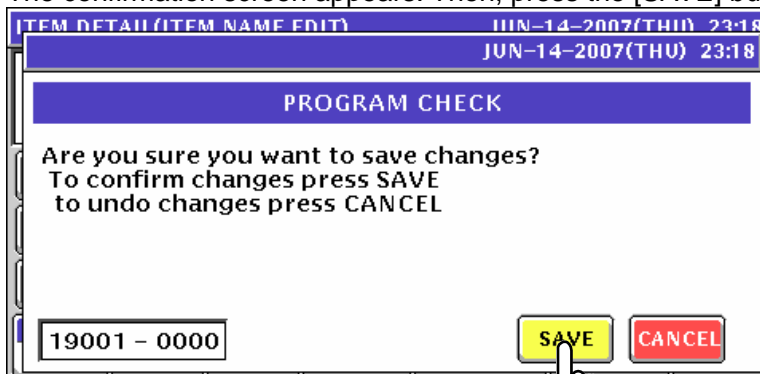

A.5 CHARACTER DELETION

1. To Make a correction for a misspelled word, move the cursor to a place where misspelling is made by using the [→] or [←] key.

EXAMPLE "GAUDA" → "GOUDA"

ITEM DETAIL(ITEM NAME EDIT)					JUN-14-2007(THU) 23:21	
GAUDA CHEESE						↵
Q	W	E	R	T	Y	U
A	S	D	F	G	H	J
	Z	X	C	V	B	N
No.	CHAR	REMAIN	STYLE	FONT	INPUT	ERASE
4	012	5107	/	30x15/30x15		

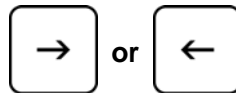

ITEM DETAIL(ITEM NAME EDIT)					JUN-14-2007(THU) 23:21	
GAUDA CHEESE						↵
Q	W	E	R	T	Y	U
A	S	D	F	G	H	J
	Z	X	C	V	B	N
No.	CHAR	REMAIN	STYLE	FONT	INPUT	ERASE
4	012	5107	/	30x15/30x15		

2. Press the [Character Delete] key on the key sheet to delete the misspelled character.

Char
Delete

ITEM DETAIL(ITEM NAME EDIT)					JUN-14-2007(THU) 23:21	
GUDA CHEESE						↵
Q	W	E	R	T	Y	U
A	S	D	F	G	H	J
	Z	X	C	V	B	N
No.	CHAR	REMAIN	STYLE	FONT	INPUT	ERASE
4	011	5108	/	30x15/30x15		

3. Enter the correct character using the alpha-numeric keys.



4. Press the [ESC] key on the key sheet.



The confirmation screen appears. Then, press the [SAVE] button to save the data.

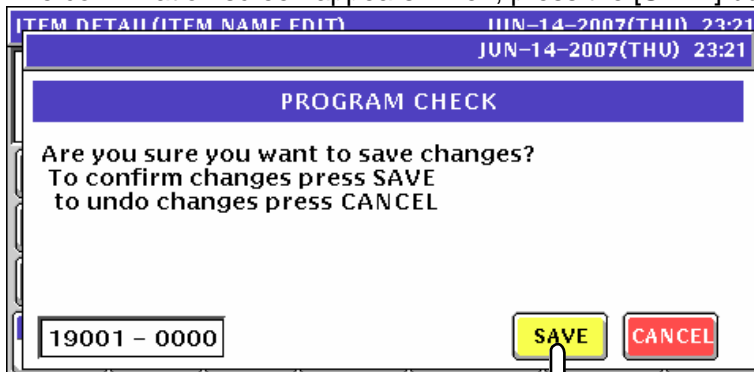

A.6 CHARACTER BACKSPACING

1. To delete a wrong character that was just entered, press the [Back Space] key on the key sheet to move the cursor back by one character.

EXAMPLE "E" → "A"

ITEM DETAIL(ITEM NAME EDIT)				JUN-14-2007(THU) 23:22					
GOUDE					↵				
Q	W	E	R	T	Y	U	I	O	P
A	S	D	F	G	H	J	K	L	
	Z	X	C	V	B	N	M	,	.
No.	CHAR	REMAIN	STYLE	FONT	INPUT	ERASE			
4	005	5114	/	30x15/30x15					

Back
Space

ITEM DETAIL(ITEM NAME EDIT)				JUN-14-2007(THU) 23:23					
GOUD					↵				
Q	W	E	R	T	Y	U	I	O	P
A	S	D	F	G	H	J	K	L	
	Z	X	C	V	B	N	M	,	.
No.	CHAR	REMAIN	STYLE	FONT	INPUT	ERASE			
4	004	5115	/	30x15/30x15					

2. Enter a correct character.

A

ITEM DETAIL(ITEM NAME EDIT)				JUN-14-2007(THU) 23:23					
GOUDA					↵				
Q	W	E	R	T	Y	U	I	O	P
A	S	D	F	G	H	J	K	L	
	Z	X	C	V	B	N	M	,	.
No.	CHAR	REMAIN	STYLE	FONT	INPUT	ERASE			
4	005	5114	/	30x15/30x15					

3. Complete the text.**4.** Press the [ESC] key on the key sheet.

The confirmation screen appears. Then, press the [SAVE] button to save the data.

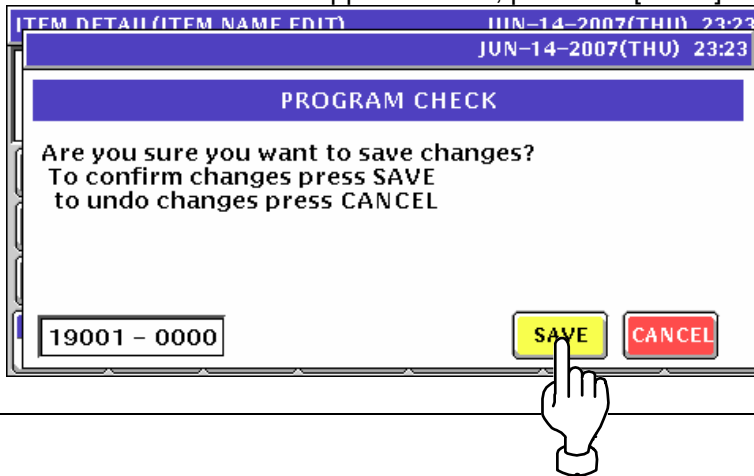



Design and specifications are subject to change without notice.

44 SANNO-CHO, SHOGOIN, SAKYO-KU
KYOTO, 606-8392 JAPAN
PHONE: 81-75-771-4141
FACSIMILE: 81-75-751-1634
URL: <http://www.ishidajapan.com>
